



## **KITCHEN + BEDROOM.**

---

Product Guide 2024



## HOUSING 002

The devil is in the details, so, to assist with the design process and ensure there is no room for error, we have visualised and categorised each kitchen and bedroom component by range to plan every detail with ease.



## IN-FRAME 010

A premium range of beautifully crafted kitchen furniture, effortlessly combining traditional looks with a subtle contemporary touch. Exceptionally high quality and distinctive design means our In-Frame kitchens will stand the test of time.



## VERSE HANDLELESS 018

The uninterrupted, smooth lines of Verse Handleless give this range a premium and contemporary look. Verse Handleless utilises an integrated aluminium rail system that creates a space between cabinets to allow opening and closing of doors and drawers.



## SHAKER 036

If your style is traditionally English, contemporary country, or naturally rustic, have a look at the kitchens in our Shaker collection. Caple's shaker kitchens are characterised by elegant details, rich woods, and subtle colours.



## J-HANDLE 072

Experience a kitchen that exudes modern elegance and sophistication. The cabinets, with their integrated 'J' style handles, not only add a touch of contemporary charm but also ensure uncluttered lines that flow throughout your space.



## SLAB 082

Transform your space with our Slab kitchen collection - a modern embodiment of simplicity and style. The sleek, plain slab doors seamlessly integrate into a contemporary setting, offering an understated charm.



## BEDROOMS 107

Embrace the moment to wind down, get comfortable, and sink into a peaceful slumber. With our bedroom range, your private retreat is thoroughly designed to maintain a clutter-free environment, ensuring the ideal ambience for your relaxation.



## HANDLES 122

Will it be contemporary linear stainless steel, or a set of traditional pewter knobs? It's amazing how these small [and essential] items can completely transform the finish of your kitchen.



# Kitchen + Bedroom Guide.

Your dream kitchen is about to become a reality. But the devil is in the details. So, to assist with the design process and ensure there is no room for error, we have visualised and categorised each kitchen component by range to plan every detail with ease.

Use this guide along with our Kitchen + Bedroom Furniture Collection to assist you with each decision and take the guesswork out of the process. Within each range, you will find a price group, the components available and whether special sizes are available to create a truly bespoke kitchen.

Relax and unwind, knowing your bedroom design is in safe hands. Browse the collection of components and create your stress-free sanctuary. Say goodbye to clutter and add accessories for an organised, accessible wardrobe.



## Kitchen Housing Units. STANDARD LAY-ON.

### 1970MM TALL HOUSINGS

Note: the guide height for Wall unit installation is 2120mm

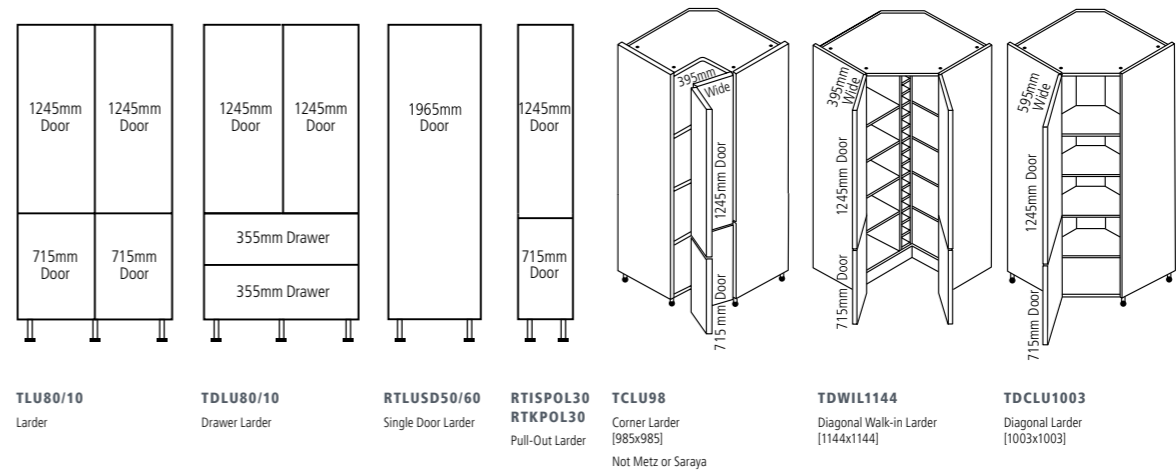
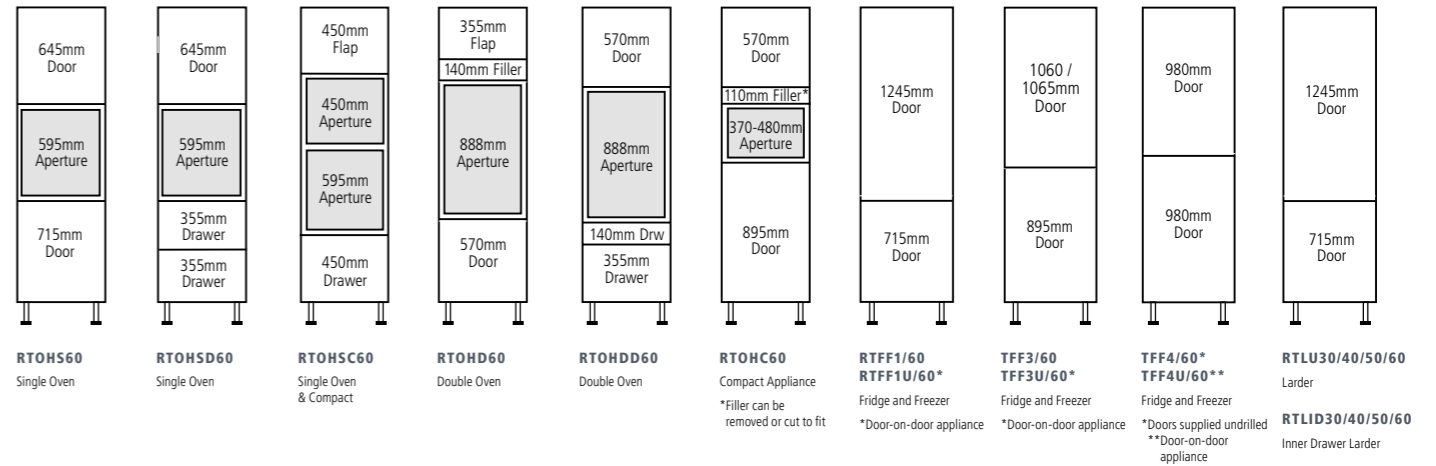

### 5PLAYED UNITS

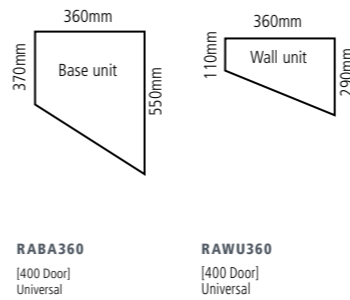

### 1250MM MIDI HOUSINGS

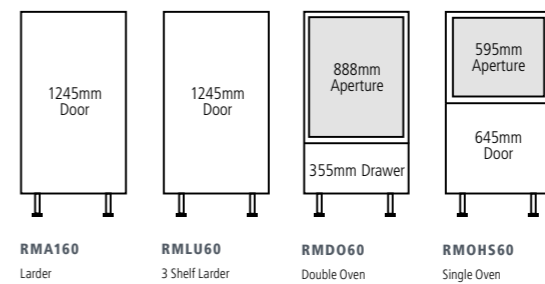

# Kitchen Housing Units. STANDARD LAY-ON.

## 2150MM TALL HOUSINGS

Note: the guide height for wall unit installation is 2300mm

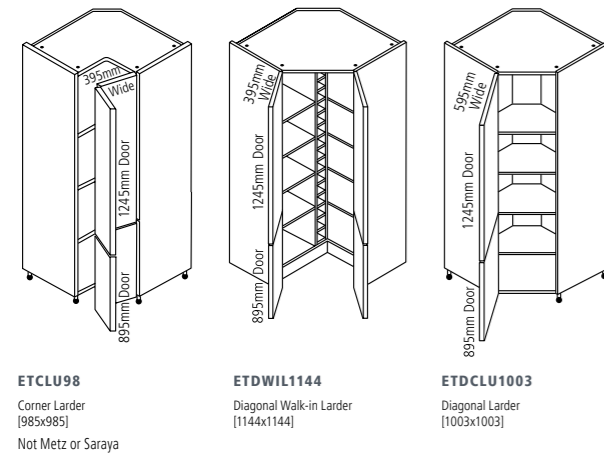

## HINTS ON CORNER PLANNING

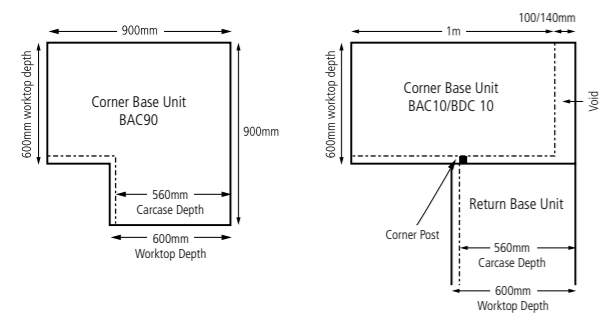

We recommend that only one working drawer should be used, with the other unit adopting either a dummy drawer front (without handle fitted) or a full height door.

**PLEASE NOTE:** Corner post widths vary from range to range, this should be considered in both design and installation.

- > All Caple kitchens are supplied with Blum Antaro full extension soft close drawer boxes and Hettich Sensys integrated soft close hinges [except integrated fridge/freezer housings] as standard
- > All horizontal wall units and tall housings which incorporate a lift-up door have Blum Aventos HK-S mechanisms
- > All standard corner bases are supplied with a blanking panel and corner post
- > All glazed units are supplied with glass shelves
- > All dimensions listed are in mm
- > Floor standing unit heights exclude plinth

# Kitchen Housing Units. VERSE HANDLELESS.

## 1970MM TALL HOUSINGS

Note: the guide height for Wall unit installation is 2120mm

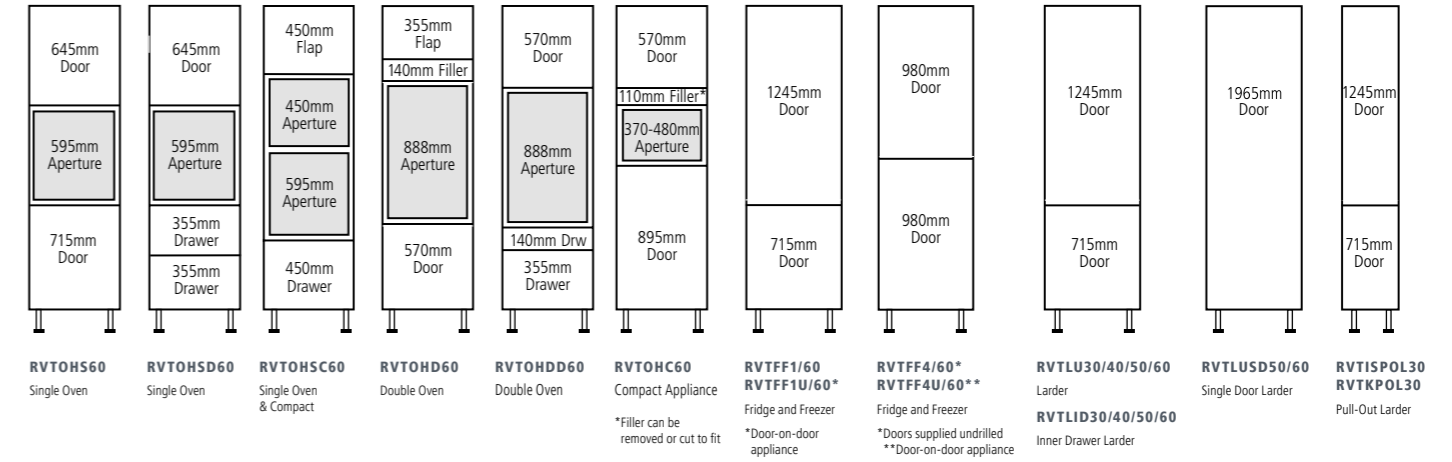

## 2150MM TALL HOUSINGS

Note: the guide height for Wall unit installation is 2300mm

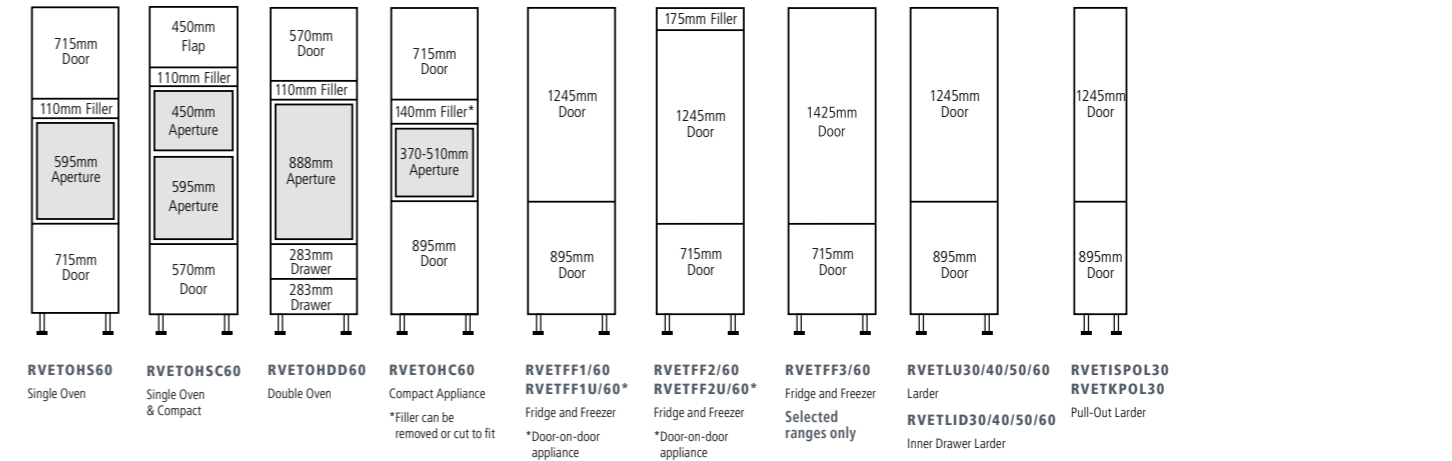

## 1250MM MIDI HOUSINGS

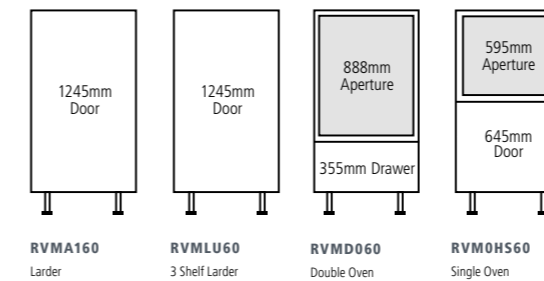

# In-Frame Housing Units. HARPTREE + SUTTON.

## TALL HOUSINGS

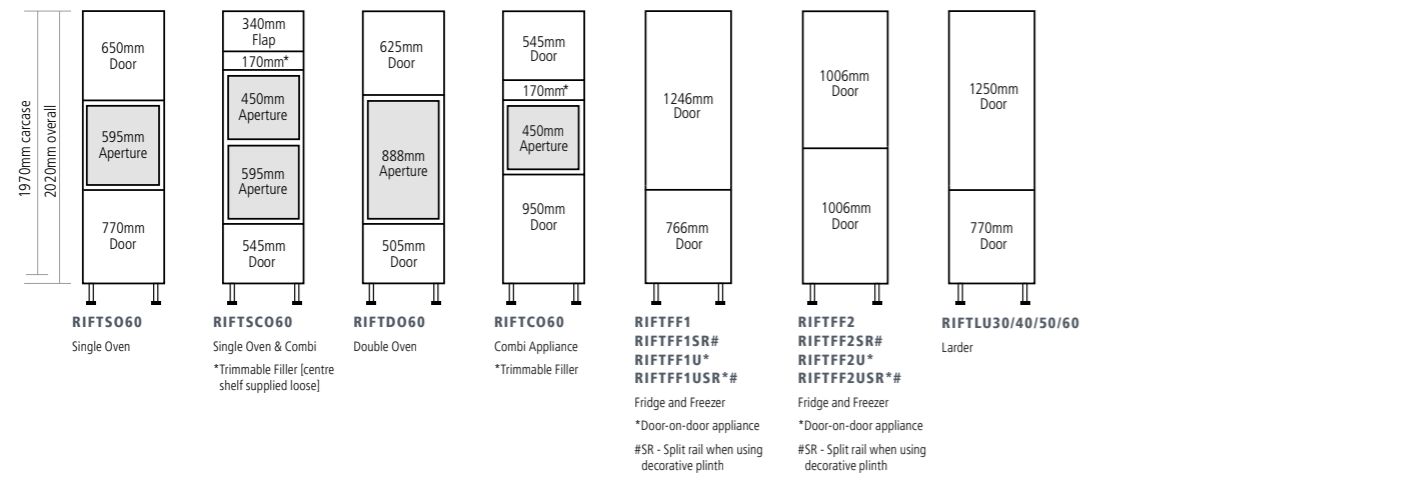

## TALL HOUSINGS

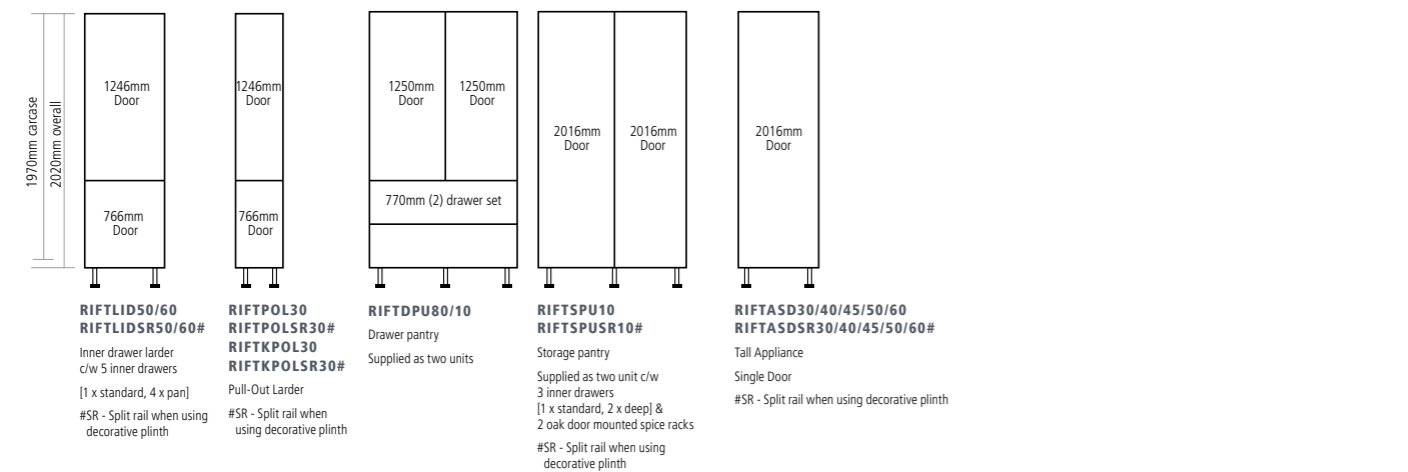

## EXTRA TALL HOUSINGS

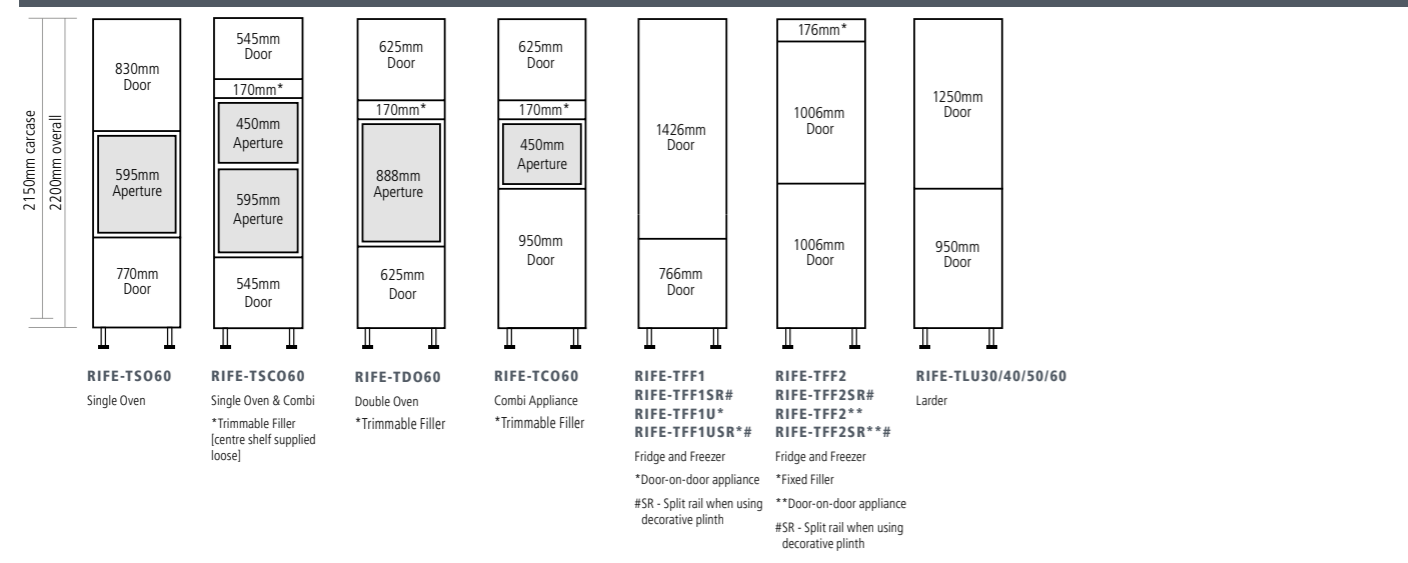

- > All Caple in-frame kitchens are supplied with oak dove-tailed drawer boxes on Blum Movento full extension soft close runners and Blum fully integrated soft close hinges [except integrated fridge/freezer housings] as standard
- > All horizontal wall units and tall housings which incorporate a lift-up door have Blum Aventos HK-XS mechanisms
- > All illustrations are a guide only
- > All standard corner bases are supplied with a blanking panel and a pre-formed 60x60 corner post
- > All glazed units are supplied with glass shelves
- > Floor standing unit heights exclude plinth
- > Special sizes available – [not available in corner door arrangements] – contact us for further information
- > All 1000mm glazed wall units [H:720/900 high] and 800,900,1000mm wall units [H:900mm] are supplied as a two frame system

# In-Frame Housing Units. WINFORD.

## TALL HOUSINGS

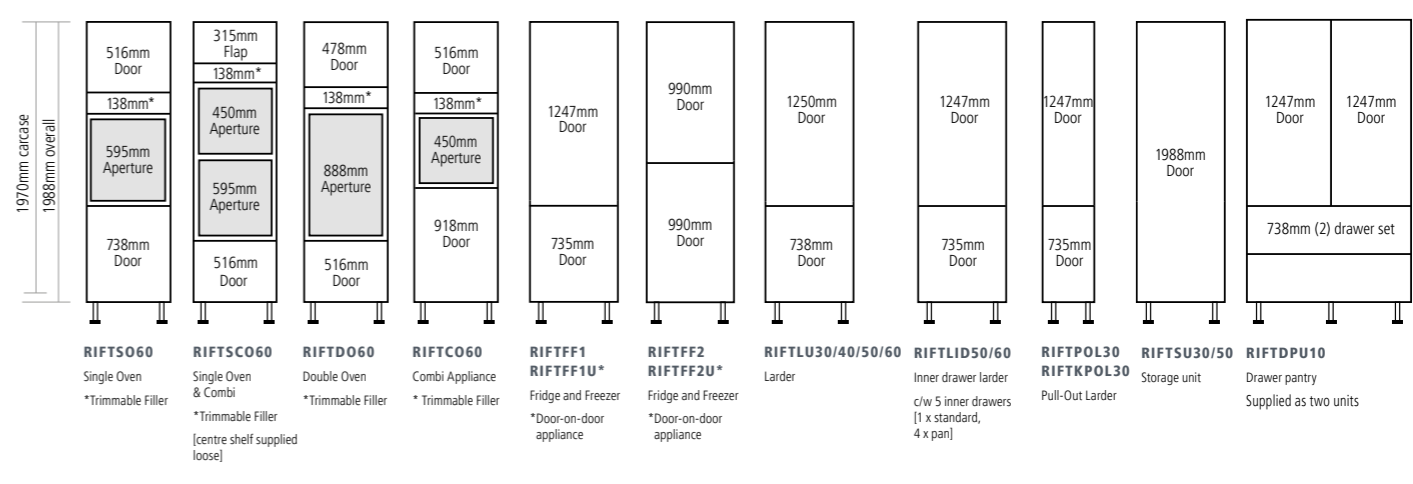

## EXTRA TALL HOUSINGS

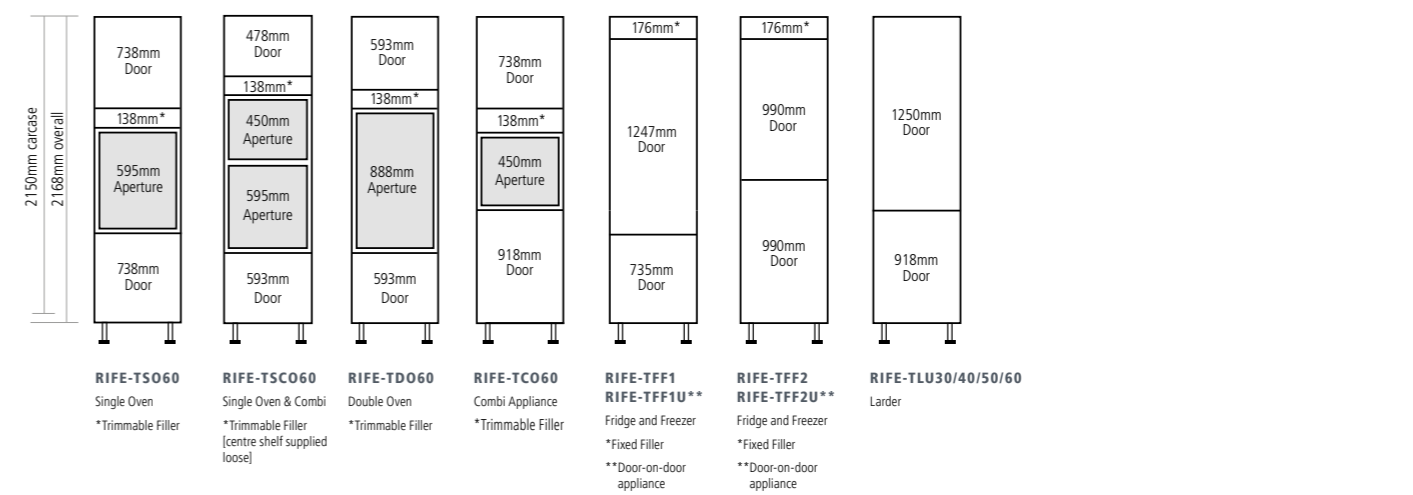

- > All Caple in-frame kitchens are supplied with oak dove-tailed drawer boxes on Blum Movento full extension soft close runners and Blum fully integrated soft close hinges [except integrated fridge/freezer housings] as standard
- > All horizontal wall units and tall housings which incorporate a lift-up door have Blum Aventos HK-XS mechanisms
- > All standard corner bases are supplied with a blanking panel and a pre-formed 60x60 corner post
- > All glazed units are supplied with glass shelves
- > Floor standing unit heights exclude plinth
- > Special sizes available – [not available in corner door, feature door or integrated appliance door sets] – contact us for further information
- > All 1000mm glazed wall units [H:720/900 high] and 800,900,1000mm wall units [H:900mm] are supplied as a two frame system
- > Curved return base units have a fixed frame system [appliance door set]

# Bedroom Housing Units.

## END ELEVATIONS

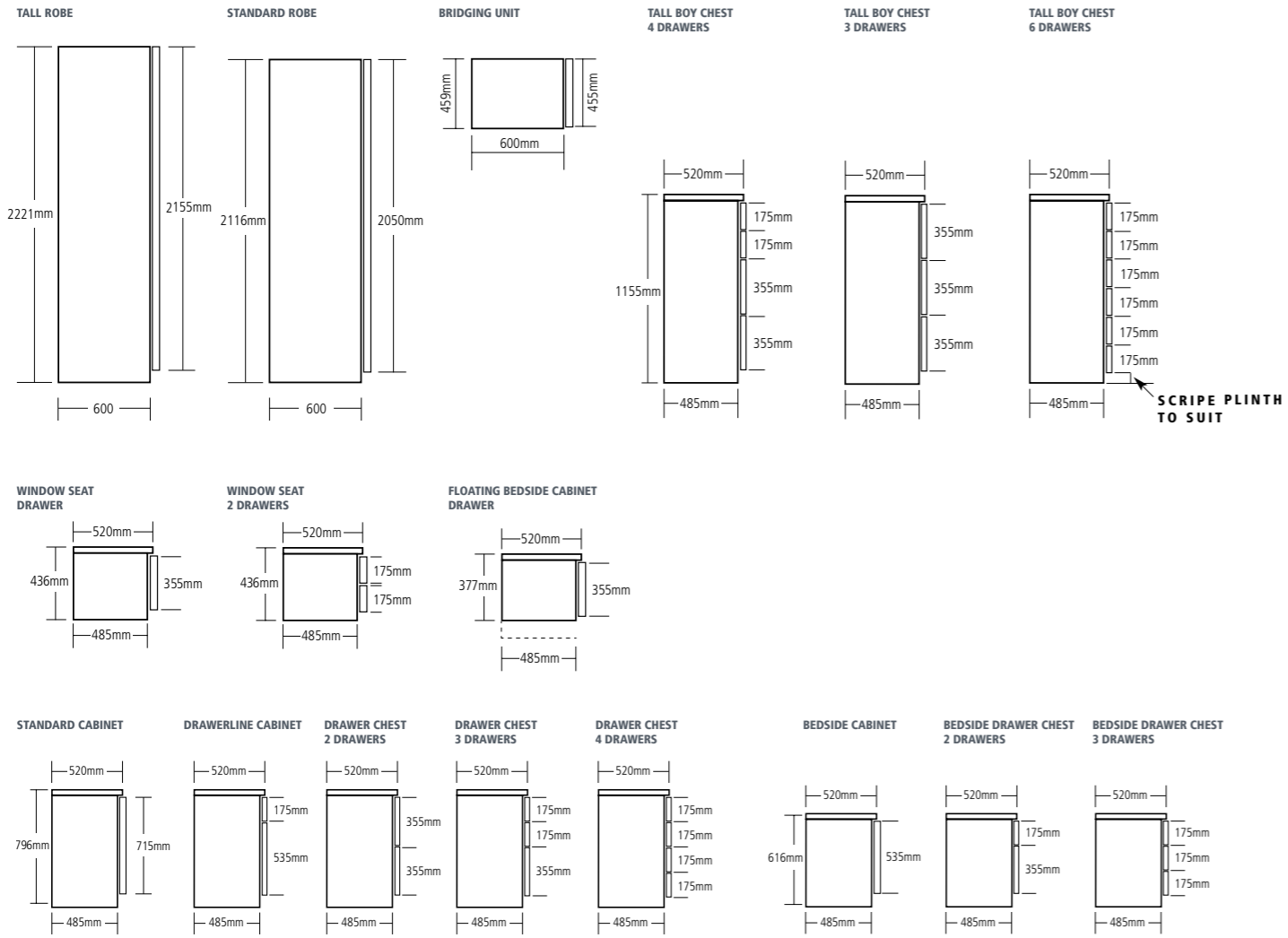

## CORNER SITUATIONS

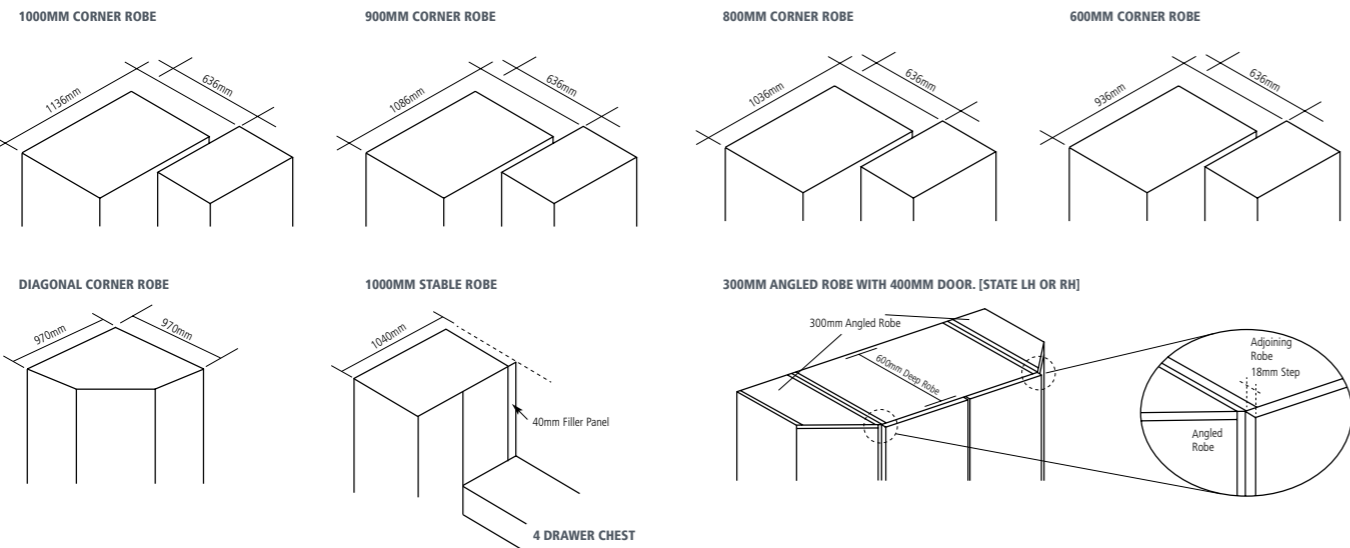



## In-Frame.

A premium range of beautifully crafted kitchen furniture, effortlessly combining traditional looks with a subtle contemporary touch.

Exceptionally high quality and distinctive design means our In-Frame kitchens will stand the test of time.

**IN-FRAME**  
**PRICE GROUP 9, 11 + 12**  
**HARPTREE**

Special sizes available  
 contact us for further information

Primed [PG9]

Colour Options [PG11]: Auburn, Black, Bone, Dusty Rose, Cashmere, Coal, Cotton, Fern, Forest, Mink, Mist, Moss, Navy, Putty, Riptide, Sea Salt, Smoke, Space, Thyme, Twilight.

Bespoke Colour Option [PG12]



**HI-LINE BASE**

CODE	WIDTH	CODE	WIDTH	CODE	WIDTH	CODE	WIDTH	CODE	WIDTH	CODE	WIDTH
<b>RIFBA30</b>	300	<b>RIFBA60</b>	600	<b>RIFBISPO15</b>	150	<b>RIFBISPOS15</b>	150	<b>RIFCDBA30</b>	300x300	<b>RIFCDBA26</b>	260
<b>RIFBA35</b>	350	<b>RIFBA80#</b>	800	Standard Mechanism inc.		<b>RIFCDBA60</b>	600x600	<b>RIFBSU30</b>	300	<b>RIFBSU60</b>	600
<b>RIFBA40</b>	400	<b>RIFBA90#</b>	900	<b>RIFBKPO15</b>	150	<b>RIFBKPOS15</b>	150	<b>RIFBSU35</b>	350	<b>RIFBSU80#</b>	800
<b>RIFBA45</b>	450	<b>RIFBA10#</b>	1000	Kesseböhmer Mechanism inc.		<b>RIFBSU40</b>	400	<b>RIFBSU45</b>	450	<b>RIFBSU90#</b>	900
<b>RIFBA50</b>	500	# 2 x Doors		<b>RIFBKTP015</b>	150	<b>RIFBKTPSR15</b>	150	<b>RIFBSU45</b>	450	<b>RIFBSU10#</b>	1000
				Kesseböhmer Mechanism & towel rail inc.				<b>RIFBSU50</b>	500	# 2 x Doors	

**HI-LINE CORNER BASE**

CODE	WIDTH	CODE	WIDTH	CODE	WIDTH	CODE	WIDTH	CODE	WIDTH	CODE	WIDTH
<b>IFCBTS207</b>	200	<b>IFSDS207</b>	200	<b>IFTS207</b>	200	<b>RIFBAC830</b>	800/300	<b>RIFBAC950</b>	900/500	<b>IFBAC90</b>	900x900
						<b>RIFBAC80</b>	800/400	<b>RIFBAC960</b>	900/600	Bi-fold hinge system	
						<b>RIFBAC845</b>	800/450	<b>RIFBAC140</b>	1000/400	Flatpack	
						<b>RIFBAC850</b>	800/500	<b>RIFBAC145</b>	1000/450	Includes drawer box and runners	
						<b>RIFBAC860</b>	800/600	<b>RIFBAC160</b>	1000/600	*Not available as a Primed Finish	
						<b>RIFBAC940</b>	900/400	<b>RIFBAC12</b>	1200/600	Ready assembled unit	
						<b>RIFBAC945</b>	900/450			# 2 x Doors	

Inc. Corner Post & Blanking Panel

**BELFAST SINK BASE**   **DRAWERLINE CORNER BASE**   **BUILT UNDER**   **2 DRAWER BASE**   **3 DRAWER BASE**   **4 DRAWER BASE**

CODE	WXH	CODE	WIDTH	CODE	WIDTH	CODE	WIDTH	CODE	WIDTH	CODE	WIDTH
<b>RIFBSU6045</b>	600x505	<b>RIFBDC830</b>	800/300	<b>RIFBDC950</b>	900/500	<b>RIFBU060</b>	600	<b>RIFBD250</b>	500	<b>RIFBD280SL</b>	800
To suit a sink height of 260-265mm		<b>RIFBDC80</b>	800/400	<b>RIFBDC960</b>	900/600			<b>RIFBD260</b>	600	<b>RIFBD290SL</b>	900
		<b>RIFBDC845</b>	800/450	<b>RIFBDC140</b>	1000/400			<b>RIFBD280</b>	800	<b>RIFBD210SL</b>	1000
		<b>RIFBSU6049</b>	600x545	<b>RIFBDC850</b>	800/500	<b>RIFBDC145</b>	1000/450	<b>RIFBD290</b>	900	<b>RIFBD210</b>	1000
		<b>RIFBSU8049</b>	800x545	<b>RIFBDC860</b>	800/600	<b>RIFBDC10</b>	1000/500	<b>RIFBD210</b>	1000		
To suit a sink height of 220-225mm		<b>RIFBDC940</b>	900/400	<b>RIFBDC160</b>	1000/600	<b>RIFBD290</b>	900				
# 2 x Doors		<b>RIFBDC945</b>	900/450	<b>RIFBDC12</b>	1200/600						

Inc. Corner Post & Blanking Panel

**4 DRAWER BASE**   **MEDIUM WALL**   **TALL WALL**

CODE	WIDTH	CODE	WIDTH	CODE	WIDTH	CODE	WIDTH	CODE	WIDTH	CODE	WIDTH
<b>RIFBD430</b>	300	<b>RIFWU30-7</b>	300	<b>RIFWG50-7</b>	500	<b>RIFCWL60-7</b>	600x600	<b>RIFWU30-9</b>	300	<b>RIFWG50-9</b>	500
<b>RIFBD440</b>	400	<b>RIFWU35-7</b>	350	<b>RIFWG10-7</b>	1000	Includes Corner Post		<b>RIFWU40-9</b>	400	<b>RIFWG10-9</b>	1000
<b>RIFBD445</b>	450	<b>RIFWU40-7</b>	400	<b>RIFWGR50-7*</b>	500	Add 'X' to the end of the code for 350mm deep		<b>RIFWU45-9</b>	450	<b>RIFWGR50-9*</b>	500
<b>RIFBD450</b>	500	<b>RIFWU45-7</b>	450	<b>RIFWGR10-7*</b>	1000	Reeded Glass		<b>RIFWU50-9</b>	500	<b>RIFWGR10-9*</b>	1000
<b>RIFBD460</b>	600	<b>RIFWU50-7</b>	500			Add 'X' to the end of the code for 350mm deep		<b>RIFWU60-9</b>	600		
4 x standard drawers		<b>RIFWU60-7</b>	600			Add 'X' to the end of the code for 350mm deep		<b>RIFWU80-9</b>	800		
		<b>RIFWU80-7</b>	800					<b>RIFWU90-9</b>	900		
		<b>RIFWU90-7</b>	900					<b>RIFWU10-9</b>	1000		
		<b>RIFWU10-7</b>	1000								

**TALL WALL**   **HORIZONTAL WALL**   **DRESSER WALL**   **TALL LARDER**

CODE	WIDTH	CODE	WIDTH	CODE	WIDTH	CODE	WIDTH	CODE	WIDTH	CODE	WIDTH
<b>IFBWU6040-9</b>	600	<b>RIFHWU6029</b>	600	<b>RIFDR50A-12</b>	500	<b>RIFDR50-13</b>	500	<b>RIFTLU30</b>	300	<b>RIFTLID50</b>	500
Flatpack		<b>RIFHWU9029</b>	900	<b>RIFDRR50A-12*</b>	500	<b>RIFDRR50-13*</b>	500	<b>RIFTLU40</b>	400	<b>RIFTLID60</b>	600
		<b>RIFHWU1029</b>	1000	1 x Full height glazed door		1 x Door and drawer		<b>RIFTLU50</b>	500		
				Add 'X' to the end of the code for 350mm deep		*Reeded Glass		<b>RIFTLU60</b>	600		

**TALL LARDER**   **TALL APPLIANCE - SINGLE DOOR**   **TALL DRAWER PANTRY**   **TALL STORAGE PANTRY**   **TALL PULL-OUT LARDER**

CODE	WIDTH	CODE	WIDTH	CODE	WIDTH	CODE	WIDTH	CODE	WIDTH	CODE	WIDTH
<b>RIFE-TLU30</b>	300	<b>RIFTASD30</b>	300	<b>RIFTASDSR30</b>	300	<b>RIFTDPU80</b>	800	<b>RIFTSPU10</b>	1000	<b>RIFTPOL30</b>	300
<b>RIFE-TLU40</b>	400	<b>RIFTASD40</b>	400	<b>RIFTASDSR40</b>	400	<b>RIFTDPU10</b>	1000	<b>RIFTSPU10*</b>	1000	<b>RIFTKPOL30</b>	300
<b>RIFE-TLU50</b>	500	<b>RIFTASD45</b>	450	<b>RIFTASDSR45</b>	450	Composed of two separate units		Composed of two separate units		<b>RIFTKPOLSR30*</b>	300
<b>RIFE-TLU60</b>	600	<b>RIFTASD50</b>	500	<b>RIFTASDSR50</b>	500	Fixed frame top doors		Fixed frame doors		*Split bottom rail when used with Decorative plinth	
		<b>RIFTASD60</b>	600	<b>RIFTASDSR60</b>	600	Split bottom rail when used with Decorative plinth		Split bottom rail when used with Decorative plinth		*Split bottom rail when used with Decorative plinth	

**TALL DOUBLE OVEN**   **TALL SINGLE OVEN**   **TALL SINGLE OVEN + COMBI**   **TALL COMBI**   **TALL FRIDGE/FREEZER**

CODE	WIDTH	CODE	WIDTH	CODE	WIDTH	CODE	WIDTH	CODE	WIDTH	CODE	WIDTH
<b>RIFTDO60*</b>	600	<b>RIFTSO60*</b>	600	<b>RIFTSO60*</b>	600	<b>RIFTCO60*</b>	600	<b>RIFTF1</b>	600	<b>RIFTF1SR</b>	600
<b>RIFE-TDO60</b>	600	<b>RIFE-TSO60</b>	600	<b>RIFE-TSCO60</b>	600	<b>RIFE-TCO60</b>	600	<b>RIFTF2</b>	600	<b>RIFTF2SR</b>	600
				Mechanism inc.				<b>RIFTF1U*</b>	600	<b>RIFTF1USR*</b>	600
								<b>RIFTF2U*</b>	600	<b>RIFTF2USR*</b>	600

**END SUPPORT PANELS**   **CARCASE MFC PANELS**   **CORNICE**   **PLINTH + LEGS**

CODE	WXH	CODE	WXH	CODE	WXH	CODE	WXH	CODE	WXH	CODE	WXH
<b>ESP</b>	600x900	<b>1970/300</b>	300x1970	<b>UG/DOET</b>	1000x22	<b>CO4/B</b>	3000x90	<b>COMU/B</b>	3000x50	<b>CEC3/B</b>	395x395
MFC Carcase	700x900	<b>2150/560</b>	560x2150	*Un-glued 1m carcass edging		Door Finish	Door Finish	Door Finish	Use in conjunction with CO4/B	Door Finish	Use in conjunction with CO4/B
		<b>2350/660</b>	660x2350								
		<b>720/300</b>	300x720								
		<b>900/2000</b>	2000x900								
		<b>900/300</b>	300x900								

**PLINTH + LEGS**   **PLANT ON END PANELS**

CODE	WXH	CODE	LENGTH	CODE	LENGTH	CODE	LENGTH	CODE	WXH	CODE	WXH
<b>CPL2/B</b>	2440x132	<b>CPLS2/B</b>	525x525	<b>DPL/B</b>	3000	<b>DCPLS/B</b>	609x609	<b>PST</b>	3000	<b>2440/350PS/B</b>	350x2440
Door Finish	Use in conjunction with RIFCDBA30	Door Finish	Use in conjunction with RIFCDBA60	Door Finish	Door Finish	Door Finish	Use in conjunction with RIFCDBA30	Door Finish	Use in conjunction with RIFCDBA60	<b>2440/650PS/B</b>	650x2440
										<b>950/350PS/B</b>	350x950
										<b>885/650PS/B</b>	650x885
										<b>900/908PS/B</b>	908x900
										<b>900/1168PS/B</b>	1168x900
										<b>900/2000PS/B</b>	2000x900

**PILASTERS**   **FURNITURE ACCESSORIES**

CODE	WXH	CODE	WXH	CODE	WXH	CODE	WXD	CODE	WXD	CODE	WXD
<b>PIL/SC910B</b>	50x910	<b>PIL/SCW910B</b>	72x910	<b>CP/B**4</b>	60x60	<b>MMS/B*</b>	2400x232	<b>SMS/B*</b>	2200x150	<b>MS/B*</b>	2400x200
Door Finish	Door Finish	Door Finish	Door Finish	Door Finish	Door Finish	*Specify length required	*Specify length required	*Specify length required	*Specify length required		

**FURNITURE ACCESSORIES**   **INTEGRATED DOORS**   **WINE CABINET DOOR**   **CUTLERY TRAY**   **SPARE DOOR FITTINGS**   **GENERAL ACCESSORIES**

CODE	WXD	CODE	WXD	CODE	WXH	CODE	WXH	CODE	WXD	CODE	WXD
<b>2400/90S/19B</b>	19x90	<b>DHSR/BNO</b>	350x106	<b>IFAD45F</b>	446x766	<b>IFWCD607</b>	596x766	<b>IFOAKCUT*</b>	600x408	<b>BLIFHPH</b>	
Door Finish	Door Finish	Only suitable for a 500mm wide door		Full height	To suit a Caple W16161 wine cabinet	Painted Care Kit				<b>STPWV</b>	Set of 2
				<b>IFAD60S</b>	596x621					<b>TOUCH/B</b>	
				<b>IFAD60DD</b>	596x766					<b>BLIDHPSC</b>	1/2 Litre Paint
				Full height [drawerline effect]						<b>HINGE90</b>	
				<b>IFADW60F</b>	596x766					<b>BLIDHPSC</b>	Blum Inner Drawer Hinge & Plate
				Full height [split rail for a dishwasher]						<b>MS/B*</b>	Painted Care Kit

Note: Furniture codes beginning with the letter 'R' are assembled (rigid), by removing the 'R' the units are supplied unassembled (flat-pack).

Note: Furniture codes beginning with the letter 'R' are assembled (rigid), by removing the 'R' the units are supplied unassembled (flat-pack).





**IN-FRAME**  
PRICE GROUP 9, 11 + 12  
**WINFORD**

Special sizes available  
contact us for further information

Primed [PG9]

Colour Options [PG11]: Auburn, Black, Bone, Dusty Rose, Cashmere,  
Coal, Cotton, Fern, Forest, Mink, Mist, Moss, Navy, Putty, Riptide,  
Sea Salt, Smoke, Space, Thyme, Twilight.

Bespoke Colour Option [PG12]



**HI-LINE BASE**

Pull-Out		Curved Door		Curved Return [300mm deep]		Shallow Base [300mm deep]		Spice Drawer Set	
H:738mm		H:738mm		H:735mm		H:738mm		H:738mm	
CODE	WIDTH	CODE	WIDTH	CODE	WIDTH	CODE	WIDTH	CODE	WIDTH
RIFBA30	300	RIFBA60	600	RIFBISPO15	150	RIFCBA30	300x300	RIFSBU30	300
RIFBA35	350	RIFBA80#	800	Standard Mechanism inc.		RIFCBA26	260	RIFSBU35	350
RIFBA40	400	RIFBA90#	900	RIFBKPO15	150	Fixed frame door		RIFSBU40	400
RIFBA45	450	RIFBA10#	1000	Kesseböhmer Mechanism inc.				RIFSBU45	450
RIFBA50	500	# 2 x Doors		RIFBKTP015	150			RIFSBU50	500
				Kesseböhmer Mechanism & towel rail inc.					
				Fixed frame door					

HI-LINE BASE		LOW BASE		HI-LINE CORNER BASE		DRAWERLINE BASE	
H:738mm		H:593mm		H:738mm		H:738mm	
CODE	WIDTH	CODE	WIDTH	CODE	WIDTH	CODE	WIDTH
IFTS207	200	RIFBOS60	600	RIFBAC830	800/300	RIFBD30	300
		RIFBOS10	1000	RIFBAC80	800/400	RIFBD40	400
		Veneered frame with MFC Carcase		RIFBAC845	800/450	RIFBD45	450
		Ready assembled unit		RIFBAC850	800/500	RIFBD50	500
				RIFBAC860	800/600	RIFBD60	600
				RIFBAC890	900/400	RIFBD80#	800
				RIFBAC945	900/450	RIFBD90#	900
						RIFBD10#	1000
						# 2 x Doors	

DRAWERLINE BASE		BELFAST SINK BASE		DRAWERLINE CORNER BASE		BUILT UNDER OVEN		2 DRAWER BASE	
H:738mm		H:870mm		H:738mm		H:738mm		H:738mm	
CODE	WIDTH	CODE	WIDTH	CODE	WIDTH	CODE	WIDTH	CODE	WIDTH
RIFAC10	1000	OEU12*	1170x500	RIFBSU6046	600x478	RIFBDC830	800/300	RIFBD250	500
		OEU12*	1170x500	To suit a sink height of 255-260mm		RIFBDC80	800/400	RIFBD260	600
		Includes drawer box and runners		RIFBSU6050	600x516	RIFBDC845	800/450	RIFBD280	800
		*Not available as a Primed Finish		RIFBSU8050#	800x516	RIFBDC850	800/500	RIFBD290	900
		Ready assembled unit		To suit a sink height of 217-222mm		RIFBDC860	800/600	RIFBD210	1000
				# 2 x Doors		RIFBDC940	900/400		
						RIFBDC945	900/450		

3 DRAWER BASE		4 DRAWER BASE		MEDIUM WALL		'L' Shaped Corner		Standard Corner		Curved Door	
H:738mm		H:738mm		H:738mm		H:738mm		H:738mm		H:738mm	
CODE	WIDTH	CODE	WIDTH	CODE	WIDTH	CODE	WIDTH	CODE	WIDTH	CODE	WIDTH
RIFBD350	500	RIFBD430	300	RIFWU30-7	300	RIFWU60-7	600	RIFWU60-7	600	RIFCWU30-7	300x300
RIFBD360	600	RIFBD440	400	RIFWU35-7	350	RIFWU80-7#	800	RIFWU80-7#	800		
RIFBD380	800	RIFBD445	450	RIFWU40-7	400	RIFWU90-7#	900	RIFWU90-7#	900		
RIFBD390	900	RIFBD450	500	RIFWU45-7	450	RIFWU10-7#	1000	RIFWU10-7#	1000		
RIFBD310	1000	RIFBD460	600	RIFWU50-7	500	# 2 x Doors		# 2 x Doors			
1 x standard		4 x standard drawers		Add 'X' to the end of the code for 350mm deep							
2 x deep drawers											

MEDIUM WALL		TALL WALL		HORIZONTAL WALL		DRESSER WALL		DRESSER WALL	
H:738mm		H:918mm		H:308mm		H:1210mm		H:1210mm	
CODE	WIDTH	CODE	WIDTH	CODE	WIDTH	CODE	WIDTH	CODE	WIDTH
RIFWOS60-7	600	RIFWU30-9	300	RIFHWU6029	600	RIFR50B-12	500	RIFDR10-12	1000
RIFWOS10-7	1000	RIFWU40-9	400	RIFHWU9029	900	Mechanism inc.		Add 'X' to the end of the code for 350mm deep	
Veneered frame with MFC Carcase		RIFWU45-9	450	RIFHWU1029	1000	Add 'X' to the end of the code for 350mm deep			
		RIFWU50-9	500	Mechanism inc.					
		RIFWU60-9	600	Add 'X' to the end of the code for 350mm deep					
		RIFWU80-9#	800						
		RIFWU90-9#	900						
		RIFWU10-9#	1000						
		# 2 x Doors							
		Add 'X' to the end of the code for 350mm deep							

Note: Furniture codes beginning with the letter 'R' are assembled (rigid), by removing the 'R' the units are supplied unassembled (flat-pack).

TALL LARDER		Inner Drawers		TALL DRAWER PANTRY		TALL STORAGE UNIT		TALL PULL-OUT LARDER		TALL DOUBLE OVEN	
H:1988mm		H:1988mm		H:1988mm		H:1988mm		H:1988mm		H:1988mm*	
CODE	WIDTH	CODE	WIDTH	CODE	WIDTH	CODE	WIDTH	CODE	WIDTH	CODE	WIDTH
RIFTLU30	300	RIFLID50	500	RIFE-TLU30	300	RIFTSU30	300	RIFTPOL30	300	RIFTD060*	600
RIFTLU40	400	RIFLID60	600	RIFE-TLU40	400	Composed of two separate units		RIFTSU50	500	Standard Mechanism inc.	
RIFTLU50	500			RIFE-TLU50	500	Fixed frame top doors				RIFTKPOL30	300
RIFTLU60	600			RIFE-TLU60	600					Kesseböhmer Mechanism inc.	
										Fixed frame doors	

TALL SINGLE OVEN		TALL SINGLE OVEN + COMBI		TALL COMBI		TALL FRIDGE/FREEZER		END SUPPORT PANELS		CARCASE MFC PANELS	
H:1988mm*		H:1988mm*		H:1988mm*		H:1988mm		H:1988mm		H:1988mm*	
CODE	WIDTH	CODE	WIDTH	CODE	WIDTH	CODE	WIDTH	CODE	WXH	CODE	WXH
RIFTSO60*	600	RIFTSO60*	600	RIFTCO60*	600	RIFTF2	600	ESP	600x900	1970/300	300x1970
RIFE-TSO60	600	Mechanism inc.		RIFE-TCO60	600	RIFTF2	600	900/700	700x900	2150/560	560x2150
								MFC Carcase		2350/660	660x2350
										720/300	300x720
										900/2000	2000x900
										900/300	300x900
										MFC Carcase	
										UG/DOET	1000x22
										*Un-glued 1m carcase edging	

CORNICHE		LIGHT BAFFLE		PLINTH + LEGS	
Classic		Veneered		CODE	LENGTH
Contemporary		CODE	LENGTH	PL/B	2440
Curved External Classic Section		Includes sealing strip		VF/B	3000
Curved External Combi Section		Finished long edges [plinth and/or filler]		Door finish	
CODE	WXH	CODE	WIDTH		
COCL/B	3000x80	LB/B	3000		
Door Finish		Door Finish			

PLINTH + LEGS		PLANT ON END PANELS	
Curved Plinth		18mm Tongue & Grooved Reversible	
Clear Sealing Strip		18mm Plain Reversible	
CODE	LENGTH	CODE	WXH
CPL/B	2440	2440/390T/B	390x2440
		2440/650T/B	650x2440
		950/390T/B	390x950
		885/650T/B	650x885
		Painted	
		T&G face has the superior finish	
		NOT Bone, Cotton, Fern, Putty, Riptide, Space & Twilight	

PILASTERS		FURNITURE ACCESSORIES	
Square		Pre-formed Corner Post	
Square Chamfered		Mantle Shelf	
Square Wide Chamfered		Decorative Corbel	
Curved		Corbel Back Support	
CODE	WXH	CODE	WXD
PIL/S910B	50x910	CP/B**3	60x60
Door Finish		MS/B	2400x200
		Specify length required	

FURNITURE ACCESSORIES		INTEGRATED DOORS		WINE CABINET DOOR		CUTLERY TRAY		SPARE DOOR FITTINGS		GENERAL ACCESSORIES	
19mm Spacer Fillet		Fixed Frame Doors		Wine Cabinet Door		Cutlery Tray		Blum Softclose In-Frame Door Hinge & Plate		Door Strapping Plates	
CODE	WIDTH	CODE	WXH	CODE	WXH	CODE	WXD	BLSTAYHKXS	Blum Aventos HK-XS Stay	TOUCH/B	1/2 Litre Paint
2400/90/19B	19	IFAD45F	447x735	IFWCD607	596x735	IFOAKCUT*	600x408	HINGE90	Non Softclose hinge pack [pair]	PCC/B	Painted Care Kit
Door Finish		IFAD60F	597x735	To suit a Caple Wi6161 wine cabinet		Suits drawer 400-600		BLSTAYHKXS	Decorative Blackened Copper Hinge	LEGSET	Spare black adjustable legs
		IFAD45DD	446x735					DBHC	Decorative Chrome Hinge		
		IFAD60DD	597x735					DBHC	Decorative Chrome Hinge		
		Full height drawer line effect						LEGSET	Spare black adjustable legs		
		IFAD60S	597x590								
		Semi-integrated									

Note: Furniture codes beginning with the letter 'R' are assembled (rigid), by removing the 'R' the units are supplied unassembled (flat-pack).

AT A GLANCE

# VERSE HANDLELESS



Introducing Verse, the handleless collection from Caple.

The uninterrupted, smooth lines give this range a premium and contemporary look with no need for handles. Verse utilises an integrated aluminium rail system that creates a space between cabinets to allow opening and closing of doors and drawers.

A choice of on-trend textured, matt, gloss and painted door finishes with a variety of complementary rail colours, Verse gives you complete freedom with design.

## 12 RAIL COLOURS



## BESPOKE PAINTED COLOUR

Our bespoke painted colour service means we can match your chosen Verse furniture to any paint manufacturer's colour swatch. Let your imagination run wild and choose something which will inspire you.



VERSE  
**PRICE GROUP 2**  
**BRAVA**  
*Special sizes available*  
 contact us for further information  
 Colours Options [PG2]: Concrete, Dark Oak and Rustic Iron.



**HI-LINE BASE** **HI-LINE CORNER BASE**

Pull-Out				Shallow Base [300mm deep]				'L' Shaped			
H:720mm CODE	WIDTH	CODE	WIDTH	H:720mm CODE	WIDTH	H:720mm CODE	WIDTH	H:720mm CODE	WIDTH	H:720mm CODE	WIDTH
RVBA15	150	RVBA70	700	RVBISPO15	150	RVSBU30	300	RVSBU70	700	VBAC90	900x900
RVBA30	300	RVBA80	800	Standard Mechanism inc.		RVSBU35	350	RVSBU80	800	Bi-fold hinge system	
RVBA35	350	RVBA90	900	RVBKPO15	150	RVSBU40	400	RVSBU90	900	Flatpack	
RVBA40	400	RVBA10	1000	Kesseböhmer Mechanism inc.		RVSBU45	450	RVSBU10	1000		
RVBA45	450	RVBA12	1200	RVBKTP015	150	RVSBU50	500				
RVBA50	500			Kesseböhmer Mechanism & Towel rail inc.		RVSBU60	600				
RVBA60	600										

**BUILT UNDER OVEN** **2 DRAWER BASE** **3 DRAWER BASE** **LOW WALL** **MEDIUM WALL**

BUILT UNDER OVEN		2 DRAWER BASE		3 DRAWER BASE		LOW WALL		MEDIUM WALL	
H:720mm CODE	WIDTH	H:720mm CODE	WIDTH	H:720mm CODE	WIDTH	H:575mm CODE	WIDTH	D:300mm CODE	WIDTH
RBUEG0*	600	RVBD250	500	RVBD350	500	RVWU30-5	300	RVWU80-5	800
*Non-verse spec.		RVBD260	600	RVBD360	600	RVWU40-5	400	RVWU90-5	900
		RVBD280	800	RVBD380	800	RVWU45-5	450	RVWU10-5	1000
		RVBD290	900	RVBD390	900	RVWU50-5	500		
		RVBD310	1000	RVBD410	1000	RVWU60-5	600		
		2x325mm Drawers		2x160mm, 1x325mm Drawers					

Add 'X' to the end of the code for 350mm deep

**MEDIUM WALL** **TALL WALL** **HORIZONTAL WALL**

'L' Shaped Corner		Bi-Fold		Boiler	
H:720mm CODE	D:300mm WIDTH	H:720mm CODE	D:300mm WIDTH	H:900mm CODE	D:300mm WIDTH
RVWL60-7	600x600	RVBFWU50-7	500	RVWU30-9	300
Add 'X' to the end of the code for 350mm deep [650x650]		RVBFWU60-7	600	RVWU40-9	400
Bi-Fold Hinge System		RVBFWU80-7	800	RVWU45-9	450
		RVBFWU90-7	900	RVWU50-9	500
		RVBFWU10-7	1000	RVWU60-9	600
		Mechanism inc.			

Add 'X' to the end of the code for 350mm deep

**MIDI UNITS** **LARDER** **PULL-OUT LARDER** **INNER DRAWER LARDER**

MIDI UNITS		LARDER		PULL-OUT LARDER		INNER DRAWER LARDER	
H:1250mm CODE	WIDTH	H:1970mm CODE	WIDTH	H:1970mm CODE	WIDTH	H:1970mm CODE	WIDTH
RVRMLU60	600	RVTLU30	300	RVTPOL30	300	RVTLID30	300
RVMDO60	600	RVTLU40	400	RVTKPOL30	300	RVTLID40	400
RVMOH560	600	RVTLU50	500	Standard Mechanism inc.		RVTLID50	500
		RVTLU60	600	RVETISPOL30*	300	RVTLID60	600
				RVETKPOL30*	300		
				Kesseböhmer Mechanism inc.			

1x Standard, 4x Deep Drawers

**DOUBLE OVEN** **SINGLE OVEN** **SINGLE OVEN + COMPACT** **COMPACT** **FRIDGE + FRIDGE/FREEZER**

DOUBLE OVEN		SINGLE OVEN		SINGLE OVEN + COMPACT		COMPACT		FRIDGE + FRIDGE/FREEZER	
H:1970mm CODE	WIDTH	H:1970mm CODE	WIDTH	H:1970mm CODE	WIDTH	H:1970mm CODE	WIDTH	H:1970mm CODE	WIDTH
RVTOHD60	600	RVTOHS60	600	RVTOHSC60	600	RVTOHC60	600	RVTF1U/60	600
RVTOHD60	600	RVTOHS60	600	RVTOHSC60*	600	RVTOHC60*	600	RVTF4U/60*	600
RVTOHD60*	600	RVTOHS60*	600					RVTF1U/60*	600
								RVTF4U/60*	600
								*Doors undrilled	
								*For door on door appliances	

Note: Furniture codes beginning with the letter 'R' are assembled (rigid), by removing the 'R' the units are supplied unassembled (flat-pack).

**END SUPPORT PANELS** **CARCASE MFC PANELS** **COMBI** **PLINTH** **PLANT ON END PANELS**

END SUPPORT PANELS		CARCASE MFC PANELS		COMBI		PLINTH		PLANT ON END PANELS	
H:900mm CODE	WIDTH	CODE	WXH	CODE	WXH	CODE	WIDTH	CODE	WXH
ESP	600	1970/300	300x1970	UG/**ET	1000x22	PCMB/B	2700	PL	2940
900/700	700	2150/560	560x2150	Un-Glued 1m Carcase Edging		Door Finish		Melamine [Carcase MFC]	
MFC Carcase		2350/660	660x2350	5ET/B	5000x29			PL/B	2700
		720/300	300x720	Un-glued 5M roll - Door Finish				Door Finish	
		900/2000	2000x900						
		900/300	300x900						
		MFC Carcase							

**PLANT ON END PANELS** **FURNITURE ACCESSORIES** **INTEGRATED DOORS** **SPARE DOOR FITTINGS** **GENERAL ACCESSORIES**

PLANT ON END PANELS		FURNITURE ACCESSORIES		INTEGRATED DOORS		SPARE DOOR FITTINGS		GENERAL ACCESSORIES	
22mm Breakfast Bar Panel	50mm Mitred End Panel	Corner Post [Spare]	Undrilled	Hinges [Hettich Soft Close]					
CODE	HxW	CODE	WXH	CODE	WXH	CODE	WIDTH	CODE	WXH
900/2400/22B	900x2400	MBEPA/B	604x684	INT4568	446x684	STPNW	Set of 2	STPNW	Set of 2
Door finish		MBEPB/B	604x325	INT4571	446x715	Door strapping plates		Door strapping plates	
		Base run		INT6045	596x450	LEGSET	Set of 4	LEGSET	Set of 4
		MIEP9A/B	908x684			Adjustable legs		Adjustable legs	
		MIEP9B/B	908x325						
		MIEP12A/B	1168x684						
		MIEP12B/B	1168x325						
		Island							
		Door Finish							

**GOLA PROFILES - STANDARD**

Base Units		Wall Units		Tall Units	
CODE	LENGTH	CODE	LENGTH	CODE	LENGTH
NGPTOP**	4100	NGPTOPEX**	3900	NGPVS**	2250
Top profile		Top profile external corner		Vertical single profile	
NGPMID**	4100	NGPTOPINT**		NGPVD**	2250
Mid profile		Top profile internal corner		Vertical double profile	
NGPFIXB		NGPMIDEXT**		NGPFIXVS	
Fixing brackets [pack 10]		Mid profile external corner		Vertical SINGLE fixing [each]	
NGPTOPCAP**		NGPMIDINT**		- 4 required per rail	
Top profile end caps [Pr]		Mid profile internal corner		NGPFIXVD	
NGPMIDCAP**		NGPILCON		Vertical DOUBLE fixing [each]	
Mid profile end caps [Pr]		In-line connector		- 4 required per rail	



Standard colours  
 - Matt Black [MB] and Anodised Steel [AS]

**GOLA PROFILES - BESPOKE PAINTED - SOLID COLOURS**

Base Units		Wall Units		Tall Units	
CODE	LENGTH	CODE	LENGTH	CODE	LENGTH
NGPTOP**	3000	NGPTOPEX**	3000	NGPVS**	2250
Top profile		Top profile external corner		Vertical single profile	
NGPMID**	3000	NGPTOPINT**		NGPVD**	2250
Mid profile		Top profile internal corner		Vertical double profile	
NGPFIX10		NGPMIDEXT**		NGPFIXVS	
Fixing brackets [pack 10]		Mid profile external corner		Vertical SINGLE fixing [each]	
NGPTOPCAP**		NGPMIDINT**		- 4 required per rail	
Top profile end caps [Pr]		Mid profile internal corner		NGPFIXVD	
NGPMIDCAP**		NGPILCON		Vertical DOUBLE fixing [each]	
Mid profile end caps [Pr]		In-line connector		- 4 required per rail	



Bespoke solid colours  
 - Dark Blue [DB], Grey Blue [GB], Graphite [GR], Leaf [LF], Light Grey [LG], Luna [LU], Peacock [PC] and Stone Blue [SB]

**GOLA PROFILES - BESPOKE PAINTED - SHIMMERING COLOURS**

Base Units		Wall Units		Tall Units	
CODE	LENGTH	CODE	LENGTH	CODE	LENGTH
NGPTOP**	3000	NGPTOPEX**	3000	NGPVS**	2250
Top profile		Top profile external corner		Vertical single profile	
NGPMID**	3000	NGPTOPINT**		NGPVD**	2250
Mid profile		Top profile internal corner		Vertical double profile	
NGPFIX10		NGPMIDEXT**		NGPFIXVS	
Fixing brackets [pack 10]		Mid profile external corner		Vertical SINGLE fixing [each]	
NGPTOPCAP**		NGPMIDINT**		- 4 required per rail	
Top profile end caps [Pr]		Mid profile internal corner		NGPFIXVD	
NGPMIDCAP**		NGPILCON		Vertical DOUBLE fixing [each]	
Mid profile end caps [Pr]		In-line connector		- 4 required per rail	



Bespoke Shimmering Colours  
 - Gold Dust [GD] and Rose Gold [RG]

- When installing an integrated under counter appliance, please check the appliance height carefully to establish if it will fit below the top profile [812mm high or less]. The plinth height can be raised slightly to accommodate taller appliances.
- If using free-standing appliances, end panels must be fitted either side of the appliance and the rail profile finishes against the panel, and end caps fitted if required.
- A top rail profile cannot be used with a built-under single oven in the Verse range. The rails must stop on each side of the appliance and end caps fitted.
- When using an 'L' shaped corner wall unit, the Verse wall rail will need to be mitred on site.
- When planning ensure a 30mm gap is left between, or to the side of all Midi & Tall housings for the vertical profile to be fitted.
- When ordering Midi and Tall units, ensure that you specify either LHH [left hand hinge], RHH [right hand hinge] or Double [units with vertical profiles on both sides] to ensure that the unit ordered is supplied with the correct gables.
- When using either a sink or hob, the distance behind the top rail profile to the back of the carcass is 534mm, therefore units may need to be pulled forward from the wall to accommodate your products. See our Verse Technical Guide for further details on this range. Alternatively, you can call our Furniture team for product information.



Scan here to view our Verse Technical Guide.

VERSE

PRICE GROUP 3

ENKO

Special sizes available  
contact us for further information

Colours Options [PG3]: Black, Fern, Hunter, Indigo, Stone and Taupe.



HI-LINE BASE HI-LINE CORNER BASE

Pull-Out				Shallow Base [300mm deep]				'L' Shaped			
H:720mm CODE	WIDTH	CODE	WIDTH	H:720mm CODE	WIDTH	H:720mm CODE	WIDTH	H:720mm CODE	WIDTH	H:720mm CODE	WIDTH
RVBA15	150	RVBA60	600	RVBISPO15	150	RVBSU30	300	RVBSU70	700	RVBAC830	800/300
RVBA26	260	RVBA70	700	Standard Mechanism inc.		RVBSU35	350	RVBSU80	800	RVBAC80	800/400
RVBA30	300	RVBA80	800	RVBKPO15	150	RVBSU40	400	RVBSU90	900	RVBAC845	800/450
RVBA35	350	RVBA90	900	Kesseböhmer Mechanism inc.		RVBSU45	450	RVBSU10	1000	RVBAC850	800/500
RVBA40	400	RVBA10	1000	RVBKTP015	150	RVBSU50	500			RVBAC860	800/600
RVBA45	450	RVBA12	1200	Kesseböhmer Mechanism & Towel rail inc.		RVBSU60	600			RVBAC890	900/400
RVBA50	500									RVBAC945	900/450

BUILT UNDER OVEN 2 DRAWER BASE 3 DRAWER BASE LOW WALL MEDIUM WALL

BUILT UNDER OVEN			2 DRAWER BASE			3 DRAWER BASE			LOW WALL			MEDIUM WALL		
H:720mm CODE	WIDTH	CODE	H:720mm CODE	WIDTH	CODE	H:720mm CODE	WIDTH	CODE	H:720mm CODE	WIDTH	H:720mm CODE	WIDTH		
RBV060*	600	RVBD230	RVBD240	RVBD250	RVBD260	RVBD280	RVBD290	RVBD210	RVBD330	RVBD340	RVBD350	RVBD360		
*Non-verse spec.		300	400	500	600	800	900	1000	300	400	500	600		

MEDIUM WALL TALL WALL HORIZONTAL WALL

'L' Shaped Corner				Bi-Fold				Boiler			
H:720mm CODE	D:300mm WIDTH	H:720mm CODE	D:300mm WIDTH	H:900mm CODE	D:300mm WIDTH	H:900mm CODE	D:300mm WIDTH				
RVWU060-7	600x600	RVBFWU50-7	500	RVWU30-9	300	RVWU80-9	800				
Add 'X' to the end of the code for 350mm deep [650x650]		RVBFWU60-7	600	RVWU40-9	400	RVWU90-9	900				
Bi-Fold Hinge System		RVBFWU80-7	800	RVWU45-9	450	RVWU10-9	1000				
		RVBFWU90-7	900	RVWU50-9	500						
		RVBFWU10-7	1000	RVWU60-9	600						

MIDI UNITS LARDER PULL-OUT LARDER INNER DRAWER LARDER

MIDI UNITS		LARDER		PULL-OUT LARDER		INNER DRAWER LARDER	
H:1250mm CODE	WIDTH	H:1970mm CODE	WIDTH	H:1970mm CODE	WIDTH	H:1970mm CODE	WIDTH
RVRMLU60	600	RVTLU30	300	RVTLU30	300	RVTLID30	300
RVMA160	600	RVTLU40	400	RVTLU40	400	RVTLID40	400
RVMD060	600	RVTLU50	500	RVTLU50	500	RVTLID50	500
RVMOHS60	600	RVTLU60	600	RVTLU60	600	RVTLID60	600

DOUBLE OVEN SINGLE OVEN SINGLE OVEN + COMPACT COMPACT FRIDGE + FRIDGE/FREEZER

DOUBLE OVEN		SINGLE OVEN		SINGLE OVEN + COMPACT		COMPACT		FRIDGE + FRIDGE/FREEZER	
H:1970mm CODE	WIDTH	H:1970mm CODE	WIDTH	H:1970mm CODE	WIDTH	H:1970mm CODE	WIDTH	H:1970mm CODE	WIDTH
RVTOHD60	600	RVTOHS60	600	RVTOHSC60	600	RVTOHC60	600	RVTF1/60	600
RVTOHDD60	600	RVTOHSD60	600	RVTOHSC60*	600	RVTOHC60*	600	RVTF4/60*	600
RVTOHDD60*	600	RVTOHSD60*	600					RVTF11U/60*	600

Note: Furniture codes beginning with the letter 'R' are assembled (rigid), by removing the 'R' the units are supplied unassembled (flat-pack).

END SUPPORT PANELS CARCASE MFC PANELS COMBI PLINTH PLANT ON END PANELS

END SUPPORT PANELS		CARCASE MFC PANELS		COMBI		PLINTH		PLANT ON END PANELS	
H:900mm CODE	WIDTH	CODE	WXH	CODE	WXH	H:36mm CODE	WXD	H:150mm CODE	WIDTH
ESP	600	1970/300	300x1970	UG/**ET	1000x22	UPCM/PM	2740x55	PL	2940
900/700	700	2150/560	560x2150	Un-Glued 1m Carcase Edging		Can also be used as a 36mm wide end post - rebated for plant-on end panels		Melamine [Carcase MFC]	
MFC Carcase		2350/660	660x2350	10ET/PM	Un-glued Edging Tape 10mtr Door Finish	Door Finish		PL/PM	2740
		720/300	300x720					Door Finish	
		900/2000	2000x900						
		900/300	300x900						

PLANT ON END PANELS FURNITURE ACCESSORIES INTEGRATED DOORS SPARE DOOR FITTINGS GENERAL ACCESSORIES

PLANT ON END PANELS		FURNITURE ACCESSORIES		INTEGRATED DOORS		SPARE DOOR FITTINGS		GENERAL ACCESSORIES	
18mm Breakfast Bar Panel	46mm Mitred End Panel	Corner Post [Spare]	Undrilled	Hinges [Hettich Soft Close]	Stays [Blum Aventos]				
900/1200/18PM	1200x900	MIEP9B/PM	900x325	CPH/PM	146	INT4568	446x684	INT6068	596x684
900/2400/18PM	2400x900	MIEP9A/PM	900x684	Flat panel for on site conversion		INT4571	446x715	INT6071	596x715
Door Finish		MIEP12B/PM	1160x325			INT6045	596x450		
		MIEP12A/PM	1160x684						
		Door Finish							

GOLA PROFILES - STANDARD

Base Units		Wall Units		Tall Units	
CODE	LENGTH	CODE	LENGTH	CODE	LENGTH
NGPTOP**	4100	NGPTOPEXT**	3900	NGPVS**	2250
Top profile		Top profile external corner		Vertical single profile	
NGPMID**	4100	NGPTOPINT**		NGPVD**	2250
Mid profile		Top profile internal corner		Vertical double profile	
NGPFIXB		NGPMIDEXT**		NGPFIXVS	
Fixing brackets [pack 10]		Mid profile external corner		Vertical SINGLE fixing [each]	
NGPTOPCAP**		NGPMIDINT**		- 4 required per rail	
Top profile end caps [Pr]		Mid profile internal corner		NGPFIXVD	
NGPMIDCAP**		NGPILCON		Vertical DOUBLE fixing [each]	
Mid profile end caps [Pr]		In-line connector		- 4 required per rail	

GOLA PROFILES - BESPOKE PAINTED - SOLID COLOURS

Base Units		Wall Units		Tall Units	
CODE	LENGTH	CODE	LENGTH	CODE	LENGTH
NGPTOP**	3000	NGPTOPEXT**	3000	NGPVS**	2250
Top profile		Top profile external corner		Vertical single profile	
NGPMID**	3000	NGPTOPINT**		NGPVD**	2250
Mid profile		Top profile internal corner		Vertical double profile	
NGPFIX10		NGPMIDEXT**		NGPFIXVS	
Fixing brackets [pack 10]		Mid profile external corner		Vertical SINGLE fixing [each]	
NGPTOPCAP**		NGPMIDINT**		- 4 required per rail	
Top profile end caps [Pr]		Mid profile internal corner		NGPFIXVD	
NGPMIDCAP**		NGPILCON		Vertical DOUBLE fixing [each]	
Mid profile end caps [Pr]		In-line connector		- 4 required per rail	

GOLA PROFILES - BESPOKE PAINTED - SHIMMERING COLOURS

Base Units		Wall Units		Tall Units	
CODE	LENGTH	CODE	LENGTH	CODE	LENGTH
NGPTOP**	3000	NGPTOPEXT**	3000	NGPVS**	2250
Top profile		Top profile external corner		Vertical single profile	
NGPMID**	3000	NGPTOPINT**		NGPVD**	2250
Mid profile		Top profile internal corner		Vertical double profile	
NGPFIX10		NGPMIDEXT**		NGPFIXVS	
Fixing brackets [pack 10]		Mid profile external corner		Vertical SINGLE fixing [each]	
NGPTOPCAP**		NGPMIDINT**		- 4 required per rail	
Top profile end caps [Pr]		Mid profile internal corner		NGPFIXVD	
NGPMIDCAP**		NGPILCON		Vertical DOUBLE fixing [each]	
Mid profile end caps [Pr]		In-line connector		- 4 required per rail	

- When installing an integrated under counter appliance, please check the appliance height carefully to establish if it will fit below the top profile [812mm high or less]. The plinth height can be raised slightly to accommodate taller appliances.
- If using free-standing appliances, end panels must be fitted either side of the appliance and the rail profile finishes against the panel, and end caps fitted if required.
- A top rail profile cannot be used with a built-under single oven in the Verse range. The rails must stop on each side of the appliance and end caps fitted.
- When using a 'L' shaped corner wall unit, the Verse wall rail will need to be mitred on site.
- When planning ensure a 30mm gap is left between, or to the side of all Midi & Tall housings for the vertical profile to be fitted.
- When ordering Midi and Tall units, ensure that you specify either LHH [left hand hinge], RHH [right hand hinge] or Double [units with vertical profiles on both sides] to ensure that the unit ordered is supplied with the correct gables.
- When using either a sink or hob, the distance behind the top rail profile to the back of the carcass is 534mm, therefore units may need to be pulled forward from the wall to accommodate your products. See our Verse Technical Guide for further details on this range. Alternatively, you can call our Furniture team for product information.



Scan here to view our Verse Technical Guide.

VERSE

PRICE GROUP 1

# EPOS

Special sizes available  
contact us for further information

Colours Options [PG1]: Slate



## HI-LINE BASE HI-LINE CORNER BASE

**Pull-Out**

H:720mm CODE	WIDTH	CODE	WIDTH
RVBA15	150	RVBA60	600
RVBA26	260	RVBA70	700
RVBA30	300	RVBA80	800
RVBA35	350	RVBA90	900
RVBA40	400	RVBA10	1000
RVBA45	450	RVBA12	1200
RVBA50	500		

**Shallow Base [300mm deep]**

H:720mm CODE	WIDTH	CODE	WIDTH
RVBISPO15	150	RVBSU30	300
RVBISPO15	150	RVBSU35	350
RVBISPO15	150	RVBSU40	400
RVBISPO15	150	RVBSU45	450
RVBISPO15	150	RVBSU50	500
RVBISPO15	150	RVBSU60	600

**'L' Shaped**

H:720mm CODE	WIDTH	CODE	WIDTH
RVBAC830	800/300	RVBAC950	900/500
RVBAC80	800/400	RVBAC960	900/600
RVBAC845	800/450	RVBAC140	1000/400
RVBAC850	800/500	RVBAC145	1000/450
RVBAC860	800/600	RVBAC10	1000/500
RVBAC940	900/400	RVBAC160	1000/600
RVBAC945	900/450	RVBAC12	1200/600

Inc. Corner Post & Blanking Panel

**'L' Shaped**

H:720mm CODE	WIDTH	CODE	WIDTH
VBAC90	900x900		

Bi-fold hinge system Flatpack

## BUILT UNDER OVEN 2 DRAWER BASE 3 DRAWER BASE LOW WALL MEDIUM WALL

**BUILT UNDER OVEN**

H:720mm CODE	WIDTH
RBUE060*	600

\*Non-verse spec.

**2 DRAWER BASE**

H:720mm CODE	WIDTH
RVBD230	300
RVBD240	400
RVBD250	500
RVBD260	600
RVBD280	800
RVBD290	900
RVBD210	1000

2x160mm, 1x325mm Drawers

**3 DRAWER BASE**

H:720mm CODE	WIDTH
RVBD330	300
RVBD340	400
RVBD350	500
RVBD360	600
RVBD380	800
RVBD390	900
RVBD310	1000

2x160mm, 1x325mm Drawers

**LOW WALL**

H:720mm CODE	WIDTH
RVWU30-5	300
RVWU40-5	400
RVWU45-5	450
RVWU50-5	500
RVWU60-5	600

Add 'X' to the end of the code for 350mm deep

**MEDIUM WALL**

H:720mm CODE	WIDTH
RVWU80-5	800
RVWU90-5	900
RVWU10-5	1000

Add 'X' to the end of the code for 350mm deep

## MEDIUM WALL TALL WALL HORIZONTAL WALL

**'L' Shaped Corner**

H:720mm CODE	D:300mm WIDTH
RVWU60-7	600x600

Add 'X' to the end of the code for 350mm deep [650x650]

Bi-Fold Hinge System

**Bi-Fold**

H:720mm CODE	D:300mm WIDTH
RVBFWU50-7	500
RVBFWU60-7	600
RVBFWU80-7	800
RVBFWU90-7	900
RVBFWU10-7	1000

Mechanism inc.

Add 'X' to the end of the code for 350mm deep

**Boiler**

H:900mm CODE	D:300mm WIDTH
RVWU30-9	300
RVWU40-9	400
RVWU45-9	450
RVWU50-9	500
RVWU60-9	600

Add 'X' to the end of the code for 350mm deep

**HORIZONTAL WALL**

H:290mm CODE	D:300mm WIDTH	H:360mm CODE	D:300mm WIDTH
RVHWU5029	500	RVHWU5036	500
RVHWU6029	600	RVHWU6036	600
RVHWU8029	800	RVHWU8036	800
RVHWU9029	900	RVHWU9036	900
RVHWU1029	1000	RVHWU1036	1000

All include Blum Aventos HKS System

Add 'X' to the end of the code for 350mm deep

## MIDI UNITS LARDER PULL-OUT LARDER INNER DRAWER LARDER

**MIDI UNITS**

H:1250mm CODE	WIDTH
RVRMLU60	600
RVMA160	600
RVMD060	600
RVMOH560	600

**LARDER**

H:1970mm CODE	WIDTH
RVTLU30	300
RVTLU40	400
RVTLU50	500
RVTLU60	600

**PULL-OUT LARDER**

H:1970mm CODE	*H:2150mm WIDTH
RVTISPOL30	300
RVTKPOL30	300

Standard Mechanism inc.

RVETISPOL30\* 300

RVETKPOL30\* 300

Kesseböhmer Mechanism inc.

**INNER DRAWER LARDER**

H:1970mm CODE	WIDTH	H:2150mm CODE	WIDTH
RVTLID30	300	RVETLID30	300
RVTLID40	400	RVETLID40	400
RVTLID50	500	RVETLID50	500
RVTLID60	600	RVETLID60	600

1x Standard, 4x Deep Drawers

## DOUBLE OVEN SINGLE OVEN SINGLE OVEN + COMPACT COMPACT FRIDGE + FRIDGE/FREEZER

**DOUBLE OVEN**

H:1970mm CODE	*H:2150mm WIDTH
RVTOHD60	600
RVTOHDD60	600
RVTOHDD60*	600

**SINGLE OVEN**

H:1970mm CODE	*H:2150mm WIDTH
RVTOHS60	600
RVTOHSD60	600
RVTOHS60*	600

**SINGLE OVEN + COMPACT**

H:1970mm CODE	*H:2150mm WIDTH
RVTOHSC60	600
RVTOHSC60*	600

**COMPACT**

H:1970mm CODE	*H:2150mm WIDTH
RVTOHC60	600
RVTOHC60*	600

**FRIDGE + FRIDGE/FREEZER**

H:1970mm CODE	WIDTH	H:2150mm CODE	WIDTH
RVTF160	600	RVTF1F160	600
RVTF460*	600	RVTF2F160	600
RVTF460*	600	RVTF1U/60*	600
RVTF460*	600	RVTF2U/60*	600

\*Doors undrilled

\*For door on door appliances

\*For door on door appliances

Note: Furniture codes beginning with the letter 'R' are assembled (rigid), by removing the 'R' the units are supplied unassembled (flat-pack).

## END SUPPORT PANELS CARCASE MFC PANELS PLINTH PLANT ON END PANELS

**END SUPPORT PANELS**

H:900mm CODE	WIDTH	CODE	WXH
ESP	600	1970/300	300x1970
900/700	700	2150/560	560x2150
		2350/660	660x2350
		720/300	300x720
		900/2000	2000x900
		900/300	300x900

MFC Carcase

**CARCASE MFC PANELS**

CODE	WXH
UG/**ET	1000x22

Un-Glued 1m Carcase Edging

**PLINTH**

H:150mm CODE	WIDTH	CODE	WIDTH
PL	2940	PST	3000

Melamine [Carcase MFC]

Door Finish

**PLANT ON END PANELS**

CODE	WXH
2400/650/18PSL	650x2400
900/350/18PSL	350x900
900/650/18PSL	650x900

Door Finish

## PLANT ON END PANELS FURNITURE ACCESSORIES INTEGRATED DOORS SPARE DOOR FITTINGS GENERAL ACCESSORIES

**PLANT ON END PANELS**

CODE	WXH
900/1200/18PSL	1200x900

Door Finish

**FURNITURE ACCESSORIES**

CODE	WXH	CODE	WIDTH
MIEP9B/PSL	900x325	CPH/PSL	146
MIEP9A/PSL	900x684		
MIEP12B/PSL	1160x325		
MIEP12A/PSL	1160x684		

Door Finish

**INTEGRATED DOORS**

CODE	WXH	CODE	WXH
INT4568	446x684	INT6068	596x684
INT4571	446x715	INT6071	596x715
INT6045	596x450		

Undrilled

**SPARE DOOR FITTINGS**

CODE	DESCRIPTION
SCHINGE90	90 degree [Pair]
SCHINGE170	170 degree [Pair]

Hinges [Hettich Soft Close]

**GENERAL ACCESSORIES**

CODE	DESCRIPTION
STPWN	Set of 2 Door strapping plates
LEGSET	Set of 4 Adjustable legs

**Stays [Blum Aventos]**

CODE	DESCRIPTION
BLSTAYHKS	HK-S stay [Pair]

\*[inc mounting brackets]

## GOLA PROFILES - STANDARD

**Base Units**

CODE	LENGTH
NGPTOP**	4100
NGPMID**	4100
NGPFIXB	
NGPTOPCAP**	
NGPMIDCAP**	

**Wall Units**

CODE	LENGTH
NGPWALL**	3900

**Tall Units**

CODE	LENGTH
NGPV**	2250
NGPVD**	2250
NGPFIXVS	
NGPFIXVD	

**Standard colours**

- Matt Black [MB] and Anodised Steel [AS]

## GOLA PROFILES - BESPOKE PAINTED - SOLID COLOURS

**Base Units**

CODE	LENGTH
NGPTOP**	3000
NGPMID**	3000
NGPFIX10	
NGPTOPCAP**	
NGPMIDCAP**	

**Wall Units**

CODE	LENGTH
NGPWALL**	3000

**Tall Units**

CODE	LENGTH
NGPV**	2250
NGPVD**	2250
NGPFIXVS	
NGPFIXVD	

**Bespoke solid colours**

- Dark Blue [DB], Grey Blue [GB], Graphite [GR], Leaf [LF], Light Grey [LG], Luna [LU], Peacock [PC] and Stone Blue [SB]

## GOLA PROFILES - BESPOKE PAINTED - SHIMMERING COLOURS

**Base Units**

CODE	LENGTH
NGPTOP**	3000
NGPMID**	3000
NGPFIX10	
NGPTOPCAP**	
NGPMIDCAP**	

**Wall Units**

CODE	LENGTH
NGPWALL**	3000

**Tall Units**

CODE	LENGTH
NGPV**	2250
NGPVD**	2250
NGPFIXVS	
NGPFIXVD	

**Bespoke Shimmering Colours**

- Gold Dust [GD] and Rose Gold [RG]

- When installing an integrated under counter appliance, please check the appliance height carefully to establish if it will fit below the top profile [812mm high or less]. The plinth height can be raised slightly to accommodate taller appliances.
- If using free-standing appliances, end panels must be fitted either side of the appliance and the rail profile finishes against the panel, and end caps fitted if required.
- A top rail profile cannot be used with a built-under single oven in the Verse range. The rails must stop on each side of the appliance and end caps fitted.
- When using a 'L' shaped corner wall unit, the Verse wall rail will need to be mitred on site.
- When planning ensure a 30mm gap is left between, or to the side of all Midi & Tall housings for the vertical profile to be fitted.
- When ordering Midi and Tall units, ensure that you specify either LHH [left hand hinge], RHH [right hand hinge] or Double [units with vertical profiles on both sides] to ensure that the unit ordered is supplied with the correct gables.
- When using either a sink or hob, the distance behind the top rail profile to the back of the carcass is 534mm, therefore units may need to be pulled forward from the wall to accommodate your products. See our Verse Technical Guide for further details on this range. Alternatively, you can call our Furniture team for product information.



Scan here to view our Verse Technical Guide.

VERSE  
PRICE GROUP 3  
**JUKO MATT**

Special sizes available  
contact us for further information

Colours Options [PG3]: Ash, Cloud and Graphite.



HI-LINE BASE HI-LINE CORNER BASE

Pull-Out				Shallow Base [300mm deep]				'L' Shaped			
H:720mm CODE	WIDTH	CODE	WIDTH	H:720mm CODE	WIDTH	H:720mm CODE	WIDTH	H:720mm CODE	WIDTH	H:720mm CODE	WIDTH
RVBA15	150	RVBA70	700	RVBISPO15	150	RVSBU30	300	RVSBU70	700	RVBAC830	800/300
RVBA30	300	RVBA80	800	RVBKPO15	150	RVSBU35	350	RVSBU80	800	RVBAC840	800/400
RVBA35	350	RVBA90	900			RVSBU40	400	RVSBU90	900	RVBAC845	800/450
RVBA40	400	RVBA10	1000			RVSBU45	450	RVSBU10	1000	RVBAC850	800/500
RVBA45	450	RVBA12	1200			RVSBU50	500			RVBAC860	800/600
RVBA50	500					RVSBU60	600			RVBAC890	900/400
RVBA60	600									RVBAC945	900/450

RVBISPO15 Standard Mechanism inc.  
RVBKPO15 Kesseböhmer Mechanism inc.  
RVBKTPO15 Kesseböhmer Mechanism & Towel rail inc.

RVBAC90 Bi-fold hinge system Flatpack  
RVBAC12 In-c. Corner Post & Blanking Panel

BUILT UNDER OVEN 2 DRAWER BASE 3 DRAWER BASE LOW WALL MEDIUM WALL

BUILT UNDER OVEN		2 DRAWER BASE		3 DRAWER BASE		LOW WALL		MEDIUM WALL	
H:720mm CODE	WIDTH	H:720mm CODE	WIDTH	H:720mm CODE	WIDTH	H:720mm CODE	WIDTH	H:720mm CODE	WIDTH
RBUE060*	600	RVBD250	500	RVBD350	500	RVWU30-5	300	RVWU80-5	800
		RVBD260	600	RVBD360	600	RVWU40-5	400	RVWU90-5	900
		RVBD280	800	RVBD380	800	RVWU45-5	450	RVWU10-5	1000
		RVBD290	900	RVBD390	900	RVWU50-5	500		
		RVBD210	1000	RVBD310	1000	RVWU60-5	600		

\*Non-verse spec.  
2x325mm Drawers  
2x160mm, 1x325mm Drawers

Add 'X' to the end of the code for 350mm deep  
Add 'X' to the end of the code for 350mm deep

MEDIUM WALL TALL WALL HORIZONTAL WALL

'L' Shaped Corner		Bi-Fold		Boiler	
H:720mm CODE	D:300mm WIDTH	H:720mm CODE	D:300mm WIDTH	H:900mm CODE	D:300mm WIDTH
RVWL60-7	600x600	RVBFWU50-7	500	RVWU30-9	300
		RVBFWU60-7	600	RVWU40-9	400
		RVBFWU80-7	800	RVWU45-9	450
		RVBFWU90-7	900	RVWU50-9	500
		RVBFWU10-7	1000	RVWU60-9	600

Add 'X' to the end of the code for 350mm deep  
Add 'X' to the end of the code for 350mm deep

MIDI UNITS LARDER PULL-OUT LARDER INNER DRAWER LARDER

MIDI UNITS		LARDER		PULL-OUT LARDER		INNER DRAWER LARDER	
H:1250mm CODE	WIDTH	H:1970mm CODE	WIDTH	H:1970mm CODE	*H:2150mm WIDTH	H:1970mm CODE	H:2150mm WIDTH
RVRLU60	600	RVTLU30	300	RVTLUSD50	500	RVTLID30	300
RVMA160	600	RVTLU40	400	RVTLUSD60	600	RVTLID40	400
RVMD060	600	RVTLU50	500			RVTLID50	500
RVMOHS60	600	RVTLU60	600			RVTLID60	600

RVTLUSD50 Standard Mechanism inc.  
RVTLUSD60 Kesseböhmer Mechanism inc.

RVTLID30 1x Standard, 4x Deep Drawers

DOUBLE OVEN SINGLE OVEN SINGLE OVEN + COMPACT COMPACT FRIDGE + FRIDGE/FREEZER

DOUBLE OVEN		SINGLE OVEN		SINGLE OVEN + COMPACT		COMPACT		FRIDGE + FRIDGE/FREEZER	
H:1970mm CODE	*H:2150mm WIDTH	H:1970mm CODE	*H:2150mm WIDTH	H:1970mm CODE	*H:2150mm WIDTH	H:1970mm CODE	*H:2150mm WIDTH	H:1970mm CODE	H:2150mm WIDTH
RVTOHD60	600	RVTOHS60	600	RVTOHSC60	600	RVTOHC60	600	RVTF1/60	600
RVTOHD60	600	RVTOHS60	600	RVTOHSC60*	600	RVTOHC60*	600	RVTF4/60*	600
RVTOHD60*	600	RVTOHS60*	600					RVTF11U/60*	600
								RVTF4U/60*	600

\*Doors undrilled  
\*For door on door appliances  
\*For door on door appliances

Note: Furniture codes beginning with the letter 'R' are assembled (rigid), by removing the 'R' the units are supplied unassembled (flat-pack).

END SUPPORT PANELS		CARCASE MFC PANELS		COMBI		PLINTH		PLANT ON END PANELS	
H:900mm CODE	WIDTH	CODE	WXH	CODE	WXH	H:25mm CODE	WIDTH	H:150mm CODE	WIDTH
ESP	600	1970/300	300x1970	UG/**ET	1000x22	PCM/BM	3000	PL	2940
900/700	700	2150/560	560x2150		Un-Glued 1m Carcase Edging		Door Finish	PST	3000
		2350/660	660x2350						
		720/300	300x720						
		900/2000	2000x900						
		900/300	300x900						

MFC Carcase

PLANT ON END PANELS		FURNITURE ACCESSORIES		INTEGRATED DOORS		SPARE DOOR FITTINGS		GENERAL ACCESSORIES	
CODE	WXH	CODE	WXH	CODE	WXH	CODE	WXH	CODE	WXH
910/1185/22BM	1185x910	MBEPA/BM	604x684	CPHT/BM	60	INT4568	446x684	SCHINGE90	90 degree [Pair]
900/2400/22BM	2400x900	MIEP9A/BM	908x684		Flat panel for on site conversion	INT4571	446x715	SCHINGE170	170 degree [Pair]
		MIEP12A/BM	1168x684			INT6045	596x450		

Door Finish

GOLA PROFILES - STANDARD					
Base Units		Wall Units		Tall Units	
CODE	LENGTH	CODE	LENGTH	CODE	LENGTH
NGPTOP**	4100	NGPTOPEX**	3900	NGPVS**	2250
RVWU26-7	260	Top profile external corner		NGPFXV**	2250
RVWU30-7	300	NGPTOPINT**		NGPVD**	2250
RVWU35-7	350	Top profile internal corner		NGPFXVS	580mm
RVWU40-7	400	NGPMIDEXT**		Vertical SINGLE fixing [each]	
RVWU45-7	450	Mid profile external corner		- 4 required per rail	
RVWU50-7	500	NGPMIDINT**		NGPFXVD	580mm
		Mid profile internal corner		Vertical DOUBLE fixing [each]	
		NGPILCON		- 4 required per rail	
		In-line connector			



Standard colours  
- Matt Black [MB] and Anodised Steel [AS]

GOLA PROFILES - BESPOKE PAINTED - SOLID COLOURS					
Base Units		Wall Units		Tall Units	
CODE	LENGTH	CODE	LENGTH	CODE	LENGTH
NGPTOP**	3000	NGPTOPEX**	3000	NGPVS**	2250
RVWU5029	500	Top profile external corner		NGPFXV**	2250
RVWU6029	600	NGPTOPINT**		NGPVD**	2250
RVWU8029	800	Top profile internal corner		NGPFXVS	580mm
RVWU9029	900	NGPMIDEXT**		Vertical SINGLE fixing [each]	
RVWU1029	1000	Mid profile external corner		- 4 required per rail	
		NGPMIDINT**		NGPFXVD	580mm
		Mid profile internal corner		Vertical DOUBLE fixing [each]	
		NGPILCON		- 4 required per rail	
		In-line connector			



Bespoke solid colours  
- Dark Blue [DB], Grey Blue [GB], Graphite [GR], Leaf [LF], Light Grey [LG], Luna [LU], Peacock [PC] and Stone Blue [SB]

GOLA PROFILES - BESPOKE PAINTED - SHIMMERING COLOURS					
Base Units		Wall Units		Tall Units	
CODE	LENGTH	CODE	LENGTH	CODE	LENGTH
NGPTOP**	3000	NGPTOPEX**	3000	NGPVS**	2250
RVWU5029	500	Top profile external corner		NGPFXV**	2250
RVWU6029	600	NGPTOPINT**		NGPVD**	2250
RVWU8029	800	Top profile internal corner		NGPFXVS	580mm
RVWU9029	900	NGPMIDEXT**		Vertical SINGLE fixing [each]	
RVWU1029	1000	Mid profile external corner		- 4 required per rail	
		NGPMIDINT**		NGPFXVD	580mm
		Mid profile internal corner		Vertical DOUBLE fixing [each]	
		NGPILCON		- 4 required per rail	
		In-line connector			



Bespoke Shimmering Colours  
- Gold Dust [GD] and Rose Gold [RG]

- When installing an integrated under counter appliance, please check the appliance height carefully to establish if it will fit below the top profile [812mm high or less]. The plinth height can be raised slightly to accommodate taller appliances.
- If using free-standing appliances, end panels must be fitted either side of the appliance and the rail profile finishes against the panel, and end caps fitted if required.
- A top rail profile cannot be used with a built-under single oven in the Verse range. The rails must stop on each side of the appliance and end caps fitted.
- When using a 'L' shaped corner wall unit, the Verse wall rail will need to be mitred on site.
- When planning ensure a 30mm gap is left between, or to the side of all Midi & Tall housings for the vertical profile to be fitted.
- When ordering Midi and Tall units, ensure that you specify either LHH [left hand hinge], RHH [right hand hinge] or Double [units with vertical profiles on both sides] to ensure that the unit ordered is supplied with the correct gables.
- When using either a sink or hob, the distance behind the top rail profile to the back of the carcass is 534mm, therefore units may need to be pulled forward from the wall to accommodate your products. See our Verse Technical Guide for further details on this range. Alternatively, you can call our Furniture team for product information.



Scan here to view our Verse Technical Guide.

Note: Furniture codes beginning with the letter 'R' are assembled (rigid), by removing the 'R' the units are supplied unassembled (flat-pack).

VERSE

PRICE GROUP 2  
**KOLT**

Special sizes available  
contact us for further information

Colours Options [PG2]- Ash Marble, Copper Blend, Dark Oak, Graphite Blend, Grey Blend, Grey Marble, Lead Marble, Natural Oak, and White Oak.



HI-LINE BASE HI-LINE CORNER BASE

**Pull-Out** **Shallow Base [300mm deep]** **'L' Shaped**

H:720mm CODE	WIDTH	CODE	WIDTH	H:720mm CODE	WIDTH	H:720mm CODE	WIDTH	H:720mm CODE	WIDTH	H:720mm CODE	WIDTH
RVBA15	150	RVBA60	600	RVBISPO15	150	RVSBU30	300	RVSBU70	700	RVBAC830	800/300
RVBA26	260	RVBA70	700	RVBISPO15	150	RVSBU35	350	RVSBU80	800	RVBAC840	800/400
RVBA30	300	RVBA80	800	RVBISPO15	150	RVSBU40	400	RVSBU90	900	RVBAC845	800/450
RVBA35	350	RVBA90	900	RVBISPO15	150	RVSBU45	450	RVSBU100	1000	RVBAC850	800/500
RVBA40	400	RVBA10	1000	RVBISPO15	150	RVSBU50	500			RVBAC860	800/600
RVBA45	450	RVBA12	1200	RVBISPO15	150	RVSBU60	600			RVBAC880	800/800
RVBA50	500			RVBISPO15	150					RVBAC900	900/400
				RVBISPO15	150					RVBAC945	900/450

Standard Mechanism inc. Kesseböhmer Mechanism inc. Kesseböhmer Mechanism & Towel rail inc. Inc. Corner Post & Blanking Panel

BUILT UNDER OVEN 2 DRAWER BASE 3 DRAWER BASE LOW WALL MEDIUM WALL

**BUILT UNDER OVEN** **2 DRAWER BASE** **3 DRAWER BASE** **LOW WALL** **MEDIUM WALL**

H:720mm CODE	WIDTH	H:720mm CODE	WIDTH	H:720mm CODE	WIDTH	H:575mm CODE	WIDTH	D:300mm H:720mm CODE	WIDTH	D:300mm H:720mm CODE	WIDTH
RBUD060*	600	RVBD230	300	RVBD330	300	RVWU30-5	300	RVWU80-5	800	RVWU26-7	260
		RVBD240	400	RVBD340	400	RVWU40-5	400	RVWU90-5	900	RVWU30-7	300
		RVBD250	500	RVBD350	500	RVWU45-5	450	RVWU10-5	1000	RVWU35-7	350
		RVBD260	600	RVBD360	600	RVWU50-5	500			RVWU40-7	400
		RVBD280	800	RVBD380	800	RVWU60-5	600			RVWU45-7	450
		RVBD290	900	RVBD390	900					RVWU50-7	500
		RVBD310	1000	RVBD310	1000						

\*Non-verse spec. 2x325mm Drawers 2x160mm, 1x325mm Drawers Add 'X' to the end of the code for 350mm deep

MEDIUM WALL TALL WALL HORIZONTAL WALL

**'L' Shaped Corner** **Bi-Fold** **Boiler**

H:720mm CODE	D:300mm WIDTH	H:720mm CODE	D:300mm WIDTH	H:900mm CODE	D:300mm WIDTH	H:900mm CODE	D:300mm WIDTH	H:290mm CODE	D:300mm WIDTH	H:360mm CODE	D:300mm WIDTH
RVCWL60-7	600x600	RVBFWU50-7	500	RVWU30-9	300	RVWU80-9	800	RVHWU5029	500	RVHWU5036	500
		RVBFWU60-7	600	RVWU40-9	400	RVWU90-9	900	RVHWU6029	600	RVHWU6036	600
		RVBFWU80-7	800	RVWU45-9	450	RVWU10-9	1000	RVHWU8029	800	RVHWU8036	800
		RVBFWU90-7	900	RVWU50-9	500			RVHWU9029	900	RVHWU9036	900
		RVBFWU10-7	1000	RVWU60-9	600			RVHWU1029	1000	RVHWU1036	1000

Bi-Fold Hinge System Mechanism inc. Add 'X' to the end of the code for 350mm deep. All include Blum Aventos HKS System. Add 'X' to the end of the code for 350mm deep

MIDI UNITS LARDER PULL-OUT LARDER INNER DRAWER LARDER

**MIDI UNITS** **LARDER** **PULL-OUT LARDER** **INNER DRAWER LARDER**

H:1250mm CODE	WIDTH	H:1970mm CODE	WIDTH	H:1970mm CODE	WIDTH	H:2150mm CODE	WIDTH	H:1970mm CODE	WIDTH	H:2150mm CODE	WIDTH
RVRMLU60	600	RVTLU30	300	RVTLUSD50	500	RVETLU30	300	RVTID30	300	RVETLID30	300
RVMA160	600	RVTLU40	400	RVTLUSD60	600	RVETLU40	400	RVTID40	400	RVETLID40	400
RVMD060	600	RVTLU50	500			RVETLU50	500	RVTID50	500	RVETLID50	500
RVMOH560	600	RVTLU60	600			RVETLU60	600	RVTID60	600	RVETLID60	600

Standard Mechanism inc. Kesseböhmer Mechanism inc. 1x Standard, 4x Deep Drawers

DOUBLE OVEN SINGLE OVEN SINGLE OVEN + COMPACT COMPACT FRIDGE + FRIDGE/FREEZER

**DOUBLE OVEN** **SINGLE OVEN** **SINGLE OVEN + COMPACT** **COMPACT** **FRIDGE + FRIDGE/FREEZER**

H:1970mm CODE	WIDTH	*H:2150mm CODE	WIDTH	H:1970mm CODE	WIDTH	*H:2150mm CODE	WIDTH	H:1970mm CODE	WIDTH	*H:2150mm CODE	WIDTH
RVTOHD60	600	RVTOHS60	600	RVTOHSC60	600	RVTOHC60	600	RVTF1/60	600	RVTF2/60	600
RVTOHDD60	600	RVTOHSD60	600	RVTOHSC60*	600	RVTOHC60*	600	RVTF3/60*	600	RVTF4/60*	600
RVTOHDD60*	600	RVTOHSD60*	600					RVTF5/60*	600	RVTF6/60*	600

\*Doors undrilled \*For door on door appliances \*For door on door appliances \*15mm bottom, 1425mm top door

Note: Furniture codes beginning with the letter 'R' are assembled (rigid), by removing the 'R' the units are supplied unassembled (flat-pack).

END SUPPORT PANELS CARCASE MFC PANELS COMBI PLINTH PLANT ON END PANELS

**END SUPPORT PANELS** **CARCASE MFC PANELS** **COMBI** **PLINTH** **PLANT ON END PANELS**

H:900mm CODE	WIDTH	CODE	WXH	CODE	WXH	H:18mm CODE	WXD	H:150mm CODE	WIDTH	CODE	WIDTH	CODE	WXH
ESP	600	1970/300	300x1970	UG/**ET	1000x22	CM/MK	2700x70	PL	2940	PST	3000	2400/650/18MK	650x2400
900/700	700	2150/560	560x2150	Un-Glued 1m Carcase Edging	1000	Door Finish		Melamine [Carcase MFC]				940/375/18MK	375x940
MFC Carcase		2350/660	660x2350	Un-Glued edging tape Per Mtr	1000x22			PL/MK	2700			900/650/18MK	650x900
		720/300	300x720	Door Finish				Door Finish					
		900/2000	2000x900										
		900/300	300x900										

PLANT ON END PANELS FURNITURE ACCESSORIES INTEGRATED DOORS SPARE DOOR FITTINGS GENERAL ACCESSORIES

**PLANT ON END PANELS** **FURNITURE ACCESSORIES** **INTEGRATED DOORS** **SPARE DOOR FITTINGS** **GENERAL ACCESSORIES**

18mm Breakfast Bar Panel	Corner Post [Spare]	External Corner Post	Undrilled	Hinges [Hettich Soft Close]	Stays [Blum Aventos]
900/1200/18MK	CPH/MK	ECPH/MK	INT4568	SCHINGE90	BLSTAYHKS
1200x900	146	60	446x684	90 degree [Pair]	HK-S stay [Pair]
Door Finish	Flat panel for on site conversion	Two parts for on site conversion	596x715	170 degree [Pair]	[inc mounting brackets]

GOLA PROFILES - STANDARD

**GOLA PROFILES - STANDARD**

Base Units	Wall Units	Tall Units
NGPTOP** 4100	NGPWALL** 3900	NGPVS** 2250
Top profile	Top profile external corner	Vertical single profile
NGPMID** 4100	NGPTOPINT**	NGPVD** 2250
Mid profile	Top profile internal corner	Vertical double profile
NGPFIXB	NGPMIDEXT**	NGPFIXVS
Fixing brackets [pack 10]	Mid profile external corner	Vertical SINGLE fixing [each]
NGPTOPCAP**	NGPMIDINT**	- 4 required per rail
Top profile end caps [Pr]	Mid profile internal corner	NGPFIXVD
NGPMIDCAP**	NGPILCON	Vertical DOUBLE fixing [each]
Mid profile end caps [Pr]	In-line connector	- 4 required per rail

Standard colours - Matt Black [MB] and Anodised Steel [AS]

GOLA PROFILES - BESPOKE PAINTED - SOLID COLOURS

**GOLA PROFILES - BESPOKE PAINTED - SOLID COLOURS**

Base Units	Wall Units	Tall Units
NGPTOP** 3000	NGPWALL** 3000	NGPVS** 2250
Top profile	Top profile external corner	Vertical single profile
NGPMID** 3000	NGPTOPINT**	NGPVD** 2250
Mid profile	Top profile internal corner	Vertical double profile
NGPFIX10	NGPMIDEXT**	NGPFIXVS
Fixing brackets [pack 10]	Mid profile external corner	Vertical SINGLE fixing [each]
NGPTOPCAP**	NGPMIDINT**	- 4 required per rail
Top profile end caps [Pr]	Mid profile internal corner	NGPFIXVD
NGPMIDCAP**	NGPILCON	Vertical DOUBLE fixing [each]
Mid profile end caps [Pr]	In-line connector	- 4 required per rail

Bespoke solid colours - Dark Blue [DB], Grey Blue [GB], Graphite [GR], Leaf [LF], Light Grey [LG], Luna [LU], Peacock [PC] and Stone Blue [SB]

GOLA PROFILES - BESPOKE PAINTED - SHIMMERING COLOURS

**GOLA PROFILES - BESPOKE PAINTED - SHIMMERING COLOURS**

Base Units	Wall Units	Tall Units
NGPTOP** 3000	NGPWALL** 3000	NGPVS** 2250
Top profile	Top profile external corner	Vertical single profile
NGPMID** 3000	NGPTOPINT**	NGPVD** 2250
Mid profile	Top profile internal corner	Vertical double profile
NGPFIX10	NGPMIDEXT**	NGPFIXVS
Fixing brackets [pack 10]	Mid profile external corner	Vertical SINGLE fixing [each]
NGPTOPCAP**	NGPMIDINT**	- 4 required per rail
Top profile end caps [Pr]	Mid profile internal corner	NGPFIXVD
NGPMIDCAP**	NGPILCON	Vertical DOUBLE fixing [each]
Mid profile end caps [Pr]	In-line connector	- 4 required per rail

Bespoke Shimmering Colours - Gold Dust [GD] and Rose Gold [RG]

- When installing an integrated under counter appliance, please check the appliance height carefully to establish if it will fit below the top profile (812mm high or less). The plinth height can be raised slightly to accommodate taller appliances.
- If using free-standing appliances, end panels must be fitted either side of the appliance and the rail profile finishes against the panel, and end caps fitted if required.
- A top rail profile cannot be used with a built-under single oven in the Verse range. The rails must stop on each side of the appliance and end caps fitted.
- When using an 'L' shaped corner wall unit, the Verse wall rail will need to be mitred on site.
- When planning ensure a 30mm gap is left between, or to the side of all Midi & Tall housings for the vertical profile to be fitted.
- When ordering Midi and Tall units, ensure that you specify either LHH (left hand hinge), RHH (right hand hinge) or Double [units with vertical profiles on both sides] to ensure that the unit ordered is supplied with the correct gables.
- When using either a sink or hob, the distance behind the top rail profile to the back of the carcass is 534mm, therefore units may need to be pulled forward from the wall to accommodate your products. See our Verse Technical Guide for further details on this range. Alternatively, you can call our Furniture team for product information.

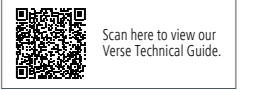

Scan here to view our Verse Technical Guide.



VERSE  
PRICE GROUP 6+7  
**LANGLEY**  
PAINT TO ORDER

Special sizes available  
contact us for further information

Colours Options [PG6]: Auburn, Black, Bone, Cashmere, Coal, Cotton, Dusty Rose, Fern, Forest, Mink, Mist, Moss, Navy, Putty, Riptide, Sea Salt, Smoke, Space, Thyme and Twilight.

Bespoke Colour Option [PG7].



HI-LINE BASE

Pull-Out				Shallow Base [300mm deep]				L' Shaped			
H:720mm CODE	WIDTH	CODE	WIDTH	H:720mm CODE	WIDTH	H:720mm CODE	WIDTH	H:720mm CODE	WIDTH	H:720mm CODE	WIDTH
RVBA15	150	RVBA70	700	RVBISPO15	150	RVBSU30	300	RVBAC830	800/300	RVBAC950	900/500
RVBA30	300	RVBA80	800	RVBISPO15	150	RVBSU35	350	RVBAC840	800/400	RVBAC960	900/600
RVBA35	350	RVBA90	900	RVBKPO15	150	RVBSU40	400	RVBAC845	800/450	RVBAC140	1000/400
RVBA40	400	RVBA10	1000			RVBSU45	450	RVBAC850	800/500	RVBAC145	1000/450
RVBA45	450	RVBA12	1200			RVBSU50	500	RVBAC860	800/600	RVBAC10	1000/500
RVBA50	500					RVBSU60	600	RVBAC940	900/400	RVBAC160	1000/600
RVBA60	600							RVBAC945	900/450	RVBAC12	1200/600

Standard Mechanism inc.  
Kesseböhmer Mechanism inc.  
Kesseböhmer Mechanism & Towel rail inc.

Bi-fold hinge system Flatpack  
Incl. Corner Post & Blanking Panel

BUILT UNDER OVEN 2 DRAWER BASE 3 DRAWER BASE LOW WALL MEDIUM WALL

H:720mm CODE	WIDTH	H:720mm CODE	WIDTH	H:720mm CODE	WIDTH	H:720mm CODE	WIDTH	D:300mm CODE	WIDTH	D:300mm CODE	WIDTH
RBUE060*	600	RVBD250	500	RVBD350	500	RVWU30-5	300	RVWU80-5	800	RVWU30-7	300
		RVBD260	600	RVBD360	600	RVWU40-5	400	RVWU90-5	900	RVWU35-7	350
		RVBD280	800	RVBD380	800	RVWU45-5	450	RVWU10-5	1000	RVWU40-7	400
		RVBD290	900	RVBD390	900	RVWU50-5	500			RVWU45-7	450
		RVBD210	1000	RVBD210	1000	RVWU60-5	600			RVWU50-7	500
										RVWU60-7	600

\*Non-verse spec.  
2x325mm Drawers  
2x160mm, 1x325mm Drawers  
Add 'X' to the end of the code for 350mm deep  
Add 'X' to the end of the code for 350mm deep

MEDIUM WALL TALL WALL

H:720mm CODE	D:300mm WIDTH	H:720mm CODE	D:300mm WIDTH	H:720mm CODE	D:300mm WIDTH	H:900mm CODE	D:300mm WIDTH	H:900mm CODE	D:300mm WIDTH	H:900mm CODE	D:300mm WIDTH
RVWU160-7	600x600	RVBFWU50-7	500	RVWGR50-7	500	RVWU30-9	300	RVWU80-9	800	RVWU30-9	300
		RVBFWU60-7	600	RVWGR10-7	1000	RVWU40-9	400	RVWU90-9	900	RVWU35-9	350
		RVBFWU80-7	800			RVWU45-9	450	RVWU10-9	1000	RVWU40-7	400
		RVBFWU90-7	900			RVWU50-9	500			RVWU45-7	450
		RVBFWU10-7	1000			RVWU60-9	600			RVWU50-7	500

Bi-Fold Hinge System  
Mechanism inc.  
Add 'X' to the end of the code for 350mm deep  
Reeded glass  
Add 'X' to the end of the code for 350mm deep  
Reeded glass  
Add 'X' to the end of the code for 350mm deep

HORIZONTAL WALL MIDDY UNITS LARDER PULL-OUT LARDER INNER DRAWER LARDER

H:290mm CODE	D:300mm WIDTH	H:360mm CODE	D:300mm WIDTH	H:1970mm CODE	WIDTH	H:1970mm CODE	WIDTH	H:2150mm CODE	WIDTH	H:1970mm CODE	WIDTH
RVWU5029	500	RVWU5036	600	RVTLU30	300	RVTLUSD50	500	RVTLU30	300	RVTLID30	300
RVWU6029	600	RVWU6036	600	RVTLU40	400	RVTLUSD60	600	RVTLU40	400	RVTLID40	400
RVWU8029	800	RVWU8036	800	RVTLU50	500			RVTLU50	500	RVTLID50	500
RVWU9029	900	RVWU9036	900	RVTLU60	600			RVTLU60	600	RVTLID60	600
RVWU1029	1000	RVWU1036	1000								

All include Blum Aventos HKS System  
Add 'X' to the end of the code for 350mm deep  
H:1250mm  
RVRLU60  
RVMA160  
RVMD060  
RVMOHS60  
RVRLU60  
RVMA160  
RVMD060  
RVMOHS60

INNER DRAWER LARDER DOUBLE OVEN SINGLE OVEN SINGLE OVEN + COMPACT COMPACT FRIDGE + FRIDGE/FREEZER

H:2150mm CODE	WIDTH	H:1970mm CODE	WIDTH	H:1970mm CODE	WIDTH	H:1970mm CODE	WIDTH	H:1970mm CODE	WIDTH	H:2150mm CODE	WIDTH
RVETLID30	300	RVTOHDD60	600	RVTOHS60	600	RVTOHSC60	600	RVTOHC60	600	RVTF4/60*	600
RVETLID40	400	RVTOHDD60*	600	RVTOHS60*	600	RVTOHSC60*	600	RVTOHC60*	600	RVTF11U/60*	600
RVETLID50	500									RVTF11U/60*	600
RVETLID60	600									RVTF4U/60*	600

1 x Standard, 4 x Deep drawers  
\*For door on door appliances

Note: Furniture codes beginning with the letter 'R' are assembled (rigid), by removing the 'R' the units are supplied unassembled (flat-pack).

END SUPPORT PANELS	CARCASE MFC PANELS	COMBI	CORNICE	PLINTH	PLANT ON END PANELS
H:900mm CODE ESP 900/700 MFC Carcase	WIDTH 600 700	CODE 1970/300 2150/560 2350/660 720/300 900/2000 900/300 MFC Carcase UG**ET Un-Glued 1m Carcase Edging	WXH 300x1970 560x2150 660x2350 300x720 2000x900 300x900 1000x22	Combination Contemporary	H:150mm CODE PL Melamine [Carcase MFC] PLB* Painted VF/B Veneered Filler Painted [inc. 2 long edges] *Includes PST sealing strip

PLANT ON END PANELS	FURNITURE ACCESSORIES	INTEGRATED DOORS	SPARE DOOR FITTINGS	GENERAL ACCESSORIES
22mm Plain Breakfast Bar Back Panel	50mm Mitred End Panel Corner Post [Spare] External Corner Post	Undrilled	Hinges [Hettich Soft Close]	CODE STPWN Set of 2 Door strapping plates LEGSET Set of 4 Adjustable legs PCC/B Painted care kit
H:720mm CODE 900/2000/22B Painted	WXH 2000x900	H:684mm CODE CPH/B 146	CODE SCHINGE90 90 degree [Pair] SCHINGE170 170 degree [Pair]	CODE SCHINGE90 90 degree [Pair] SCHINGE170 170 degree [Pair]

GOLA PROFILES - STANDARD

Base Units	Wall Units	Tall Units
CODE NGPTOP** Top profile NGPMID** Mid profile NGPFIXB Fixing brackets [pack 10] NGPTOPCAP** Top profile end caps [Pr] NGPMIDCAP** Mid profile end caps [Pr]	LENGTH 4100	CODE NGPTOPEXT** Top profile external corner NGPTOPINT** Top profile internal corner NGPMIDEXT** Mid profile external corner NGPMIDINT** Mid profile internal corner NGPILCON In-line connector



Standard colours  
- Matt Black [MB] and Anodised Steel [AS]

GOLA PROFILES - BESPOKE PAINTED - SOLID COLOURS

Base Units	Wall Units	Tall Units
CODE NGPTOP** Top profile NGPMID** Mid profile NGPFIX10 Fixing brackets [pack 10] NGPTOPCAP** Top profile end caps [Pr] NGPMIDCAP** Mid profile end caps [Pr]	LENGTH 3000	CODE NGPTOPEXT** Top profile external corner NGPTOPINT** Top profile internal corner NGPMIDEXT** Mid profile external corner NGPMIDINT** Mid profile internal corner NGPILCON In-line connector



Bespoke solid colours  
- Dark Blue [DB], Grey Blue [GB], Graphite [GR], Leaf [LF], Light Grey [LG], Luna [LU], Peacock [PC] and Stone Blue [SB]

GOLA PROFILES - BESPOKE PAINTED - SHIMMERING COLOURS

Base Units	Wall Units	Tall Units
CODE NGPTOP** Top profile NGPMID** Mid profile NGPFIX10 Fixing brackets [pack 10] NGPTOPCAP** Top profile end caps [Pr] NGPMIDCAP** Mid profile end caps [Pr]	LENGTH 3000	CODE NGPTOPEXT** Top profile external corner NGPTOPINT** Top profile internal corner NGPMIDEXT** Mid profile external corner NGPMIDINT** Mid profile internal corner NGPILCON In-line connector



Bespoke Shimmering Colours  
- Gold Dust [GD] and Rose Gold [RG]

- When installing an integrated under counter appliance, please check the appliance height carefully to establish if it will fit below the top profile [812mm high or less]. The plinth height can be raised slightly to accommodate taller appliances.
- If using free-standing appliances, end panels must be fitted either side of the appliance and the rail profile finishes against the panel, and end caps fitted if required.
- A top rail profile cannot be used with a built-under single oven in the Verse range. The rails must stop on each side of the appliance and end caps fitted.
- When using a 'L' shaped corner wall unit, the Verse wall rail will need to be mitred on site.
- When planning ensure a 30mm gap is left between, or to the side of all Midi & Tall housings for the vertical profile to be fitted.
- When ordering Midi and Tall units, ensure that you specify either LHH [left hand hinge], RHH [right hand hinge] or Double [units with vertical profiles on both sides] to ensure that the unit ordered is supplied with the correct gables.
- When using either a sink or hob, the distance behind the top rail profile to the back of the carcass is 534mm, therefore units may need to be pulled forward from the wall to accommodate your products. See our Verse Technical Guide for further details on this range. Alternatively, you can call our Furniture team for product information.



Scan here to view our Verse Technical Guide.

VERSE  
PRICE GROUP 7 + 8  
**SHOREDITCH**  
PAINT TO ORDER

Special sizes available  
contact us for further information

Colours Options [PG7]: Auburn, Black, Bone, Cashmere, Coal, Cotton, Dusty Rose, Fern, Forest, Mink, Mist, Moss, Navy, Putty, Riptide, Sea Salt, Smoke, Space, Thyme and Twilight.

Bespoke Colour Option [PG8].



**HI-LINE BASE** **HI-LINE CORNER BASE**

**Pull-Out** **Shallow Base [300mm deep]** **'L' Shaped**

H:720mm	CODE	WIDTH	CODE	WIDTH	H:720mm	CODE	WIDTH	CODE	WIDTH	H:720mm	CODE	WIDTH	
RVBA15	150	RVBA70	700	RVBISPO15	150	RVSBU30	300	RVSBU70	700	RVBAC830	800/300	RVBAC950	900/500
RVBA30	300	RVBA80	800	Standard Mechanism inc.		RVSBU35	350	RVSBU80	800	RVBAC80	800/400	RVBAC960	900/600
RVBA35	350	RVBA90	900	RVBKP015	150	RVSBU40	400	RVSBU90	900	RVBAC845	800/450	RVBAC140	1000/400
RVBA40	400	RVBA10	1000	Kesseböhmer Mechanism inc.		RVSBU45	450	RVSBU10	1000	RVBAC850	800/500	RVBAC145	1000/450
RVBA45	450	RVBA12	1200	RVBKTPO15	150	RVSBU50	500			RVBAC860	800/600	RVBAC10	1000/500
RVBA50	500			Kesseböhmer Mechanism & Towel rail inc.		RVSBU60	600			RVBAC940	900/400	RVBAC160	1000/600
RVBA60	600									RVBAC945	900/450	RVBAC12	1200/600

Inc. Corner Post & Blanking Panel

**BUILT UNDER OVEN** **2 DRAWER BASE** **3 DRAWER BASE** **LOW WALL** **MEDIUM WALL**

**'L' Shaped Corner**

H:720mm	CODE	WIDTH	H:720mm	CODE	WIDTH	H:575mm	CODE	WIDTH	D:300mm	CODE	WIDTH	D:300mm	CODE	WIDTH	D:300mm	CODE	WIDTH	D:300mm	CODE	WIDTH	
RBUEG0*	600	RVBD250	500	RVBD350	500	RVWU30-5	300	RVWU80-5	800	RVWU30-7	300	RVWU70-7	700	RVCWL60-7	600x600						
*Non-verse spec.		RVBD260	600	RVBD360	600	RVWU40-5	400	RVWU90-5	900	RVWU35-7	350	RVWU80-7	800	Add 'X' to the end of the code for 350mm deep							
		RVBD280	800	RVBD380	800	RVWU45-5	450	RVWU10-5	1000	RVWU40-7	400	RVWU90-7	900	RVWU40-7	400	RVWU10-7	1000				
		RVBD290	900	RVBD390	900	RVWU50-5	500			RVWU45-7	450			RVWU45-7	450						
		RVBD210	1000	RVBD310	1000	RVWU60-5	600			RVWU50-7	500			RVWU50-7	500						
										RVWU60-7	600										

Add 'X' to the end of the code for 350mm deep

**MEDIUM WALL** **TALL WALL**

**Bi-Fold** **Glazed Door** **Glazed Door - 1 Cross Rail** **Boiler**

H:720mm	D:300mm	CODE	WIDTH	H:720mm	D:300mm	CODE	WIDTH	H:900mm	D:300mm	CODE	WIDTH	H:900mm	D:300mm	CODE	WIDTH	H:900mm	D:400mm	CODE	WIDTH
RVBFU0-7	500	RVWG50-7	500	RVCRWG50-7	500	RVWU30-9	300	RVWG50-9	500	RVCRWG50-9	500	RVWU40-9	400	RVWU80-9	800	RVWU30-7	300	RVCWL60-7	600x600
RVBFU0-7	600	RVWG10-7	1000	RVCRWG10-7	1000	RVWU40-9	400	RVWG10-9	1000	RVCRWG10-9	1000	RVWU45-9	450	RVWU90-9	900	Add 'X' to the end of the code for 350mm deep			
RVBFU0-8	800	RVWGR50-7*	500	Add 'X' to the end of the code for 350mm deep		RVWU45-9	450	RVWGR50-9*	1000	Add 'X' to the end of the code for 350mm deep		RVWU50-9	500	RVWU10-9	1000	RVWU45-7	450		
RVBFU0-9	900	RVWGR10-7*	1000	Add 'X' to the end of the code for 350mm deep		RVWU50-9	500	RVWGR10-9*	1000	Add 'X' to the end of the code for 350mm deep		RVWU60-9	600			RVWU50-7	500		
RVBFU10-7	1000	Add 'X' to the end of the code for 350mm deep		Add 'X' to the end of the code for 350mm deep		RVWU60-9	600			Add 'X' to the end of the code for 350mm deep						RVWU60-7	600		

\*Reeded glass

**HORIZONTAL WALL** **MIDI UNITS** **LARDER** **PULL-OUT LARDER**

**One Cross Rail - Upper Door** **Single Door - Two Cross Rails**

H:290mm	D:300mm	H:360mm	D:300mm	H:1970mm	CODE	WIDTH	H:1970mm	CODE	WIDTH	H:1970mm	CODE	WIDTH	H:2150mm	CODE	WIDTH	H:1970mm	*H:2150mm	CODE	WIDTH
RVHWU029	500	RVHWU036	500	RVTLU30	300	RVCRTLUS30	300	RVCRTLUS30	300	RVTLU30	300	RVTISPOL30	300	RVTLU30	300	RVTISPOL30	300	RVTLU30	300
RVHWU029	600	RVHWU036	600	RVTLU40	400	RVCRTLUS40	400	RVCRTLUS40	400	RVTLU40	400	RVTKPOL30	300	RVTLU40	400	RVTKPOL30	300	RVTLU40	400
RVHWU029	800	RVHWU036	800	RVTLU50	500	RVCRTLUS50	500	RVCRTLUS50	500	RVTLU50	500	Standard Mechanism inc.		RVTLU50	500	RVETISPOL30*	300	RVTLU50	500
RVHWU029	900	RVHWU036	900	RVTLU60	600	RVCRTLUS60	600	RVCRTLUS60	600	RVTLU60	600	RVETKPOL30*	300	RVTLU60	600	RVETISPOL30*	300	RVTLU60	600
RVHWU1029	1000	RVHWU1036	1000									Kesseböhmer Mechanism inc.				RVETKPOL30*	300		

All include Blum Aventos HKS System  
Add 'X' to the end of the code for 350mm deep

**INNER DRAWER LARDER** **DOUBLE OVEN** **SINGLE OVEN** **SINGLE OVEN + COMPACT** **COMPACT** **FRIDGE + FRIDGE/FREEZER**

H:1970mm	CODE	WIDTH	H:2150mm	CODE	WIDTH	H:1970mm	*H:2150mm	CODE	WIDTH	H:1970mm	*H:2150mm	CODE	WIDTH	H:1970mm	*H:2150mm	CODE	WIDTH
RVTLID30	300	RVTLID30	300	RVTOHD60	600	RVTOHS60	600	RVTOHSC60	600	RVTOHC60	600	RVTOHSC60	600	RVTOHC60	600	RVTOHSC60	600
RVTLID40	400	RVTLID40	400	RVTOHDD60	600	RVTOHSD60	600	RVTOHSC60*	600	RVTOHC60*	600	RVTOHSC60*	600	RVTOHC60*	600	RVTOHSC60*	600
RVTLID50	500	RVTLID50	500	RVETOHD60*	600	RVETOHS60*	600										
RVTLID60	600	RVTLID60	600														

1 x Standard, 4 x Deep drawers

Note: Furniture codes beginning with the letter 'R' are assembled (rigid), by removing the 'R' the units are supplied unassembled (flat-pack).

**END SUPPORT PANELS** **CARCASE MFC PANELS** **COMBI** **PLINTH** **Clear Sealing Strip** **PLANT ON END PANELS**

**Combination**

H:900mm	CODE	WIDTH	CODE	WXH	H:28mm	CODE	WIDTH	H:150mm	CODE	WIDTH	CODE	WIDTH	CODE	WXH	CODE	WXH
ESP	600	1970/300	300x1970	2150/560	PCMB	3000	PL	2940	PST	3000	2440/390T/B	390x2440	2440/390P/B	390x2440	2440/650T/B	650x2440
900/700	700	2350/660	660x2350	720/300	Painted			Melamine [Carcase MFC]			950/390T/B	390x950	950/390P/B	390x950	885/650T/B	650x885
MFC Carcase		900/2000	2000x900	900/300				Painted			885/650P/B	650x885	885/650P/B	650x885	T&G face has the superior finish	
		MFC Carcase		MFC Carcase				Veneered Filler Painted [inc. 2 long edges]			NOT Bone, Cotton, Fern, Putty, Riptide, Space & Twilight		NOT Bone, Cotton, Fern, Putty, Riptide, Space & Twilight		Painted	
		UG/**ET	1000x22	Un-Glued 1m Carcase Edging				*Includes PST sealing strip							Plain face has the superior finish	

**PLANT ON END PANELS** **18mm Tongue & Grooved / Plain Reversible Breakfast Bar Panel** **Framed End Panel** **FURNITURE ACCESSORIES** **INTEGRATED DOORS** **SPARE DOOR FITTINGS** **GENERAL ACCESSORIES**

CODE	WXH	CODE	WXH	CODE	WXH	H:684mm	CODE	WIDTH	CODE	WXH	CODE	WXH	
2440/390/B	390x2440	900/2000T/B	2000x900	FEPTH9/B	800x684	CPH/B	146	INT4568	446x684	SCHINGE90	90 degree [Pair]	STPWN	Set of 2
2440/650/B	650x2440	900/2000P/B	2000x900	FEPTH12/B	1060x684	External Corner Post		INT4571	446x715	SCHINGE170	170 degree [Pair]	LEGSET	Set of 4
950/390/B	390x950	900/2000P/B	2000x900	Painted				INT6045	596x450			PCC/B	Painted care kit
885/650/B	650x885	ONLY Bone, Cotton, Fern, Putty, Riptide, Space & Twilight		ONLY Bone, Cotton, Fern, Putty, Riptide, Space & Twilight				INT6068	596x684				
		900/2000/B	2000x900	ONLY Bone, Cotton, Fern, Putty, Riptide, Space & Twilight				INT6071	596x715				

Stays [Blum Aventos]  
HK-S stay [Pair]  
\*[inc mounting brackets]

**GOLA PROFILES - STANDARD**

**Base Units** **Wall Units** **Tall Units**

CODE	LENGTH	CODE	LENGTH	CODE	LENGTH	CODE	LENGTH
NGPTOP**	4100	NGTOPEXT**	3900	NGPV**	2250	NGPFIXVBKT	
Top profile		Top profile external corner		Vertical single profile		Vertical rear fixing bracket [each]	
NGPMID**	4100	NGTOPINT**		NGPVD**	2250	- 4 required per rail	
Mid profile		Top profile internal corner		Vertical double profile		NGPAF580**	
NGPFIXB		NGPMIDEXT**		NGPFIXVS		Appliance filler 580mm	
Fixing brackets [pack 10]		Mid profile external corner		Vertical SINGLE fixing [each]			
NGPTOPCAP**		NGPMIDINT**		- 4 required per rail			
Top profile end caps [Pr]		Mid profile internal corner		NGPFIXVD			
NGPMIDCAP**		NGPILCON		Vertical DOUBLE fixing [each]			
Mid profile end caps [Pr]		In-line connector		- 4 required per rail			



Standard colours  
- Matt Black [MB] and Anodised Steel [AS]

**GOLA PROFILES - BESPOKE PAINTED - SOLID COLOURS**

**Base Units** **Wall Units** **Tall Units**

CODE	LENGTH	CODE	LENGTH	CODE	LENGTH	CODE	LENGTH
NGPTOP**	3000	NGTOPEXT**	3000	NGPV**	2250	NGPFIXVBKT	
Top profile		Top profile external corner		Vertical single profile		Vertical rear fixing bracket [each]	
NGPMID**	3000	NGTOPINT**		NGPVD**	2250	- 4 required per rail	
Mid profile		Top profile internal corner		Vertical double profile		NGPAF580**	
NGPFIX10		NGPMIDEXT**		NGPFIXVS		Appliance filler 580mm	
Fixing brackets [pack 10]		Mid profile external corner		Vertical SINGLE fixing [each]			
NGPTOPCAP**		NGPMIDINT**		- 4 required per rail			
Top profile end caps [Pr]		Mid profile internal corner		NGPFIXVD			
NGPMIDCAP**		NGPILCON		Vertical DOUBLE fixing [each]			
Mid profile end caps [Pr]		In-line connector		- 4 required per rail			



Bespoke solid colours  
- Dark Blue [DB], Grey Blue [GB], Graphite [GR], Leaf [LF], Light Grey [LG], Luna [LU], Peacock [PC] and Stone Blue [SB]

**GOLA PROFILES - BESPOKE PAINTED - SHIMMERING COLOURS**

**Base Units** **Wall Units** **Tall Units**

CODE	LENGTH	CODE	LENGTH	CODE	LENGTH	CODE	LENGTH
NGPTOP**	3000	NGTOPEXT**	3000	NGPV**	2250	NGPFIXVBKT	
Top profile		Top profile external corner		Vertical single profile		Vertical rear fixing bracket [each]	
NGPMID**	3000	NGTOPINT**		NGPVD**	2250	- 4 required per rail	
Mid profile		Top profile internal corner		Vertical double profile		NGPAF580**	
NGPFIX10		NGPMIDEXT**		NGPFIXVS		Appliance filler 580mm	
Fixing brackets [pack 10]		Mid profile external corner		Vertical SINGLE fixing [each]			
NGPTOPCAP**		NGPMIDINT**		- 4 required per rail			
Top profile end caps [Pr]		Mid profile internal corner		NGPFIXVD			
NGPMIDCAP**		NGPILCON		Vertical DOUBLE fixing [each]			
Mid profile end caps [Pr]		In-line connector		- 4 required per rail			



Bespoke Shimmering Colours  
- Gold Dust [GD] and Rose Gold [RG]

- When installing an integrated under counter appliance, please check the appliance height carefully to establish if it will fit below the top profile [812mm high or less]. The plinth height can be raised slightly to accommodate taller appliances.
- If using free-standing appliances, end panels must be fitted either side of the appliance and the rail profile finishes against the panel, and end caps fitted if required.
- A top rail profile cannot be used with a built-under single oven in the Verse range. The rails must stop on each side of the appliance and end caps fitted.
- When using a 'L' shaped corner wall unit, the Verse wall rail will need to be mitred on site.
- When planning ensure a 30mm gap is left between, or to the side of all Midi & Tall housings for the vertical profile to be fitted.
- When ordering Midi and Tall units, ensure that you specify either LHH [left hand hinge



VERSE  
PRICE GROUP 3  
**ZETA**  
GLOSS + MATT

Special sizes available  
contact us for further information

Gloss Colours Options [PG3]: Cashmere, Grey and White  
Matt Colours Options [PG3]: Aegean, Blue Marble, Cashmere, Dust Grey, Graphite, Grey, Rose Marble and White.



**HI-LINE BASE** **HI-LINE CORNER BASE**

Pull-Out				Shallow Base [300mm deep]				'L' Shaped			
H:720mm CODE	WIDTH	CODE	WIDTH	H:720mm CODE	WIDTH	CODE	WIDTH	H:720mm CODE	WIDTH	CODE	WIDTH
RVBA15	150	RVBA60	600	RVBISPO15	150	RVSBU30	300	RVSBU70	700	RVBAC830	800/300
RVBA26	260	RVBA70	700	Standard Mechanism inc.		RVSBU35	350	RVSBU80	800	RVBAC80	800/400
RVBA30	300	RVBA80	800	RVBKPO15	150	RVSBU40	400	RVSBU90	900	RVBAC845	800/450
RVBA35	350	RVBA90	900	Kesseböhmer Mechanism inc.		RVSBU45	450	RVSBU10	1000	RVBAC850	800/500
RVBA40	400	RVBA10	1000	RVBKTP015	150	RVSBU50	500			RVBAC860	800/600
RVBA45	450	RVBA12	1200	Kesseböhmer Mechanism & Towel rail inc.		RVSBU60	600			RVBAC890	900/400
RVBA50	500									RVBAC945	900/450

Inc. Corner Post & Blanking Panel

**BUILT UNDER OVEN** **2 DRAWER BASE** **3 DRAWER BASE** **LOW WALL** **MEDIUM WALL**

H:720mm CODE	WIDTH	H:720mm CODE	WIDTH	H:720mm CODE	WIDTH	H:575mm CODE	WIDTH	H:720mm CODE	WIDTH	D:300mm CODE	WIDTH
RBU060*	600	RVBD230	300	RVBD330	300	RVWU30-5	300	RVWU80-5	800	RVWU26-7	260
		RVBD240	400	RVBD340	400	RVWU40-5	400	RVWU90-5	900	RVWU30-7	300
		RVBD250	500	RVBD350	500	RVWU45-5	450	RVWU10-5	1000	RVWU35-7	350
		RVBD260	600	RVBD360	600	RVWU50-5	500			RVWU40-7	400
		RVBD280	800	RVBD380	800	RVWU60-5	600			RVWU45-7	450
		RVBD290	900	RVBD390	900					RVWU50-7	500
		RVBD210	1000	RVBD310	1000						

\*Non-verse spec.

2x160mm, 1x325mm Drawers

2x325mm Drawers

Add 'X' to the end of the code for 350mm deep

**MEDIUM WALL** **TALL WALL** **HORIZONTAL WALL**

'L' Shaped Corner		Bi-Fold		Boiler	
H:720mm CODE	D:300mm WIDTH	H:720mm CODE	D:300mm WIDTH	H:900mm CODE	D:300mm WIDTH
RVCWL60-7	600x600	RVBFWU50-7	500	RVWU30-9	300
Add 'X' to the end of the code for 350mm deep [650x650]		RVBFWU60-7	600	RVWU40-9	400
Bi-Fold Hinge System		RVBFWU80-7	800	RVWU45-9	450
		RVBFWU90-7	900	RVWU50-9	500
		RVBFWU10-7	1000	RVWU60-9	600

Mechanism inc.

Add 'X' to the end of the code for 350mm deep

Add 'X' to the end of the code for 350mm deep

All include Blum Aventos HKS System

Add 'X' to the end of the code for 350mm deep

**MIDI UNITS** **LARDER** **PULL-OUT LARDER** **INNER DRAWER LARDER**

MIDI UNITS		LARDER		PULL-OUT LARDER		INNER DRAWER LARDER	
H:1250mm CODE	WIDTH	H:1970mm CODE	WIDTH	H:1970mm CODE	WIDTH	H:1970mm CODE	WIDTH
RVRMLU60	600	RVTLU30	300	RVTLUSD30	300	RVTLID30	300
RVMA160	600	RVTLU40	400	RVTLUSD40	400	RVTLID40	400
RVMD060	600	RVTLU50	500	RVTLUSD50	500	RVTLID50	500
RVMOH560	600	RVTLU60	600	RVTLUSD60	600	RVTLID60	600

Standard Mechanism inc.

Kesseböhmer Mechanism inc.

1x Standard, 4x Deep Drawers

**DOUBLE OVEN** **SINGLE OVEN** **SINGLE OVEN + COMPACT** **COMPACT** **FRIDGE + FRIDGE/FREEZER**

DOUBLE OVEN		SINGLE OVEN		SINGLE OVEN + COMPACT		COMPACT		FRIDGE + FRIDGE/FREEZER	
H:1970mm CODE	WIDTH	H:1970mm CODE	WIDTH	H:1970mm CODE	WIDTH	H:1970mm CODE	WIDTH	H:1970mm CODE	WIDTH
RVTOHD60	600	RVTOHS60	600	RVTOHSC60	600	RVTOHC60	600	RVTF1/60	600
RVTOHDD60	600	RVTOHSD60	600	RVTOHSC60*	600	RVTOHC60*	600	RVTF4/60*	600
RVTOHDD60*	600	RVTOHSD60*	600					RVTF1U/60*	600
								RVTF4U/60*	600

\*Doors undrilled

\*For door on door appliances

Note: Furniture codes beginning with the letter 'R' are assembled (rigid), by removing the 'R' the units are supplied unassembled (flat-pack).

**END SUPPORT PANELS** **CARCASE MFC PANELS** **COMBI** **PLINTH** **PLANT ON END PANELS**

END SUPPORT PANELS		CARCASE MFC PANELS		COMBI		PLINTH		PLANT ON END PANELS	
H:900mm CODE	WIDTH	CODE	WXH	CODE	WXH	H:36mm CODE	WXD	H:150mm CODE	WIDTH
ESP	600	1970/300	300x1970	UG**ET	1000x22	UPCM/P*	2740x55	PL	2940
900/700	700	2150/560	560x2150	10ET/P*	10mtr	Can also be used as a 36mm wide end post - rebated for plant-on end panels		PST	3000
MFC Carcase		2350/660	660x2350	Un-glued Edging Tape 10mtr				2400/650/18P*	650x2400
		720/300	300x720	Door Finish				900/350/18P*	350x900
		900/2000	2000x900	*M = Matt / G = Gloss				900/650/18P*	650x900
		900/300	300x900					Door Finish	

**PLANT ON END PANELS** **FURNITURE ACCESSORIES** **INTEGRATED DOORS** **SPARE DOOR FITTINGS** **GENERAL ACCESSORIES**

PLANT ON END PANELS		FURNITURE ACCESSORIES		INTEGRATED DOORS		SPARE DOOR FITTINGS		GENERAL ACCESSORIES	
18mm Breakfast Bar Panel	46mm Mitred End Panel	Corner Post [Spare]	Undrilled	Hinges [Hettich Soft Close]	STAYHKS	STAYHKS	STAYHKS	STAYHKS	STAYHKS
900/1200/18P*	1200x900	MIEP9B/P*	900x325	CPTH/P*	146	INT4568	446x684	INT6068	596x684
900/2400/18P*	2400x900	MIEP9A/P*	900x684	Flat panel for on site conversion		INT4571	446x715	INT6071	596x715
Door Finish		MIEP12B/P*	1160x325	*M = Matt / G = Gloss		INT6045	596x450		
*M = Matt / G = Gloss		MIEP12A/P*	1160x684						
		Door Finish							
		*M = Matt / G = Gloss							

**GOLA PROFILES - STANDARD**

Base Units		Wall Units		Tall Units	
CODE	LENGTH	CODE	LENGTH	CODE	LENGTH
NGPTOP**	4100	NGPTOPEX**	3900	NGPVS**	2250
Top profile		Top profile external corner		Vertical single profile	
NGPMID**	4100	NGPTOPINT**		NGPVD**	2250
Mid profile		Top profile internal corner		Vertical double profile	
NGPFIXB		NGPMIDEXT**		NGPFIXVS	
Fixing brackets [pack 10]		Mid profile external corner		Vertical SINGLE fixing [each]	
NGPTOPCAP**		NGPMIDINT**		- 4 required per rail	
Top profile end caps [Pr]		Mid profile internal corner		NGPFIXVD	
NGPMIDCAP**		NGPILCON		Vertical DOUBLE fixing [each]	
Mid profile end caps [Pr]		In-line connector		- 4 required per rail	

Standard colours  
- Matt Black [MB] and Anodised Steel [AS]

**GOLA PROFILES - BESPOKE PAINTED - SOLID COLOURS**

Base Units		Wall Units		Tall Units	
CODE	LENGTH	CODE	LENGTH	CODE	LENGTH
NGPTOP**	3000	NGPTOPEX**	3000	NGPVS**	2250
Top profile		Top profile external corner		Vertical single profile	
NGPMID**	3000	NGPTOPINT**		NGPVD**	2250
Mid profile		Top profile internal corner		Vertical double profile	
NGPFIX10		NGPMIDEXT**		NGPFIXVS	
Fixing brackets [pack 10]		Mid profile external corner		Vertical SINGLE fixing [each]	
NGPTOPCAP**		NGPMIDINT**		- 4 required per rail	
Top profile end caps [Pr]		Mid profile internal corner		NGPFIXVD	
NGPMIDCAP**		NGPILCON		Vertical DOUBLE fixing [each]	
Mid profile end caps [Pr]		In-line connector		- 4 required per rail	

Bespoke solid colours  
- Dark Blue [DB], Grey Blue [GB], Graphite [GR], Leaf [LF], Light Grey [LG], Luna [LU], Peacock [PC] and Stone Blue [SB]

**GOLA PROFILES - BESPOKE PAINTED - SHIMMERING COLOURS**

Base Units		Wall Units		Tall Units	
CODE	LENGTH	CODE	LENGTH	CODE	LENGTH
NGPTOP**	3000	NGPTOPEX**	3000	NGPVS**	2250
Top profile		Top profile external corner		Vertical single profile	
NGPMID**	3000	NGPTOPINT**		NGPVD**	2250
Mid profile		Top profile internal corner		Vertical double profile	
NGPFIX10		NGPMIDEXT**		NGPFIXVS	
Fixing brackets [pack 10]		Mid profile external corner		Vertical SINGLE fixing [each]	
NGPTOPCAP**		NGPMIDINT**		- 4 required per rail	
Top profile end caps [Pr]		Mid profile internal corner		NGPFIXVD	
NGPMIDCAP**		NGPILCON		Vertical DOUBLE fixing [each]	
Mid profile end caps [Pr]		In-line connector		- 4 required per rail	

Bespoke Shimmering Colours  
- Gold Dust [GD] and Rose Gold [RG]

- When installing an integrated under counter appliance, please check the appliance height carefully to establish if it will fit below the top profile [812mm high or less]. The plinth height can be raised slightly to accommodate taller appliances.
  - If using free-standing appliances, end panels must be fitted either side of the appliance and the rail profile finishes against the panel, and end caps fitted if required.
  - A top rail profile cannot be used with a built-under single oven in the Verse range. The rails must stop on each side of the appliance and end caps fitted.
  - When using an 'L' shaped corner wall unit, the Verse wall rail will need to be mitred on site.
  - When planning ensure a 30mm gap is left between, or to the side of all Midi & Tall housings for the vertical profile to be fitted.
  - When ordering Midi and Tall units, ensure that you specify either LHH [left hand hinge], RHH [right hand hinge] or Double [units with vertical profiles on both sides] to ensure that the unit ordered is supplied with the correct gables.
  - When using either a sink or hob, the distance behind the top rail profile to the back of the carcass is 534mm, therefore units may need to be pulled forward from the wall to accommodate your products.
- See our Verse Technical Guide for further details on this range. Alternatively, you can call our Furniture team for product information.

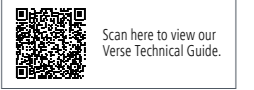



## Shaker.

If your style is traditionally English, contemporary country, or naturally rustic, have a look at the kitchens in our Shaker collection.

Caple's shaker kitchens are characterised by elegant details, rich woods, and subtle colours, put together with our high standards of build and attention to detail.





SHAKER  
PRICE GROUP 7  
**FELTON**  
PAINT TO ORDER

Colours Options [PG7]: Antique Red, Black, Blush, Charcoal, Dark Sage, Dust Grey, Federal Blue, Fern, Gunmetal, Heritage Green, Hunter, Indigo, Ink, Light Grey, Midnight Blue, Mussel, Palladian Blue, Pebble, Porcelain, Sage, Stone Grey, Storm and Woodland Grey.



HI-LINE BASE LOW BASE HI-LINE CORNER BASE

HI-LINE BASE		LOW BASE		HI-LINE CORNER BASE	
CODE	WIDTH	CODE	WIDTH	CODE	WIDTH
RBA15	150	RBA30	300	RBA45	450
RBA30	300	RBA60	600	RBA90	900
RBA35	350	RBA70	700	RBA120	1200
RBA40	400	RBA80	800		
RBA45	450	RBA90	900		
RBA50	500	RBA10	1000		
RBA60	600	RBA12	1200		

\*No muntin [2x300 doors] # 2 x Doors

HI-LINE CORNER BASE DRAWERLINE BASE DRAWERLINE SINK BASE CERAMIC SINK BASE DRAWERLINE CORNER BASE BUILT UNDER

HI-LINE CORNER BASE		DRAWERLINE BASE		DRAWERLINE SINK BASE		CERAMIC SINK BASE		DRAWERLINE CORNER BASE		BUILT UNDER	
CODE	WIDTH	CODE	WIDTH	CODE	WIDTH	CODE	WXH	CODE	WIDTH	CODE	WIDTH
BAC90	900x900	RBD30	300	RBD80/1	800	RBD50	500	RBD830	800/300	RBU060	600
RBD40	400	RBD90/1	900	RBD60	600	RBD845	800/450	RBD880	800/400		
RBD45	450	RBD10/1	1000	RBD70	700	RBD850	800/500	RBD900	900/500		
RBD50	500			RBD80	800	RBD860	800/600	RBD950	900/600		
RBD60	600			RBD90	900			RBD1000	1000/600		
RBD80	800			RBD10	1000						
RBD90	900			RBD12	1200						
RBD10	1000										
RBD12	1200										

\*One working drawer # 2 x Doors

2 DRAWER BASE 3 DRAWER BASE 4 DRAWER BASE 5 DRAWER BASE LOW WALL

2 DRAWER BASE		3 DRAWER BASE		4 DRAWER BASE		5 DRAWER BASE		LOW WALL	
CODE	WIDTH	CODE	WIDTH	CODE	WIDTH	CODE	WIDTH	CODE	WIDTH
RBD250	500	RBD350	500	RBD450	500	RBD530	300	RWU30-5	300
RBD260	600	RBD360	600	RBD460	600	RBD540	400	RWU40-5	400
RBD280	800	RBD380	800	RBD480	800	RBD545	450	RWU45-5	450
RBD290	900	RBD390	900	RBD490	900	RBD550	500	RWU50-5	500
RBD210	1000	RBD310	1000	RBD410	1000	RBD560	600	RWU60-5	600

Add 'X' to the end of the code for 350mm deep

MEDIUM WALL

MEDIUM WALL		Diagonal Corner		'L' Shaped Corner		Conventional Corner		Splayed		Microwave Wall		Bi-Fold	
CODE	WIDTH	CODE	WIDTH	CODE	WIDTH	CODE	WIDTH	CODE	WIDTH	CODE	WIDTH	CODE	WIDTH
RWU30-7	300	RWU60-7*	600	RCWD60-7	600x600	RCWL60-7	600x600	RWU60-7	600	RMWU60-7	600	RBFWU50-7	500
RWU35-7	350	RWU70-7*	700									RBFWU60-7	600
RWU40-7	400	RWU80-7*	800									RBFWU80-7	800
RWU45-7	450	RWU90-7*	900									RBFWU90-7	900
RWU50-7	500	RWU10-7*	1000									RBFWU10-7	1000

Add 'X' to the end of the code for 350mm deep

TALL WALL

TALL WALL		Diagonal Corner		Splayed		Boiler Wall		HORIZONTAL WALL	
CODE	WIDTH	CODE	WIDTH	CODE	WIDTH	CODE	WIDTH	CODE	WIDTH
RWU30-9	300	RWU60-9*	600	RCWD60-9	600x600	RAWU360-9	360	RHWU5029	500
RWU40-9	400	RWU80-9*	800					RHWU6029	600
RWU45-9	450	RWU90-9*	900					RHWU8029	800
RWU50-9	500	RWU10-9*	1000					RHWU9029	900
RWU60-9	600							RHWU1029	1000

Add 'X' to the end of the code for 350mm deep

Note: Furniture codes beginning with the letter 'R' are assembled (rigid), by removing the 'R' the units are supplied unassembled (flat-pack).

OPEN WALL

OPEN WALL		H:290mm		H:360mm		H:575mm		H:720mm		H:900mm		H:1210mm	
CODE	WIDTH	CODE	WIDTH	CODE	WIDTH	CODE	WIDTH	CODE	WIDTH	CODE	WIDTH	CODE	WIDTH
RWOS50-2	500	RWOS50-3	500	RWOS30-5	300	RWOS30-7	300	RWOS30-9	300	RDC1/50	500	RMLU60	600
RWOS60-2	600	RWOS60-3	600	RWOS40-5	400	RWOS40-7	400	RWOS40-9	400	RDC1/60	600	RMA160	600
RWOS80-2	800	RWOS80-3	800	RWOS45-5	450	RWOS45-7	450	RWOS45-9	450			RMD060	600
RWOS90-2	900	RWOS90-3	900	RWOS50-5	500	RWOS50-7	500	RWOS50-9	500			RMOH560	600
RWOS10-2	1000	RWOS10-3	1000	RWOS60-5	600	RWOS60-7	600	RWOS60-9	600				

If 350mm deep carcass is required adjust code, e.g. RWOS1035-2

LARDER

LARDER		Drawer Larder		'L' Shaped		Diagonal		Diagonal Walk-in Larder	
CODE	WIDTH	CODE	WIDTH	CODE	WIDTH	CODE	WIDTH	CODE	WIDTH
RTLU30	300	RTLU30	300	TDLU80	800	TCLU98	985x985	TDCLU1003	1003x1003
RTLU40	400	RETLU40	400	TDLU10	1000	ETCLU98*	985x985	ETDCLU1003*	1003x1003
RTLU50	500	RETLU50	500					ETDWIL1144*	1144x1144
RTLU60	600	RETLU60	600						
TLU80	800	RETLU60/1*	600						
TLU10	1000	ETLU80	800						
		ETLU10	1000						

\*715mm bottom, 1425mm top door

INNER DRAWER LARDER DOUBLE OVEN SINGLE OVEN SINGLE OVEN + COMPACT COMPACT TALL FRIDGE/FREEZER

INNER DRAWER LARDER		DOUBLE OVEN		SINGLE OVEN		SINGLE OVEN + COMPACT		COMPACT		TALL FRIDGE/FREEZER	
CODE	WIDTH	CODE	WIDTH	CODE	WIDTH	CODE	WIDTH	CODE	WIDTH	CODE	WIDTH
RTLID30	300	RETLID30	300	RTOHD60	600	RTOHSD60	600	RTOHSC60	600	RTFF1/60	600
RTLID40	400	RETLID40	400	RTOHDD60*	600	RTOHSD60*	600	RTOHSC60*	600	RTFF2/60	600
RTLID50	500	RETLID50	500							RTFF3/60*	600
RTLID60	600	RETLID60	600							RTFF1U/60*	600
										RTFF2U/60*	600
										RTFF3U/60*	600

1 x Standard, 4 x Deep drawers

BOX WINE RACKS END SUPPORT PANELS CARCASS MFC PANELS CORNICE + PELMET

BOX WINE RACKS		END SUPPORT PANELS		CARCASS MFC PANELS		CORNICE + PELMET	
CODE	HEIGHT	CODE	WIDTH	CODE	WXH	CODE	WIDTH
RWR125-7	720	ESP	600	1970/300	300x1970	CO/US	3000
RWR250-7*	720	900/700	700	2150/560	560x2150		
RWR125-9	900			2350/660	660x2350		
RWR250-9*	900			720/300	300x720		
RWR125-1210	1210			900/2000	2000x900		
WR125-1970	1970			900/300	300x900		
WR250-1970*	1970			UG/**ET	1000x222		

PLANT ON END PANELS PILASTERS FURNITURE ACCESSORIES

PLANT ON END PANELS		PILASTERS		FURNITURE ACCESSORIES	
CODE	WXH	CODE	WIDTH	CODE	WIDTH
2430/650P/US	650x2430	PI/MOD900US	75	Corner Post [Spare]	
900/650P/US	650x900			Flyover Shelf	
900/650B/US	650x2430			Shelf Edge Moulding	
960/360P/US	360x960				

FURNITURE ACCESSORIES INTEGRATED DOORS SPARE DOOR FITTINGS GENERAL ACCESSORIES

FURNITURE ACCESSORIES		INTEGRATED DOORS		SPARE DOOR FITTINGS		GENERAL ACCESSORIES	
CODE	WXD	CODE	WXH	CODE	WXH	CODE	WXD
LCOR/US	150x448	INT4571	446x715	INT6071	596x715	STPWN	Set of 2
						BLSTAYHKS	Set of 4
							Adjustable legs
							PK 50
							14mm Self Adhesive Carcase Cover Caps

Note: Furniture codes beginning with the letter 'R' are assembled (rigid), by removing the 'R' the units are supplied unassembled (flat-pack).

SHAKER  
PRICE GROUP 5, 7 + 8  
**HALEBURY**  
PAINT TO ORDER

Special sizes available  
contact us for further information

Standard Colours Options [PG5]: Bone, Cotton, Fern, Putty, Riptide, Space, and Twilight.

PTO Colours Options [PG7]: Auburn, Black, Cashmere, Coal, Dusty Rose, Forest, Mink, Mist, Moss, Navy, Sea Salt, Smoke and Thyme.

Bespoke Colour Option [PG8]



HI-LINE BASE LOW BASE HI-LINE CORNER BASE

**HI-LINE BASE**

**Pull-Out**

H:720mm	CODE	WIDTH	CODE	WIDTH
RBA15	150	R2BA60*	600	
RBA26	260	RBA70*	700	
RBA30	300	RBA80*	800	
RBA35	350	RBA90*	900	
RBA40	400	RBA10*	1000	
RBA45	450	RBA12*	1200	
RBA50	500	*No muntin [2x300 doors]		
RBA60	600	# 2 x Doors		

**Curved Door**

H:720mm	CODE	WIDTH
RBISPO15	150	

**Curved Return**

H:720mm	CODE	WIDTH
RCDBA30	300x300	

**Splayed**

H:720mm	CODE	WIDTH
RCRBA26	260x300	

**Shallow Base [300mm deep]**

H:720mm	CODE	WIDTH
RSBU30	300	
RSBU35	350	
RSBU40	400	
RSBU45	450	
RSBU50	500	
RSBU60	600	
RSBU70*	700	
RSBU80*	800	
RSBU90*	900	
RSBU10*	1000	

**'L' Shaped**

H:720mm	CODE	WIDTH
BAC90	900x900	

**Diagonal**

H:720mm	CODE	WIDTH
CDA90	900x900	

**LOW BASE**

H:575mm	CODE	WIDTH
RLBU30	300	
RLBU40	400	
RLBU45	450	
RLBU50	500	
RLBU60	600	
RLBU80*	800	
RLBU90*	900	
RLBU10*	1000	
RLBU12*	1200	

**HI-LINE CORNER BASE**

**Diagonal**

H:720mm	CODE	WIDTH
CDA90	900x900	

HI-LINE CORNER BASE DRAWERLINE BASE DRAWERLINE SINK BASE CERAMIC SINK BASE DRAWERLINE CORNER BASE

**HI-LINE CORNER BASE**

**Single Top Drawer**

H:720mm	CODE	WIDTH
RBAC830	800/300	
RBAC80	800/400	
RBAC845	800/450	
RBAC850	800/500	
RBAC860	800/600	
RBAC940	900/400	
RBAC945	900/450	

**Open End Island Unit**

H:720mm	CODE	WIDTH
RBD30	300	
RBD40	400	
RBD45	450	
RBD50	500	
RBD60	600	
RBD80*	800	
RBD90*	900	
RBD10*	1000	
RBD11*	1000	
RBD12*	1200	

**DRAWERLINE BASE**

H:720mm	CODE	WIDTH
RBAC950	900/500	
RBAC960	900/600	
RBAC140	1000/400	
RBAC145	1000/450	
RBAC160	1000/500	
RBAC12	1200/600	

**DRAWERLINE SINK BASE**

H:720mm	CODE	WIDTH	WXH
RBD50	500	RBSU60	600x460
RBD60	600		
RBD80*	800		
RBD90*	900		
RBD10*	1000		
RBD11*	1000		
RBD12*	1200		

**CERAMIC SINK BASE**

H:720mm	CODE	WIDTH	WXH
OEIU9/B**7	910x500		
OEIU12/B**7	1170x500		

**DRAWERLINE CORNER BASE**

H:720mm	CODE	WIDTH	WXH
RBDC830	800/300		
RBDC80	800/400		
RBDC845	800/450		
RBDC850	800/500		
RBDC860	800/600		
RBDC140	1000/400		
RBDC145	1000/450		
RBDC10	1000/500		
RBDC160	1000/600		
RBDC12	1200/600		

**DRAWERLINE CORNER BASE**

H:720mm	CODE	WIDTH	WXH
RBDC830	800/300		
RBDC80	800/400		
RBDC845	800/450		
RBDC850	800/500		
RBDC860	800/600		
RBDC140	1000/400		
RBDC145	1000/450		
RBDC10	1000/500		
RBDC160	1000/600		
RBDC12	1200/600		

BUILT UNDER 2 DRAWER BASE 3 DRAWER BASE 4 DRAWER BASE 5 DRAWER BASE LOW WALL

**BUILT UNDER**

**Oven**

H:720mm	CODE	WIDTH
RBUM60	600	

**Microwave**

H:720mm	CODE	WIDTH
RBUM60	600	

**2 DRAWER BASE**

H:720mm	CODE	WIDTH
RBD250	500	
RBD260	600	
RBD280	800	
RBD290	900	
RBD210	1000	

**3 DRAWER BASE**

H:720mm	CODE	WIDTH
RBD350	500	
RBD360	600	
RBD380	800	
RBD390	900	
RBD310	1000	

**4 DRAWER BASE**

H:720mm	CODE	WIDTH
RBD450	500	
RBD460	600	
RBD480	800	
RBD490	900	
RBD410	1000	

**5 DRAWER BASE**

H:720mm	CODE	WIDTH
RBD530	300	
RBD540	400	
RBD545	450	
RBD550	500	
RBD560	600	
RBD580	800	
RBD590	900	
RBD510	1000	

**LOW WALL**

H:575mm	CODE	WIDTH	WXH
RWU30-5	300	R2WU60-5*	600
RWU40-5	400	RWU80-5*	800
RWU45-5	450	RWU90-5*	900
RWU50-5	500	RWU10-5*	1000
RWU60-5	600		

**Diagonal Corner**

H:575mm	CODE	D:300mm	WIDTH
RCWD60-5	600x600		

**Splayed**

H:575mm	CODE	D:300mm	WIDTH
RAWU360-5	360		

MEDIUM WALL

**MEDIUM WALL**

**Glazed Door**

H:720mm	CODE	D:300mm	WIDTH
RWU26-7	260	R2WU60-7*	600
RWU30-7	300	RWU70-7*	700
RWU35-7	350	RWU80-7*	800
RWU40-7	400	RWU90-7*	900
RWU45-7	450	RWU10-7*	1000
RWU50-7	500		
RWU60-7*	600		

**Diagonal Corner**

H:720mm	CODE	D:300mm	WIDTH
RCWD60-7	600x600		

**'L' Shaped Corner**

H:720mm	CODE	D:300mm	WIDTH
RCWL60-7	600x600		

**Conventional Corner**

H:720mm	CODE	D:300mm	WIDTH
RWUC60-7	600		

**Splayed**

H:720mm	CODE	D:300mm	WIDTH
RAWU360-7	360		

**Curved Door**

H:720mm	CODE	D:300mm	WIDTH
RCDWU30-7	300x300		

**Microwave Wall**

H:720mm	CODE	D:300mm	WIDTH
RMWU60-7	600		

MEDIUM WALL TALL WALL

**MEDIUM WALL**

**Bi-Fold**

H:720mm	CODE	D:300mm	WIDTH
RBFWU50-7	500		
RBFWU60-7	600		
RBFWU80-7	800		
RBFWU90-7	900		
RBFWU10-7	1000		

**TALL WALL**

H:900mm	CODE	D:300mm	WIDTH
RWU30-9	300		
RWU40-9	400		
RWU45-9	450		
RWU50-9	500		
RWU60-9	600		

**Glazed Door**

H:720mm	CODE	D:300mm	WIDTH
R2WU60-9*	600		
RWU80-9*	800		
RWU90-9*	900		
RWU10-9*	1000		

**Diagonal Corner**

H:900mm	CODE	D:300mm	WIDTH
RCWD60-9	600x600		

**Splayed**

H:900mm	CODE	D:300mm	WIDTH
RAWU360-9	360		

**Boiler Wall**

H:900mm	CODE	D:300mm	WIDTH
BWU6040-9	600		

**HORIZONTAL WALL**

H:290mm	CODE	WIDTH	CODE	WIDTH
RHWU5029	500		RHWU5036	500
RHWU6029	600		RHWU6036	600
RHWU8029	800		RHWU8036	800
RHWU9029	900		RHWU1036	900
RHWU1029	1000		RHWU1036	1000

Note: Furniture codes beginning with the letter 'R' are assembled (rigid), by removing the 'R' the units are supplied unassembled (flat-pack).

GLAZED DRESSER OPEN WALL

**GLAZED DRESSER**

H:1210mm	CODE	WIDTH
RDR2/50	500	
RDRR2/50*	500	

**OPEN WALL**

H:290mm	CODE	WIDTH
RWOS50-2	500	
RWOS60-2	600	
RWOS80-2	800	
RWOS90-2	900	
RWOS10-2	1000	

H:360mm	CODE	WIDTH
RWOS50-3	500	
RWOS60-3	600	
RWOS80-3	800	
RWOS90-3	900	
RWOS10-3	1000	

H:575mm	CODE	WIDTH
RWOS30-5	300	
RWOS40-5	400	
RWOS45-5	450	
RWOS50-5	500	
RWOS60-5	600	
RWOS80-5	800	
RWOS90-5	900	
RWOS10-5	1000	

H:720mm	CODE	WIDTH
RWOS30-7	300	
RWOS40-7	400	
RWOS45-7	450	
RWOS50-7	500	
RWOS60-7	600	
RWOS80-7	800	
RWOS90-7	900	
RWOS10-7	1000	

H:900mm	CODE	WIDTH
RWOS30-9	300	
RWOS40-9	400	
RWOS45-9	450	
RWOS50-9	500	
RWOS60-9	600	
RWOS80-9	800	
RWOS90-9	900	
RWOS10-9	1000	
RDC1/50*	500	
RDC1/60*	600	

**MIDI UNITS**

H:1250mm	CODE	WIDTH
RMLU60	600	
RMA160	600	

H:1250mm	CODE	WIDTH
RMD060	600	
RMOS60	600	

LARDER

**LARDER**

H:1970mm	CODE	WIDTH
RTLU30	300	
RTLU40	400	
RTLU50	500	
RTLU60	600	
TLU80	800	
TLU10	1000	

**Drawer Larder**

H:1970mm	CODE	WIDTH
TDLU80	800	
TDLU10	1000	

**'L' Shaped**

H:1970mm	CODE	WIDTH
TCLU98	985x985	
ETCLU98*	985x985	

**Diagonal Walk-in Larder**

H:1970mm	CODE	WIDTH
TDWIL1144	1144x1144	
ETDWIL1144*	1144x1144	

**Diagonal**

H:1970mm	CODE	WIDTH
TDCLU1003	1003x1003	
ETDCLU1003*	1003x1003	

**PULL-OUT LARDER**

H:1970mm	CODE	WIDTH
RTISPOL30	300	
RTKPOL30	300	
RETISPOL30*	300	
RETKPOL30*	300	

INNER DRAWER LARDER DOUBLE OVEN SINGLE OVEN SINGLE OVEN + COMPACT COMPACT TALL FRIDGE/FREEZER

**INNER DRAWER LARDER**

H:1970mm	CODE	WIDTH
RTLID30	300	
RTLID40	400	
RTLID50	500	
RTLID60	600	

**DOUBLE OVEN**

H:2150mm	CODE	WIDTH
RETLD30	300	
RETLD40	400	
RETLD50	500	
RETLD60	600	

**SINGLE OVEN**

H:1970mm	CODE	WIDTH
RTOHD60	600	
RTOHD60*	600	

**SINGLE OVEN + COMPACT**

H:1970mm	CODE	WIDTH
RTOHS60	600	
RTOHS60*	600	

**COMPACT**

H:1970mm	CODE	WIDTH
RETOSC60	600	
RETOHC60*	600	

**TALL FRIDGE/FREEZER**

H:2150mm	CODE	WIDTH
RTFF1/60	600	
RTFF2/60	600	
RTFF3/60*	600	
RTFF4/60*	600	
RTFF5/60*	600	
RTFF6/60*	600	
RTFF7/60*	600	
RTFF8/60*	600	
RTFF9/60*	600	
RTFF10/60*	600	
RTFF11/60*	600	
RTFF12/60*	600	
RTFF13/60*	600	
RTFF14/60*	600	
RTFF15/60*	600	
RTFF16/60*	600	
RTFF17/60*	600	
RTFF18/60*	600	
RTFF19/60*	600	
RTFF20/60*	600	
RTFF21/60*	600	
RTFF22/60*	600	
RTFF23/60*	600	
RTFF24/60*	600	
RTFF25/60*	600	
RTFF26/60*	600	
RTFF27/60*	600	
RTFF28/60*	600	
RTFF29/60*	600	
RTFF30/60*	600	
RTFF31/60*	600	
RTFF32/60*	600	
RTFF33/60*	600	
RTFF34/60*	600	
RTFF35/60*	600	
RTFF36/60*	600	
RTFF37/60*	600	
RTFF38/60*	600	
RTFF39/60*	600	
RTFF40/60*	600	



**SHAKER**  
**PRICE GROUP 3**  
**HEWISH**  
*Special sizes available*  
 contact us for further information  
 Colours Options [PG 3]: Blue, Cashmere,  
 Dust Grey, Grey, Hunter, Indigo and Mussel.



**HI-LINE BASE**      **LOW BASE**      **HI-LINE CORNER BASE**

**HI-LINE BASE**

**Shallow Base [300mm deep]**

**Pull-Out**

**Splayed**

H:720mm CODE	WIDTH	CODE	WIDTH
RBA15	150	RBA15	150
RBA26	260	RBA26	260
RBA30	300	RBA30	300
RBA35	350	RBA35	350
RBA40	400	RBA40	400
RBA45	450	RBA45	450
RBA50	500	RBA50	500
RBA60	600	RBA60	600

H:720mm CODE	WIDTH	H:720mm CODE	WIDTH
RBISPO15	150	RSBU30	300
RBKPO15	150	RSBU35	350
RBKTO15	150	RSBU40	400
		RSBU45	450
		RSBU50	500
		RSBU60	600
		RSBU70#	700
		RSBU80#	800
		RSBU90#	900
		RSBU10#	1000

H:720mm CODE	WIDTH	H:575mm CODE	WIDTH
RBA15	150	RLBU30	300
RBA26	260	RLBU40	400
RBA30	300	RLBU45	450
RBA35	350	RLBU50	500
RBA40	400	RLBU60	600
RBA45	450	RLBU80#	800
RBA50	500	RLBU90#	900
RBA60	600	RLBU10#	1000

H:720mm CODE	WIDTH	CODE	WIDTH
RBA15	150	RBAC830	800/300
RBA26	260	RBAC830	800/400
RBA30	300	RBAC845	800/450
RBA35	350	RBAC850	800/500
RBA40	400	RBAC860	800/600
RBA45	450	RBAC940	900/400
RBA50	500	RBAC945	900/450
RBA60	600	RBAC950	900/500
		RBAC960	900/600
		RBAC140	1000/400
		RBAC145	1000/450
		RBAC10	1000/500
		RBAC160	1000/600
		RBAC12	1200/600

Inc. Corner Post & Blanking Panel

**HI-LINE CORNER BASE**      **DRAWERLINE BASE**      **DRAWERLINE SINK BASE**      **CERAMIC SINK BASE**      **DRAWERLINE CORNER BASE**

**HI-LINE CORNER BASE**

**Diagonal**

**Single Top Drawer**

H:720mm CODE	WIDTH	H:720mm CODE	WIDTH
BAC90	900x900	RBD30	300
		RBD40	400
		RBD45	450
		RBD50	500
		RBD60	600
		RBD80#	800
		RBD90#	900
		RBD10#	1000
		RBD12#	1200

Bi-fold hinge system Flatpack

Flatpack

H:720mm CODE	WIDTH	H:720mm CODE	WIDTH
RBD30	300	RBDF50	500
RBD40	400	RBDF60	600
RBD45	450	RBDF80#	800
RBD50	500	RBDF90#	900
RBD60	600	RBDF10#	1000
RBD80#	800	RBDD10#	1000
RBD90#	900	RBDD12#	1200
RBD10#	1000		
RBD12#	1200		

\*One working drawer #2 x Doors

H:720mm CODE	WIDTH	H:460mm CODE	*H:500mm WIDTH
RBD30	300	RSBU60	600
RBD40	400		
RBD45	450		
RBD50	500		
RBD60	600		
RBD80#	800		
RBD90#	900		
RBD10#	1000		
RBD12#	1200		

To suit a sink height of 260mm  
To suit a sink height of 220mm

Inc. Corner Post & Blanking Panel

**BUILT UNDER**      **2 DRAWER BASE**      **3 DRAWER BASE**      **4 DRAWER BASE**      **5 DRAWER BASE**      **LOW WALL**

**BUILT UNDER**

**Oven**

**Microwave**

H:720mm CODE	WIDTH	H:720mm CODE	WIDTH
RBU060	600	RBUM60	600

175mm Drawer & 110mm filler

H:720mm CODE	WIDTH	H:720mm CODE	WIDTH
RBD250	500	RBD350	500
RBD260	600	RBD360	600
RBD280	800	RBD380	800
RBD290	900	RBD390	900
RBD210	1000	RBD310	1000
		RBD350/175	500
		RBD360/175	600

2x355mm Drawers

H:720mm CODE	WIDTH	H:720mm CODE	WIDTH
RBD350	500	RBD450	500
RBD400	600	RBD460	600
RBD480	800	RBD480	800
RBD490	900	RBD490	900
RBD1000	1000	RBD410	1000
		RBD350/175	500
		RBD450/175	500
		RBD460/175	600
		RBD510	1000

1x140mm, 2x283mm Drawers  
3x140mm, 1x283mm Drawers  
4x175mm Drawers  
5x140mm Drawers

H:720mm CODE	WIDTH	H:575mm CODE	WIDTH
RWU30-5	300	RWU60-5*	600
RWU40-5	400	RWU80-5#	800
RWU45-5	450	RWU90-5#	900
RWU50-5	500	RWU10-5#	1000
RWU60-5	600		

\*No muntin [2x300 doors] #2 x Doors

Add 'X' to the end of the code for 350mm deep

**LOW WALL**      **MEDIUM WALL**

**LOW WALL**

**Diagonal Corner**

**Splayed**

**Feature Glazed**

**Diagonal Corner**

**'L' Shaped Corner**

H:575mm CODE	WIDTH	H:575mm CODE	WIDTH
RCWD60-5	600x600	RAWU360-5	360

Add 'X' to the end of the code for 350mm deep [650x650]

Add 'X' to the end of the code for 350mm deep

H:720mm CODE	WIDTH	H:720mm CODE	WIDTH
RWU26-7	260	R2WU60-7*	600
RWU30-7	300	RWU70-7#	700
RWU35-7	350	RWU80-7#	800
RWU40-7	400	RWU90-7#	900
RWU45-7	450	RWU10-7#	1000
RWU50-7	500		
RWU60-7	600		

\*No muntin [2x300 doors] #2 x Doors

Add 'X' to the end of the code for 350mm deep

H:720mm CODE	WIDTH	H:720mm CODE	WIDTH
RFWU30-7	300	RFWU70-7#	700
RFWU35-7	350	RFWU80-7#	800
RFWU40-7	400	RFWU90-7#	900
RFWU45-7	450	RFWU10-7#	1000
RFWU50-7	500		
RFWU60-7	600		

Clear acrylic glazing #2 x Doors

Add 'X' to the end of the code for 350mm deep

**MEDIUM WALL**      **TALL WALL**

**MEDIUM WALL**

**Conventional Corner**

**Splayed**

**Microwave Wall**

**Diagonal Corner**

**Splayed**

**Boiler Wall**

H:720mm CODE	WIDTH	H:720mm CODE	WIDTH
RWUC60-7	600	RAWU360-7	360

Inc. Corner Post Add 'X' to the end of the code for 350mm deep

Add 'X' to the end of the code for 350mm deep

H:720mm CODE	WIDTH	H:720mm CODE	WIDTH
RMWU60-7	600	RWU30-9	300
		RWU40-9	400
		RWU45-9	450
		RWU50-9	500
		RWU60-9	600

283mm flap, 110mm filler; Mechanism inc.

Add 'X' to the end of the code for 350mm deep

H:900mm CODE	WIDTH	H:900mm CODE	WIDTH
R2WU60-9*	600	RCWD60-9	600x600
RWU80-9#	800		
RWU90-9#	900		
RWU10-9#	1000		

\*No muntin [2x300 doors] #2 x Doors

Add 'X' to the end of the code for 350mm deep

**HORIZONTAL WALL**      **OPEN WALL**

**HORIZONTAL WALL**

**OPEN WALL**

H:290mm CODE	WIDTH	H:360mm CODE	WIDTH
RHWU5029	500	RHWU5036	500
RHWU6029	600	RHWU6036	600
RHWU8029	800	RHWU8036	800
RHWU9029	900	RHWU9036	900
RHWU1029	1000	RHWU1036	1000

Add 'X' to the end of the code for 350mm deep

H:290mm CODE	WIDTH	H:360mm CODE	WIDTH
RWOS50-2	500	RWOS50-3	500
RWOS60-2	600	RWOS60-3	600
RWOS80-2	800	RWOS80-3	800
RWOS90-2	900	RWOS90-3	900
RWOS10-2	1000	RWOS10-3	1000

MFC Carcase

If 350mm deep carcase is required adjust code, e.g. RWOS1035-2

H:575mm CODE	WIDTH	H:720mm CODE	WIDTH
RWOS30-5	300	RWOS30-7	300
RWOS40-5	400	RWOS40-7	400
RWOS45-5	450	RWOS45-7	450
RWOS50-5	500	RWOS50-7	500
RWOS60-5	600	RWOS60-7	600
RWOS80-5	800	RWOS80-7	800
RWOS90-5	900	RWOS90-7	900
RWOS10-5	1000	RWOS10-7	1000

MFC Carcase

If 350mm deep carcase is required adjust code, e.g. RWOS1035-5

H:900mm CODE	WIDTH	H:900mm CODE	WIDTH
RWOS30-9	300	RWOS30-9	300
RWOS40-9	400	RWOS40-9	400
RWOS45-9	450	RWOS45-9	450
RWOS50-9	500	RWOS50-9	500
RWOS60-9	600	RWOS60-9	600
RWOS80-9	800	RWOS80-9	800
RWOS90-9	900	RWOS90-9	900
RWOS10-9	1000	RWOS10-9	1000

MFC Carcase

If 350mm deep carcase is required adjust code, e.g. RDC1/3550

**MIDI UNITS**      **LARDER**

**MIDI UNITS**

**LARDER**

**Single Door**

**Drawer Larder**

**'L' Shaped**

**Diagonal Walk-in Larder**

H:1250mm CODE	WIDTH	H:1250mm CODE	WIDTH
RMLU60	600	RMD060	600
RMA160	600	RMOH560	600

H:1970mm CODE	WIDTH	H:2150mm CODE	WIDTH
RTL30	300	RETLU30	300
RTLU40	400	RETLU40	400
RTLU50	500	RETLU50	500
RTLU60	600	RETLU60	600
TLU80	800	ETLU80	800
TLU10	1000	ETLU10	1000

H:1970mm CODE	WIDTH	H:1970mm CODE	WIDTH
RTL50	500	RTL5D60	600

H:1970mm CODE	WIDTH	H:1970mm CODE	WIDTH
TDLU80	800	TDLU10	1000

2x355 Drawers

H:1970mm CODE	*H:2150mm WIDTH	H:1970mm CODE	*H:2150mm WIDTH
TCLU98	985x985	TDWL1144	1144x1144
ETCLU98*	985x985	ETDWL1144*	1144x1144

Bi-fold hinge system

**LARDER**      **PULL-OUT LARDER**      **INNER DRAWER LARDER**      **DOUBLE OVEN**      **SINGLE OVEN**      **SINGLE OVEN + COMPACT**      **COMPACT**

**LARDER**

**PULL-OUT LARDER**

**INNER DRAWER LARDER**

**DOUBLE OVEN**

**SINGLE OVEN**

**SINGLE OVEN + COMPACT**

**COMPACT**

H:1970mm CODE	*H:2150mm WIDTH	H:1970mm CODE	*H:2150mm WIDTH
TDCLU1003	1003x1003	RTISPOL30	300
ETDCLU1003*	1003x1003	RTKPOL30	300

Standard Mechanism inc.

H:1970mm CODE	WIDTH	H:2150mm CODE	WIDTH
RTL30	300	RETLD30	300
RTLU40	400	RETLD40	400
RTLU50	500	RETLD50	500
RTLU60	600	RETLD60	600

H:1970mm CODE	WIDTH	H:1970mm CODE	WIDTH
RTOHDD60	600	RTOHSD60	600
RETOHDD60*	600	RETOHSD60*	600

H:1970mm CODE	*H:2150mm WIDTH	H:1970mm CODE	*H:2150mm WIDTH
RTOHC60	600	RTOHC60	600
RETOHC60*	600	RETOHC60*	600

1 x Standard, 4 x Deep drawers

**TALL FRIDGE/FREEZER**      **BOX WINE RACKS**      **END SUPPORT PANELS**      **CARCASE MFC PANELS**      **CORNICE**

**TALL FRIDGE/FREEZER**

**BOX WINE RACKS**

**END SUPPORT PANELS**

**CARCASE MFC PANELS**

**CORNICE**

H:1970mm CODE	WIDTH	H:2150mm CODE	WIDTH
RTFF1/60	600	RETFF1/60	600
RTFF4/60*	600	RETFF2/60	600
RTFF1U/60#	600	RETFF1U/60#	600
RTFF4U/60#	600	RETFF2U/60#	600

\*For door on door appliances

W:125mm / W:250mm*	H:900mm CODE	WIDTH
RWR125-7	720	720
RWR250-7*	720	720
RWR125-9	900	900
RWR250-9*	900	900
RWR125-1210	1210	1210
WR125-1970	1970	1970
WR250-1970	1970	1970

MFC Carcase

If using as base order LEGSET

H:900mm CODE	WIDTH	CODE	WXH
ESP	600	1970/300	300x1970
900/700	700	2150/560	560x2150
		2350/660	660x2350
		720/300	300x720
		900/2000	2000x900
		900/300	300x900
		UG/**ET	1000x22

Melamine [Carcase MFC] \*Un-Glued 1m Carcase Edging

H:74mm CODE	WIDTH	H:36mm CODE	WIDTH
CO/PF	2700	UPCM/PF	2740x55

Door Finish

Can also be used as a 36mm wide end post - rebated for plant-on end panels

Door Finish

**PLINTH**      **PLANT ON END PANELS**      **FURNITURE ACCESSORIES**      **INTEGRATED DOORS**      **SPARE DOOR FITTINGS**      **GENERAL ACCS.**

**PLINTH**

**PLANT ON END PANELS**

**FURNITURE ACCESSORIES**

**INTEGRATED DOORS**

**SPARE DOOR FITTINGS**

**GENERAL ACCS.**

H:150mm CODE	WIDTH	CODE	WIDTH
PL	2940	2400/650/18PF	650/2400
		900/650/18PF	650/900
		950/350/18PF	350/950

MFC Carcase Door Finish

H:1050mm CODE
---------------

SHAKER  
PRICE GROUP 2  
**KINGSLEY**

Special sizes available  
contact us for further information

Colours Options [PG 2]: Anthracite, Black, Blush, Cashmere, Dust, Fern, Fjord, Grey, Hunter, Indigo, Mussel, Navy, Porcelain, Terracotta and White.



HI-LINE BASE

Pull-Out				Curved Door				Splayed				Curved Return [300mm deep]				Shallow Base [300mm deep]				LOW BASE													
CODE	WIDTH	CODE	WIDTH	CODE	WIDTH	CODE	WIDTH	CODE	WIDTH	CODE	WIDTH	CODE	WIDTH	CODE	WIDTH	CODE	WIDTH	CODE	WIDTH														
RBA15	150	R2BA60*	600	RBISPO15	150	RCDBA30	300x300	RBA360	360	RCRBA26	260	RSBU30	300	RSBU70*	700	RLBU30	300	RLBU40	400	RLBU45	450	RLBU50	500	RLBU60	600	RLBU80*	800	RLBU90*	900	RLBU10*	1000	RLBU12*	1200
RBA26	260	RBA70*	700	Standard Mechanism inc.								RSBU35	350	RSBU80*	800																		
RBA30	300	RBA80*	800									RSBU40	400	RSBU90*	900																		
RBA35	350	RBA90*	900									RSBU45	450	RSBU10*	1000																		
RBA40	400	RBA10*	1000									RSBU50	500	* 2 x Doors																			
RBA45	450	RBA12*	1200									RSBU60	600																				
RBA50	500	*No muntin [2x300 doors]																															
RBA60	600	# 2 x Doors																															

HI-LINE CORNER BASE

'L' Shaped				Diagonal				DRAWERLINE BASE				DRAWERLINE SINK BASE				CERAMIC SINK BASE					
CODE	WIDTH	CODE	WIDTH	CODE	WIDTH	CODE	WIDTH	CODE	WIDTH	CODE	WIDTH	CODE	WIDTH	CODE	WIDTH	CODE	WIDTH				
RBAC830	800/300	RBAC950	900/500	BAC90	900x900	CDA90	900x900	RBD30	300	RBD80/1	800	RBD50	500	RBD90/1	900	RBD10/1	1000	RBD50	500	RBSU60	600
RBAC80	800/400	RBAC960	900/600	Bi-fold hinge system Flatpack				RBD40	400	RBD90/1	900	RBD60	600	RBD10/1	1000	RBD50	500	To suit a sink height of 260mm			
RBAC845	800/450	RBAC140	1000/400					RBD45	450	RBD10/1	1000	RBD80*	800	RBD90*	900	RBD10*	1000				
RBAC850	800/500	RBAC145	1000/450					RBD50	500	RBD80*	800	RBD10*	1000	RBD12*	1200						
RBAC860	800/600	RBAC10	1000/500					RBD60	600	RBD90*	900	*One working drawer # 2 x Doors									
RBAC940	900/400	RBAC160	1000/600					RBD80*	800	RBD10*	1000										
RBAC945	900/450	RBAC12	1200/600					RBD90*	900	RBD12*	1200										

Inc. Corner Post & Blanking Panel

DRAWERLINE CORNER BASE

DRAWERLINE CORNER BASE				BUILT UNDER		2 DRAWER BASE		3 DRAWER BASE		4 DRAWER BASE		5 DRAWER BASE		LOW WALL							
CODE	WIDTH	CODE	WIDTH	CODE	WIDTH	CODE	WIDTH	CODE	WIDTH	CODE	WIDTH	CODE	WIDTH	CODE	WIDTH						
RBDC830	800/300	RBDC140	1000/400	RBUM60	600	RBDC80	800/400	RBDC145	1000/450	RBDC845	800/450	RBDC10	1000/500	RBDC850	800/500	RBDC160	1000/600	RBDC860	800/600	RBDC12	1200/600
Inc. Corner Post & Blanking Panel				Microwave		2x355mm Drawers		1x140mm, 2x283mm Drawers		3x140mm, 1x283mm Drawers		4x140mm Drawers		5x140mm Drawers		Add 'X' to the end of the code for 350mm deep					
				175mm drawer & 110mm filler		2x175mm, 1x355mm Drawers		2x175mm, 1x355mm Drawers		4x175mm Drawers											

LOW WALL

Diagonal Corner				Splayed				Diagonal Corner				'L' Shaped Corner				Conventional Corner				Splayed		Curved Door											
CODE	WIDTH	CODE	WIDTH	CODE	WIDTH	CODE	WIDTH	CODE	WIDTH	CODE	WIDTH	CODE	WIDTH	CODE	WIDTH	CODE	WIDTH	CODE	WIDTH	CODE	WIDTH	CODE	WIDTH										
RCWD60-5	600x600	RAWU360-5	360	RWU26-7	260	R2WU60-7*	600	RCWD60-7	600x600	RCWL60-7	600x600	RWU30-7	300	RWU70-7*	700	RWU35-7	350	RWU80-7*	800	RWU40-7	400	RWU90-7*	900	RWU45-7	450	RWU10-7*	1000	RWU50-7	500	*No muntin [2x300 doors]			
Add 'X' to the end of the code for 350mm deep [650x650]				Add 'X' to the end of the code for 350mm deep				Add 'X' to the end of the code for 350mm deep [650x650]				Add 'X' to the end of the code for 350mm deep [650x650]				Add 'X' to the end of the code for 350mm deep				Add 'X' to the end of the code for 350mm deep													
				Add 'X' to the end of the code for 350mm deep																													

MEDIUM WALL

Microwave Wall				Bi-Fold				Diagonal Corner				Splayed				Boiler Wall		HORIZONTAL WALL															
CODE	WIDTH	CODE	WIDTH	CODE	WIDTH	CODE	WIDTH	CODE	WIDTH	CODE	WIDTH	CODE	WIDTH	CODE	WIDTH	CODE	WIDTH	CODE	WIDTH	CODE	WIDTH	CODE	WIDTH										
RMWU60-7	600	RBFWU50-7	500	RWU30-9	300	R2WU60-9*	600	RCWD60-9	600x600	RAWU360-9	360	BWU6040-9	600	RHWU5029	500	RHWU5036	500	RHWU6029	600	RHWU6036	600	RHWU8029	800	RHWU8036	800	RHWU9029	900	RHWU9036	900	RHWU1029	1000	RHWU1036	1000
283mm flap, 110mm filler; Mechanism inc.				Add 'X' to the end of the code for 350mm deep				Add 'X' to the end of the code for 350mm deep				Add 'X' to the end of the code for 350mm deep				400mm Deep Flatpack		Add 'X' to the end of the code for 350mm deep															
Add 'X' to the end of the code for 350mm deep				Add 'X' to the end of the code for 350mm deep				Add 'X' to the end of the code for 350mm deep				Add 'X' to the end of the code for 350mm deep																					

Note: Furniture codes beginning with the letter 'R' are assembled (rigid), by removing the 'R' the units are supplied unassembled (flat-pack).

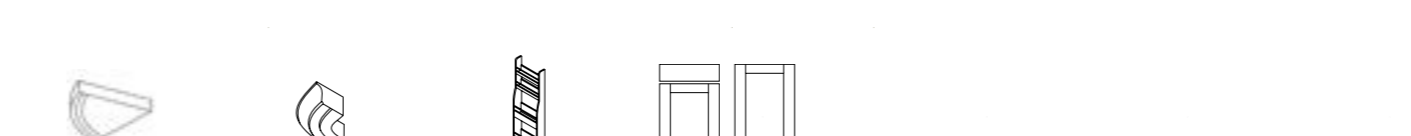
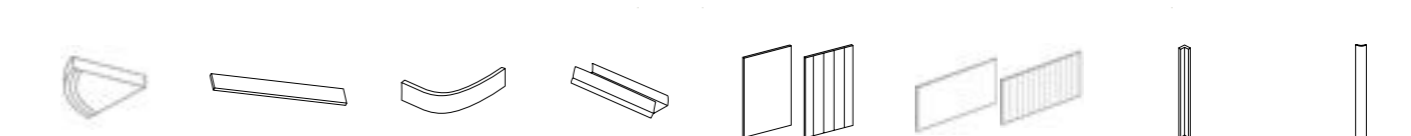
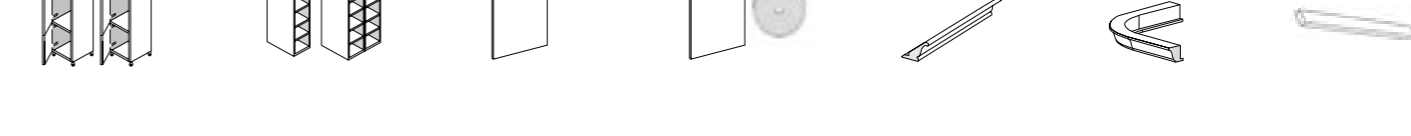
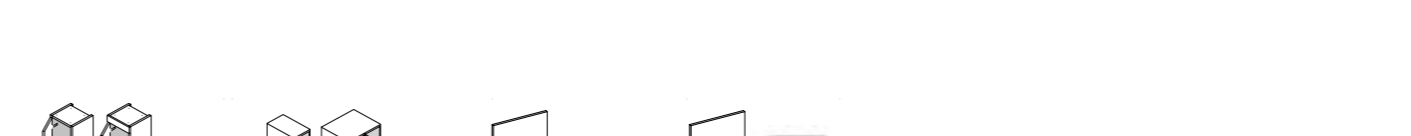
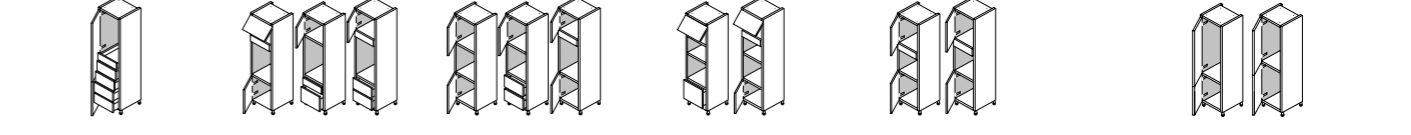
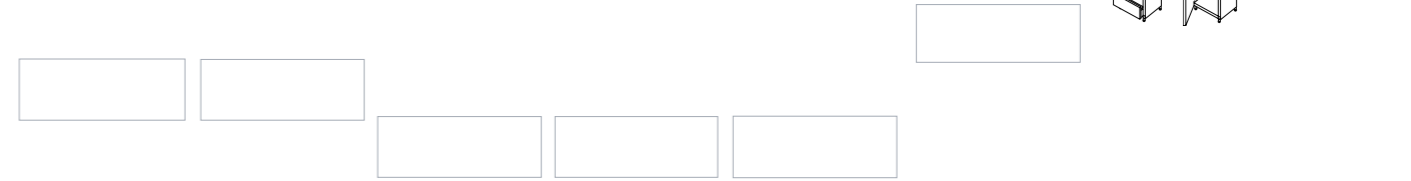
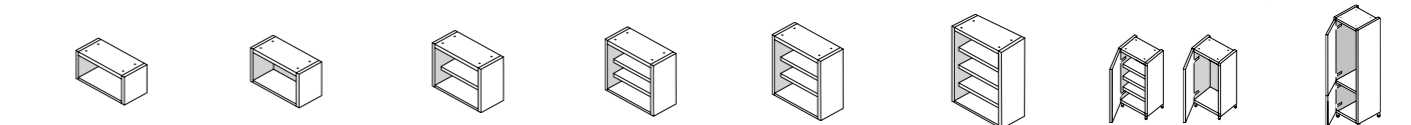

Note: Furniture codes beginning with the letter 'R' are assembled (rigid), by removing the 'R' the units are supplied unassembled (flat-pack).



SHAKER  
PRICE GROUP 5 + 6

**LEIGH**  
PAINT TO ORDER

Special sizes available  
contact us for further information

Leigh Sanded [PG5]

Leigh Oak [PG6]

PTO Colours Options [PG6]: Alabaster, Antique Red, Black, Blush, Charcoal, Dark Sage, Dust Grey, Federal Blue, Fern, Gunmetal, Heritage Green, Hunter, Indigo, Ink, Light Grey, Midnight Blue, Palladian Blue, Pebble, Porcelain, Sage, Stone Grey, Storm and Woodland Grey.



HI-LINE BASE LOW BASE HI-LINE CORNER BASE HI-LINE CORNER BASE

HI-LINE BASE	LOW BASE	HI-LINE CORNER BASE	HI-LINE CORNER BASE																																																																																																																				
<p><b>Drawer</b></p> <table border="1"> <tr><th>H:720mm CODE</th><th>WIDTH</th><th>CODE</th><th>WIDTH</th></tr> <tr><td>RBA15</td><td>150</td><td>RBA26</td><td>260</td></tr> <tr><td>RBA26</td><td>260</td><td>RBA30</td><td>300</td></tr> <tr><td>RBA30</td><td>300</td><td>RBA35</td><td>350</td></tr> <tr><td>RBA40</td><td>400</td><td>RBA45</td><td>450</td></tr> <tr><td>RBA50</td><td>500</td><td>RBA60</td><td>600</td></tr> </table> <p><b>Shallow Base [300mm deep]</b></p> <table border="1"> <tr><th>H:720mm CODE</th><th>WIDTH</th><th>H:720mm CODE</th><th>WIDTH</th></tr> <tr><td>RSBU30</td><td>300</td><td>RSBU35</td><td>350</td></tr> <tr><td>RSBU40</td><td>400</td><td>RSBU45</td><td>450</td></tr> <tr><td>RSBU50</td><td>500</td><td>RSBU60</td><td>600</td></tr> <tr><td>RSBU70</td><td>700</td><td>RSBU80</td><td>800</td></tr> <tr><td>RSBU90</td><td>900</td><td>RSBU10</td><td>1000</td></tr> <tr><td>RSBU10</td><td>1000</td><td></td><td></td></tr> </table> <p><b>'L' Shaped</b></p> <table border="1"> <tr><th>H:720mm CODE</th><th>WIDTH</th><th>H:720mm CODE</th><th>WIDTH</th></tr> <tr><td>RBA15</td><td>150</td><td>RBA26</td><td>260x300</td></tr> </table> <p><b>Diagonal</b></p> <table border="1"> <tr><th>H:720mm CODE</th><th>WIDTH</th></tr> <tr><td>CDA90</td><td>900x900</td></tr> </table>	H:720mm CODE	WIDTH	CODE	WIDTH	RBA15	150	RBA26	260	RBA26	260	RBA30	300	RBA30	300	RBA35	350	RBA40	400	RBA45	450	RBA50	500	RBA60	600	H:720mm CODE	WIDTH	H:720mm CODE	WIDTH	RSBU30	300	RSBU35	350	RSBU40	400	RSBU45	450	RSBU50	500	RSBU60	600	RSBU70	700	RSBU80	800	RSBU90	900	RSBU10	1000	RSBU10	1000			H:720mm CODE	WIDTH	H:720mm CODE	WIDTH	RBA15	150	RBA26	260x300	H:720mm CODE	WIDTH	CDA90	900x900	<p><b>Shallow Base [300mm deep]</b></p> <table border="1"> <tr><th>H:575mm CODE</th><th>WIDTH</th><th>H:720mm CODE</th><th>WIDTH</th></tr> <tr><td>RLBU30</td><td>300</td><td>RLBU40</td><td>400</td></tr> <tr><td>RLBU45</td><td>450</td><td>RLBU50</td><td>500</td></tr> <tr><td>RLBU60</td><td>600</td><td>RLBU80</td><td>800</td></tr> <tr><td>RLBU90</td><td>900</td><td>RLBU10</td><td>1000</td></tr> <tr><td>RLBU12</td><td>1200</td><td></td><td></td></tr> </table> <p><b>Diagonal</b></p> <table border="1"> <tr><th>H:720mm CODE</th><th>WIDTH</th></tr> <tr><td>CDA90</td><td>900x900</td></tr> </table>	H:575mm CODE	WIDTH	H:720mm CODE	WIDTH	RLBU30	300	RLBU40	400	RLBU45	450	RLBU50	500	RLBU60	600	RLBU80	800	RLBU90	900	RLBU10	1000	RLBU12	1200			H:720mm CODE	WIDTH	CDA90	900x900	<p><b>'L' Shaped</b></p> <table border="1"> <tr><th>H:720mm CODE</th><th>WIDTH</th><th>H:720mm CODE</th><th>WIDTH</th></tr> <tr><td>RBA15</td><td>150</td><td>RBA26</td><td>260x300</td></tr> </table> <p><b>Diagonal</b></p> <table border="1"> <tr><th>H:720mm CODE</th><th>WIDTH</th></tr> <tr><td>CDA90</td><td>900x900</td></tr> </table>	H:720mm CODE	WIDTH	H:720mm CODE	WIDTH	RBA15	150	RBA26	260x300	H:720mm CODE	WIDTH	CDA90	900x900	<p><b>Diagonal</b></p> <table border="1"> <tr><th>H:720mm CODE</th><th>WIDTH</th><th>H:720mm CODE</th><th>WIDTH</th></tr> <tr><td>RBA15</td><td>150</td><td>RBA26</td><td>260x300</td></tr> </table> <p><b>Diagonal</b></p> <table border="1"> <tr><th>H:720mm CODE</th><th>WIDTH</th></tr> <tr><td>CDA90</td><td>900x900</td></tr> </table>	H:720mm CODE	WIDTH	H:720mm CODE	WIDTH	RBA15	150	RBA26	260x300	H:720mm CODE	WIDTH	CDA90	900x900
H:720mm CODE	WIDTH	CODE	WIDTH																																																																																																																				
RBA15	150	RBA26	260																																																																																																																				
RBA26	260	RBA30	300																																																																																																																				
RBA30	300	RBA35	350																																																																																																																				
RBA40	400	RBA45	450																																																																																																																				
RBA50	500	RBA60	600																																																																																																																				
H:720mm CODE	WIDTH	H:720mm CODE	WIDTH																																																																																																																				
RSBU30	300	RSBU35	350																																																																																																																				
RSBU40	400	RSBU45	450																																																																																																																				
RSBU50	500	RSBU60	600																																																																																																																				
RSBU70	700	RSBU80	800																																																																																																																				
RSBU90	900	RSBU10	1000																																																																																																																				
RSBU10	1000																																																																																																																						
H:720mm CODE	WIDTH	H:720mm CODE	WIDTH																																																																																																																				
RBA15	150	RBA26	260x300																																																																																																																				
H:720mm CODE	WIDTH																																																																																																																						
CDA90	900x900																																																																																																																						
H:575mm CODE	WIDTH	H:720mm CODE	WIDTH																																																																																																																				
RLBU30	300	RLBU40	400																																																																																																																				
RLBU45	450	RLBU50	500																																																																																																																				
RLBU60	600	RLBU80	800																																																																																																																				
RLBU90	900	RLBU10	1000																																																																																																																				
RLBU12	1200																																																																																																																						
H:720mm CODE	WIDTH																																																																																																																						
CDA90	900x900																																																																																																																						
H:720mm CODE	WIDTH	H:720mm CODE	WIDTH																																																																																																																				
RBA15	150	RBA26	260x300																																																																																																																				
H:720mm CODE	WIDTH																																																																																																																						
CDA90	900x900																																																																																																																						
H:720mm CODE	WIDTH	H:720mm CODE	WIDTH																																																																																																																				
RBA15	150	RBA26	260x300																																																																																																																				
H:720mm CODE	WIDTH																																																																																																																						
CDA90	900x900																																																																																																																						

DRAWERLINE BASE CERAMIC SINK BASE DRAWERLINE CORNER BASE BUILT UNDER

DRAWERLINE BASE	CERAMIC SINK BASE	DRAWERLINE CORNER BASE	BUILT UNDER																																																												
<p><b>Single Top Drawer</b></p> <table border="1"> <tr><th>H:720mm CODE</th><th>WIDTH</th><th>H:720mm CODE</th><th>WIDTH</th></tr> <tr><td>RBD30</td><td>300</td><td>RBD40</td><td>400</td></tr> <tr><td>RBD45</td><td>450</td><td>RBD50</td><td>500</td></tr> <tr><td>RBD60</td><td>600</td><td></td><td></td></tr> </table>	H:720mm CODE	WIDTH	H:720mm CODE	WIDTH	RBD30	300	RBD40	400	RBD45	450	RBD50	500	RBD60	600			<p><b>Single Top Drawer</b></p> <table border="1"> <tr><th>H:720mm CODE</th><th>WIDTH</th><th>H:720mm CODE</th><th>WIDTH</th></tr> <tr><td>RBD80</td><td>800</td><td>RBD90</td><td>900</td></tr> <tr><td>RBD10</td><td>1000</td><td>RBD12</td><td>1200</td></tr> </table>	H:720mm CODE	WIDTH	H:720mm CODE	WIDTH	RBD80	800	RBD90	900	RBD10	1000	RBD12	1200	<p><b>Single Top Drawer</b></p> <table border="1"> <tr><th>H:720mm CODE</th><th>WIDTH</th><th>H:720mm CODE</th><th>WIDTH</th></tr> <tr><td>RBD50</td><td>500</td><td>RBD60</td><td>600</td></tr> <tr><td>RBD80</td><td>800</td><td>RBD90</td><td>900</td></tr> <tr><td>RBD10</td><td>1000</td><td>RBD12</td><td>1200</td></tr> </table>	H:720mm CODE	WIDTH	H:720mm CODE	WIDTH	RBD50	500	RBD60	600	RBD80	800	RBD90	900	RBD10	1000	RBD12	1200	<p><b>Oven</b></p> <table border="1"> <tr><th>H:720mm CODE</th><th>WIDTH</th><th>H:720mm CODE</th><th>WIDTH</th></tr> <tr><td>RBU060</td><td>600</td><td></td><td></td></tr> </table> <p><b>Microwave</b></p> <table border="1"> <tr><th>H:720mm CODE</th><th>WIDTH</th><th>H:720mm CODE</th><th>WIDTH</th></tr> <tr><td>RBUM60</td><td>600</td><td></td><td></td></tr> </table>	H:720mm CODE	WIDTH	H:720mm CODE	WIDTH	RBU060	600			H:720mm CODE	WIDTH	H:720mm CODE	WIDTH	RBUM60	600		
H:720mm CODE	WIDTH	H:720mm CODE	WIDTH																																																												
RBD30	300	RBD40	400																																																												
RBD45	450	RBD50	500																																																												
RBD60	600																																																														
H:720mm CODE	WIDTH	H:720mm CODE	WIDTH																																																												
RBD80	800	RBD90	900																																																												
RBD10	1000	RBD12	1200																																																												
H:720mm CODE	WIDTH	H:720mm CODE	WIDTH																																																												
RBD50	500	RBD60	600																																																												
RBD80	800	RBD90	900																																																												
RBD10	1000	RBD12	1200																																																												
H:720mm CODE	WIDTH	H:720mm CODE	WIDTH																																																												
RBU060	600																																																														
H:720mm CODE	WIDTH	H:720mm CODE	WIDTH																																																												
RBUM60	600																																																														

2 DRAWER BASE 3 DRAWER BASE 4 DRAWER BASE 5 DRAWER BASE LOW WALL

2 DRAWER BASE	3 DRAWER BASE	4 DRAWER BASE	5 DRAWER BASE	LOW WALL																																																																																				
<table border="1"> <tr><th>H:720mm CODE</th><th>WIDTH</th><th>H:720mm CODE</th><th>WIDTH</th></tr> <tr><td>RBD250</td><td>500</td><td>RBD260</td><td>600</td></tr> <tr><td>RBD280</td><td>800</td><td>RBD290</td><td>900</td></tr> <tr><td>RBD1200</td><td>1200</td><td></td><td></td></tr> </table>	H:720mm CODE	WIDTH	H:720mm CODE	WIDTH	RBD250	500	RBD260	600	RBD280	800	RBD290	900	RBD1200	1200			<table border="1"> <tr><th>H:720mm CODE</th><th>WIDTH</th><th>H:720mm CODE</th><th>WIDTH</th></tr> <tr><td>RBD350</td><td>500</td><td>RBD360</td><td>600</td></tr> <tr><td>RBD380</td><td>800</td><td>RBD390</td><td>900</td></tr> <tr><td>RBD410</td><td>1000</td><td></td><td></td></tr> </table>	H:720mm CODE	WIDTH	H:720mm CODE	WIDTH	RBD350	500	RBD360	600	RBD380	800	RBD390	900	RBD410	1000			<table border="1"> <tr><th>H:720mm CODE</th><th>WIDTH</th><th>H:720mm CODE</th><th>WIDTH</th></tr> <tr><td>RBD450</td><td>500</td><td>RBD460</td><td>600</td></tr> <tr><td>RBD480</td><td>800</td><td>RBD490</td><td>900</td></tr> <tr><td>RBD510</td><td>1000</td><td></td><td></td></tr> </table>	H:720mm CODE	WIDTH	H:720mm CODE	WIDTH	RBD450	500	RBD460	600	RBD480	800	RBD490	900	RBD510	1000			<table border="1"> <tr><th>H:720mm CODE</th><th>WIDTH</th><th>H:720mm CODE</th><th>WIDTH</th></tr> <tr><td>RBD530</td><td>300</td><td>RBD540</td><td>400</td></tr> <tr><td>RBD545</td><td>450</td><td>RBD550</td><td>500</td></tr> <tr><td>RBD560</td><td>600</td><td>RBD580</td><td>800</td></tr> <tr><td>RBD590</td><td>900</td><td>RBD510</td><td>1000</td></tr> </table>	H:720mm CODE	WIDTH	H:720mm CODE	WIDTH	RBD530	300	RBD540	400	RBD545	450	RBD550	500	RBD560	600	RBD580	800	RBD590	900	RBD510	1000	<table border="1"> <tr><th>H:575mm CODE</th><th>WIDTH</th><th>H:575mm CODE</th><th>WIDTH</th></tr> <tr><td>RWU30-5</td><td>300</td><td>RWU40-5</td><td>400</td></tr> <tr><td>RWU45-5</td><td>450</td><td>RWU50-5</td><td>500</td></tr> <tr><td>RWU60-5</td><td>600</td><td></td><td></td></tr> </table>	H:575mm CODE	WIDTH	H:575mm CODE	WIDTH	RWU30-5	300	RWU40-5	400	RWU45-5	450	RWU50-5	500	RWU60-5	600		
H:720mm CODE	WIDTH	H:720mm CODE	WIDTH																																																																																					
RBD250	500	RBD260	600																																																																																					
RBD280	800	RBD290	900																																																																																					
RBD1200	1200																																																																																							
H:720mm CODE	WIDTH	H:720mm CODE	WIDTH																																																																																					
RBD350	500	RBD360	600																																																																																					
RBD380	800	RBD390	900																																																																																					
RBD410	1000																																																																																							
H:720mm CODE	WIDTH	H:720mm CODE	WIDTH																																																																																					
RBD450	500	RBD460	600																																																																																					
RBD480	800	RBD490	900																																																																																					
RBD510	1000																																																																																							
H:720mm CODE	WIDTH	H:720mm CODE	WIDTH																																																																																					
RBD530	300	RBD540	400																																																																																					
RBD545	450	RBD550	500																																																																																					
RBD560	600	RBD580	800																																																																																					
RBD590	900	RBD510	1000																																																																																					
H:575mm CODE	WIDTH	H:575mm CODE	WIDTH																																																																																					
RWU30-5	300	RWU40-5	400																																																																																					
RWU45-5	450	RWU50-5	500																																																																																					
RWU60-5	600																																																																																							

MEDIUM WALL

Bi-Fold	TALL WALL	Glazed Door	Diagonal Corner	'L' Shaped Corner	Conventional Corner	Splayed	Curved Door	Microwave Wall																																																																																																				
<table border="1"> <tr><th>H:720mm CODE</th><th>WIDTH</th><th>H:720mm CODE</th><th>WIDTH</th></tr> <tr><td>RWU26-7</td><td>260</td><td>RWU30-7</td><td>300</td></tr> <tr><td>RWU35-7</td><td>350</td><td>RWU40-7</td><td>400</td></tr> <tr><td>RWU45-7</td><td>450</td><td>RWU50-7</td><td>500</td></tr> <tr><td>RWU60-7</td><td>600</td><td></td><td></td></tr> </table>	H:720mm CODE	WIDTH	H:720mm CODE	WIDTH	RWU26-7	260	RWU30-7	300	RWU35-7	350	RWU40-7	400	RWU45-7	450	RWU50-7	500	RWU60-7	600			<table border="1"> <tr><th>H:720mm CODE</th><th>WIDTH</th><th>H:720mm CODE</th><th>WIDTH</th></tr> <tr><td>RWU60-7*</td><td>600</td><td></td><td></td></tr> </table>	H:720mm CODE	WIDTH	H:720mm CODE	WIDTH	RWU60-7*	600			<table border="1"> <tr><th>H:720mm CODE</th><th>WIDTH</th><th>H:720mm CODE</th><th>WIDTH</th></tr> <tr><td>RWG50-7</td><td>500</td><td>RWG10-7</td><td>1000</td></tr> </table>	H:720mm CODE	WIDTH	H:720mm CODE	WIDTH	RWG50-7	500	RWG10-7	1000	<table border="1"> <tr><th>H:720mm CODE</th><th>WIDTH</th><th>H:720mm CODE</th><th>WIDTH</th></tr> <tr><td>RCWD60-7</td><td>600x600</td><td>RCWL60-7</td><td>600x600</td></tr> </table>	H:720mm CODE	WIDTH	H:720mm CODE	WIDTH	RCWD60-7	600x600	RCWL60-7	600x600	<table border="1"> <tr><th>H:720mm CODE</th><th>WIDTH</th><th>H:720mm CODE</th><th>WIDTH</th></tr> <tr><td>RWUC60-7</td><td>600</td><td>RAWU360-7</td><td>360</td></tr> </table>	H:720mm CODE	WIDTH	H:720mm CODE	WIDTH	RWUC60-7	600	RAWU360-7	360	<table border="1"> <tr><th>H:720mm CODE</th><th>WIDTH</th><th>H:720mm CODE</th><th>WIDTH</th></tr> <tr><td>RWU30-7</td><td>300</td><td>RWU40-7</td><td>400</td></tr> <tr><td>RWU45-7</td><td>450</td><td>RWU50-7</td><td>500</td></tr> <tr><td>RWU60-7</td><td>600</td><td></td><td></td></tr> </table>	H:720mm CODE	WIDTH	H:720mm CODE	WIDTH	RWU30-7	300	RWU40-7	400	RWU45-7	450	RWU50-7	500	RWU60-7	600			<table border="1"> <tr><th>H:720mm CODE</th><th>WIDTH</th><th>H:720mm CODE</th><th>WIDTH</th></tr> <tr><td>RWU30-7</td><td>300</td><td>RWU40-7</td><td>400</td></tr> <tr><td>RWU45-7</td><td>450</td><td>RWU50-7</td><td>500</td></tr> <tr><td>RWU60-7</td><td>600</td><td></td><td></td></tr> </table>	H:720mm CODE	WIDTH	H:720mm CODE	WIDTH	RWU30-7	300	RWU40-7	400	RWU45-7	450	RWU50-7	500	RWU60-7	600			<table border="1"> <tr><th>H:720mm CODE</th><th>WIDTH</th><th>H:720mm CODE</th><th>WIDTH</th></tr> <tr><td>RCWU30-7</td><td>300x300</td><td>RCWU60-7</td><td>600x600</td></tr> </table>	H:720mm CODE	WIDTH	H:720mm CODE	WIDTH	RCWU30-7	300x300	RCWU60-7	600x600	<table border="1"> <tr><th>H:720mm CODE</th><th>WIDTH</th><th>H:720mm CODE</th><th>WIDTH</th></tr> <tr><td>RMWU60-7</td><td>600</td><td></td><td></td></tr> </table>	H:720mm CODE	WIDTH	H:720mm CODE	WIDTH	RMWU60-7	600		
H:720mm CODE	WIDTH	H:720mm CODE	WIDTH																																																																																																									
RWU26-7	260	RWU30-7	300																																																																																																									
RWU35-7	350	RWU40-7	400																																																																																																									
RWU45-7	450	RWU50-7	500																																																																																																									
RWU60-7	600																																																																																																											
H:720mm CODE	WIDTH	H:720mm CODE	WIDTH																																																																																																									
RWU60-7*	600																																																																																																											
H:720mm CODE	WIDTH	H:720mm CODE	WIDTH																																																																																																									
RWG50-7	500	RWG10-7	1000																																																																																																									
H:720mm CODE	WIDTH	H:720mm CODE	WIDTH																																																																																																									
RCWD60-7	600x600	RCWL60-7	600x600																																																																																																									
H:720mm CODE	WIDTH	H:720mm CODE	WIDTH																																																																																																									
RWUC60-7	600	RAWU360-7	360																																																																																																									
H:720mm CODE	WIDTH	H:720mm CODE	WIDTH																																																																																																									
RWU30-7	300	RWU40-7	400																																																																																																									
RWU45-7	450	RWU50-7	500																																																																																																									
RWU60-7	600																																																																																																											
H:720mm CODE	WIDTH	H:720mm CODE	WIDTH																																																																																																									
RWU30-7	300	RWU40-7	400																																																																																																									
RWU45-7	450	RWU50-7	500																																																																																																									
RWU60-7	600																																																																																																											
H:720mm CODE	WIDTH	H:720mm CODE	WIDTH																																																																																																									
RCWU30-7	300x300	RCWU60-7	600x600																																																																																																									
H:720mm CODE	WIDTH	H:720mm CODE	WIDTH																																																																																																									
RMWU60-7	600																																																																																																											

MEDIUM WALL TALL WALL

Bi-Fold	TALL WALL	Glazed Door	Diagonal Corner	Splayed	Boiler Wall	HORIZONTAL WALL																																																																																								
<table border="1"> <tr><th>H:720mm CODE</th><th>WIDTH</th><th>H:900mm CODE</th><th>WIDTH</th></tr> <tr><td>RBFU50-7</td><td>500</td><td>RBFU60-7</td><td>600</td></tr> <tr><td>RBFU80-7</td><td>800</td><td>RBFU90-7</td><td>900</td></tr> <tr><td>RBFU10-7</td><td>1000</td><td></td><td></td></tr> </table>	H:720mm CODE	WIDTH	H:900mm CODE	WIDTH	RBFU50-7	500	RBFU60-7	600	RBFU80-7	800	RBFU90-7	900	RBFU10-7	1000			<table border="1"> <tr><th>H:900mm CODE</th><th>WIDTH</th><th>H:900mm CODE</th><th>WIDTH</th></tr> <tr><td>RWU30-9</td><td>300</td><td>RWU40-9</td><td>400</td></tr> <tr><td>RWU45-9</td><td>450</td><td>RWU50-9</td><td>500</td></tr> <tr><td>RWU60-9</td><td>600</td><td></td><td></td></tr> </table>	H:900mm CODE	WIDTH	H:900mm CODE	WIDTH	RWU30-9	300	RWU40-9	400	RWU45-9	450	RWU50-9	500	RWU60-9	600			<table border="1"> <tr><th>H:900mm CODE</th><th>WIDTH</th><th>H:900mm CODE</th><th>WIDTH</th></tr> <tr><td>RWG50-9</td><td>500</td><td>RWG10-9</td><td>1000</td></tr> </table>	H:900mm CODE	WIDTH	H:900mm CODE	WIDTH	RWG50-9	500	RWG10-9	1000	<table border="1"> <tr><th>H:900mm CODE</th><th>WIDTH</th><th>H:900mm CODE</th><th>WIDTH</th></tr> <tr><td>RCWD60-9</td><td>600x600</td><td>RCWL60-9</td><td>600x600</td></tr> </table>	H:900mm CODE	WIDTH	H:900mm CODE	WIDTH	RCWD60-9	600x600	RCWL60-9	600x600	<table border="1"> <tr><th>H:900mm CODE</th><th>WIDTH</th><th>H:900mm CODE</th><th>WIDTH</th></tr> <tr><td>RAWU360-9</td><td>360</td><td>BWU6040-9</td><td>600</td></tr> </table>	H:900mm CODE	WIDTH	H:900mm CODE	WIDTH	RAWU360-9	360	BWU6040-9	600	<table border="1"> <tr><th>H:900mm CODE</th><th>WIDTH</th><th>H:900mm CODE</th><th>WIDTH</th></tr> <tr><td>RHWU5029</td><td>500</td><td>RHWU6029</td><td>600</td></tr> <tr><td>RHWU8029</td><td>800</td><td>RHWU9029</td><td>900</td></tr> <tr><td>RHWU1029</td><td>1000</td><td></td><td></td></tr> </table>	H:900mm CODE	WIDTH	H:900mm CODE	WIDTH	RHWU5029	500	RHWU6029	600	RHWU8029	800	RHWU9029	900	RHWU1029	1000			<table border="1"> <tr><th>H:290mm CODE</th><th>WIDTH</th><th>H:360mm CODE</th><th>WIDTH</th></tr> <tr><td>RHWU5029</td><td>500</td><td>RHWU6029</td><td>600</td></tr> <tr><td>RHWU8029</td><td>800</td><td>RHWU9029</td><td>900</td></tr> <tr><td>RHWU1029</td><td>1000</td><td></td><td></td></tr> </table>	H:290mm CODE	WIDTH	H:360mm CODE	WIDTH	RHWU5029	500	RHWU6029	600	RHWU8029	800	RHWU9029	900	RHWU1029	1000		
H:720mm CODE	WIDTH	H:900mm CODE	WIDTH																																																																																											
RBFU50-7	500	RBFU60-7	600																																																																																											
RBFU80-7	800	RBFU90-7	900																																																																																											
RBFU10-7	1000																																																																																													
H:900mm CODE	WIDTH	H:900mm CODE	WIDTH																																																																																											
RWU30-9	300	RWU40-9	400																																																																																											
RWU45-9	450	RWU50-9	500																																																																																											
RWU60-9	600																																																																																													
H:900mm CODE	WIDTH	H:900mm CODE	WIDTH																																																																																											
RWG50-9	500	RWG10-9	1000																																																																																											
H:900mm CODE	WIDTH	H:900mm CODE	WIDTH																																																																																											
RCWD60-9	600x600	RCWL60-9	600x600																																																																																											
H:900mm CODE	WIDTH	H:900mm CODE	WIDTH																																																																																											
RAWU360-9	360	BWU6040-9	600																																																																																											
H:900mm CODE	WIDTH	H:900mm CODE	WIDTH																																																																																											
RHWU5029	500	RHWU6029	600																																																																																											
RHWU8029	800	RHWU9029	900																																																																																											
RHWU1029	1000																																																																																													
H:290mm CODE	WIDTH	H:360mm CODE	WIDTH																																																																																											
RHWU5029	500	RHWU6029	600																																																																																											
RHWU8029	800	RHWU9029	900																																																																																											
RHWU1029	1000																																																																																													

GLAZED DRESSER OPEN WALL MIDI UNITS LARDER

GLAZED DRESSER	OPEN WALL	MIDI UNITS	LARDER																																												
<table border="1"> <tr><th>H:1210mm CODE</th><th>WIDTH</th></tr> <tr><td>RDR2/50</td><td>500</td></tr> </table>	H:1210mm CODE	WIDTH	RDR2/50	500	<table border="1"> <tr><th>H:290mm CODE</th><th>WIDTH</th></tr> <tr><td>RWOS50-2</td><td>500</td></tr> <tr><td>RWOS60-2</td><td>600</td></tr> <tr><td>RWOS80-2</td><td>800</td></tr> <tr><td>RWOS90-2</td><td>900</td></tr> <tr><td>RWOS10-2</td><td>1000</td></tr> </table>	H:290mm CODE	WIDTH	RWOS50-2	500	RWOS60-2	600	RWOS80-2	800	RWOS90-2	900	RWOS10-2	1000	<table border="1"> <tr><th>H:360mm CODE</th><th>WIDTH</th></tr> <tr><td>RWOS50-3</td><td>500</td></tr> <tr><td>RWOS60-3</td><td>600</td></tr> <tr><td>RWOS80-3</td><td>800</td></tr> <tr><td>RWOS10-3</td><td>1000</td></tr> </table>	H:360mm CODE	WIDTH	RWOS50-3	500	RWOS60-3	600	RWOS80-3	800	RWOS10-3	1000	<table border="1"> <tr><th>H:575mm CODE</th><th>WIDTH</th></tr> <tr><td>RWOS30-5</td><td>300</td></tr> <tr><td>RWOS40-5</td><td>400</td></tr> <tr><td>RWOS45-5</td><td>450</td></tr> <tr><td>RWOS50-5</td><td>500</td></tr> <tr><td>RWOS60-5</td><td>600</td></tr> <tr><td>RWOS80-5</td><td>800</td></tr> <tr><td>RWOS90-5</td><td>900</td></tr> <tr><td>RWOS10-5</td><td>1000</td></tr> </table>	H:575mm CODE	WIDTH	RWOS30-5	300	RWOS40-5	400	RWOS45-5	450	RWOS50-5	500	RWOS60-5	600	RWOS80-5	800	RWOS90-5	900	RWOS10-5	1000
H:1210mm CODE	WIDTH																																														
RDR2/50	500																																														
H:290mm CODE	WIDTH																																														
RWOS50-2	500																																														
RWOS60-2	600																																														
RWOS80-2	800																																														
RWOS90-2	900																																														
RWOS10-2	1000																																														
H:360mm CODE	WIDTH																																														
RWOS50-3	500																																														
RWOS60-3	600																																														
RWOS80-3	800																																														
RWOS10-3	1000																																														
H:575mm CODE	WIDTH																																														
RWOS30-5	300																																														
RWOS40-5	400																																														
RWOS45-5	450																																														
RWOS50-5	500																																														
RWOS60-5	600																																														
RWOS80-5	800																																														
RWOS90-5	900																																														
RWOS10-5	1000																																														

LARDER PULL-OUT LARDER INNER DRAWER LARDER

LARDER	PULL-OUT LARDER	INNER DRAWER LARDER																												
<table border="1"> <tr><th>H:2150mm CODE</th><th>WIDTH</th></tr> <tr><td>RELU30</td><td>300</td></tr> <tr><td>RELU40</td><td>400</td></tr> <tr><td>RELU50</td><td>500</td></tr> <tr><td>RELU60</td><td>600</td></tr> <tr><td>ETLU80</td><td>800</td></tr> <tr><td>ETLU10</td><td>1000</td></tr> <tr><td>RELU60/1*</td><td>600</td></tr> </table>	H:2150mm CODE	WIDTH	RELU30	300	RELU40	400	RELU50	500	RELU60	600	ETLU80	800	ETLU10	1000	RELU60/1*	600	<table border="1"> <tr><th>H:1970mm CODE</th><th>WIDTH</th></tr> <tr><td>TDLU80</td><td>800</td></tr> <tr><td>TDLU10</td><td>1000</td></tr> </table>	H:1970mm CODE	WIDTH	TDLU80	800	TDLU10	1000	<table border="1"> <tr><th>H:1970mm CODE</th><th>WIDTH</th></tr> <tr><td>TCLU98</td><td>985x985</td></tr> <tr><td>ETCLU98*</td><td>985x985</td></tr> </table>	H:1970mm CODE	WIDTH	TCLU98	985x985	ETCLU98*	985x985
H:2150mm CODE	WIDTH																													
RELU30	300																													
RELU40	400																													
RELU50	500																													
RELU60	600																													
ETLU80	800																													
ETLU10	1000																													
RELU60/1*	600																													
H:1970mm CODE	WIDTH																													
TDLU80	800																													
TDLU10	1000																													
H:1970mm CODE	WIDTH																													
TCLU98	985x985																													
ETCLU98*	985x985																													

DOUBLE OVEN SINGLE OVEN SINGLE OVEN + COMPACT COMPACT TALL FRIDGE/FREEZER BOX WINE RACKS END SUPPORT PANELS

DOUBLE OVEN	SINGLE OVEN	SINGLE OVEN + COMPACT	COMPACT	TALL FRIDGE/FREEZER	BOX WINE RACKS	END SUPPORT PANELS																																																																																			
<table border="1"> <tr><th>H:1970mm CODE</th><th>WIDTH</th></tr> <tr><td>RTOHD60</td><td>600</td></tr> <tr><td>RETODD60</td><td>600</td></tr> <tr><td>RETOHDD60*</td><td>600</td></tr> </table>	H:1970mm CODE	WIDTH	RTOHD60	600	RETODD60	600	RETOHDD60*	600	<table border="1"> <tr><th>H:1970mm CODE</th><th>WIDTH</th></tr> <tr><td>RTOHS60</td><td>600</td></tr> <tr><td>RETOHSD60</td><td>600</td></tr> <tr><td>RETOHS60*</td><td>600</td></tr> </table>	H:1970mm CODE	WIDTH	RTOHS60	600	RETOHSD60	600	RETOHS60*	600	<table border="1"> <tr><th>H:1970mm CODE</th><th>WIDTH</th></tr> <tr><td>RTOHC60</td><td>600</td></tr> <tr><td>RETOHSC60*</td><td>600</td></tr> </table>	H:1970mm CODE	WIDTH	RTOHC60	600	RETOHSC60*	600	<table border="1"> <tr><th>H:1970mm CODE</th><th>WIDTH</th></tr> <tr><td>RTOHC60</td><td>600</td></tr> <tr><td>RETOHSC60*</td><td>600</td></tr> </table>	H:1970mm CODE	WIDTH	RTOHC60	600	RETOHSC60*	600	<table border="1"> <tr><th>H:1970mm CODE</th><th>WIDTH</th></tr> <tr><td>RTFF1/60</td><td>600</td></tr> <tr><td>RTFF2/60</td><td>600</td></tr> <tr><td>RTFF3/60*</td><td>600</td></tr> <tr><td>RTFF4/60*</td><td>600</td></tr> <tr><td>RTFF1U/60*</td><td>600</td></tr> <tr><td>RTFF2U/60*</td><td>600</td></tr> <tr><td>RTFF3U/60*</td><td>600</td></tr> <tr><td>RTFF4U/60*</td><td>600</td></tr> </table>	H:1970mm CODE	WIDTH	RTFF1/60	600	RTFF2/60	600	RTFF3/60*	600	RTFF4/60*	600	RTFF1U/60*	600	RTFF2U/60*	600	RTFF3U/60*	600	RTFF4U/60*	600	<table border="1"> <tr><th>H:2150mm CODE</th><th>WIDTH</th></tr> <tr><td>RETFF1/60</td><td>600</td></tr> <tr><td>RETFF2/60</td><td>600</td></tr> <tr><td>RETFF3/60*</td><td>600</td></tr> <tr><td>RETFF4/60*</td><td>600</td></tr> <tr><td>RETFF1U/60*</td><td>600</td></tr> <tr><td>RETFF2U/60*</td><td>600</td></tr> <tr><td>RETFF3U/60*</td><td>600</td></tr> <tr><td>RETFF4U/60*</td><td>600</td></tr> </table>	H:2150mm CODE	WIDTH	RETFF1/60	600	RETFF2/60	600	RETFF3/60*	600	RETFF4/60*	600	RETFF1U/60*	600	RETFF2U/60*	600	RETFF3U/60*	600	RETFF4U/60*	600	<table border="1"> <tr><th>W:125mm / W:250mm* CODE</th><th>HEIGHT</th></tr> <tr><td>RWR125-7*</td><td>720</td></tr> <tr><td>RWR125-9</td><td>900</td></tr> <tr><td>RWR125-9*</td><td>900</td></tr> <tr><td>WR125-1210</td><td>1210</td></tr> <tr><td>WR125-1970</td><td>1970</td></tr> </table>	W:125mm / W:250mm* CODE	HEIGHT	RWR125-7*	720	RWR125-9	900	RWR125-9*	900	WR125-1210	1210	WR125-1970	1970	<table border="1"> <tr><th>H:900mm CODE</th><th>WIDTH</th></tr> <tr><td>ESP</td><td>600</td></tr> <tr><td>900/700</td><td>700</td></tr> </table>	H:900mm CODE	WIDTH	ESP	600	900/700	700
H:1970mm CODE	WIDTH																																																																																								
RTOHD60	600																																																																																								
RETODD60	600																																																																																								
RETOHDD60*	600																																																																																								
H:1970mm CODE	WIDTH																																																																																								
RTOHS60	600																																																																																								
RETOHSD60	600																																																																																								
RETOHS60*	600																																																																																								
H:1970mm CODE	WIDTH																																																																																								
RTOHC60	600																																																																																								
RETOHSC60*	600																																																																																								
H:1970mm CODE	WIDTH																																																																																								
RTOHC60	600																																																																																								
RETOHSC60*	600																																																																																								
H:1970mm CODE	WIDTH																																																																																								
RTFF1/60	600																																																																																								
RTFF2/60	600																																																																																								
RTFF3/60*	600																																																																																								
RTFF4/60*	600																																																																																								
RTFF1U/60*	600																																																																																								
RTFF2U/60*	600																																																																																								
RTFF3U/60*	600																																																																																								
RTFF4U/60*	600																																																																																								
H:2150mm CODE	WIDTH																																																																																								
RETFF1/60	600																																																																																								
RETFF2/60	600																																																																																								
RETFF3/60*	600																																																																																								
RETFF4/60*	600																																																																																								
RETFF1U/60*	600																																																																																								
RETFF2U/60*	600																																																																																								
RETFF3U/60*	600																																																																																								
RETFF4U/60*	600																																																																																								
W:125mm / W:250mm* CODE	HEIGHT																																																																																								
RWR125-7*	720																																																																																								
RWR125-9	900																																																																																								
RWR125-9*	900																																																																																								
WR125-1210	1210																																																																																								
WR125-1970	1970																																																																																								
H:900mm CODE	WIDTH																																																																																								
ESP	600																																																																																								
900/700	700																																																																																								

CARCASE MFC PANELS WALL CANOPIES CORNICE LIGHT PELMET PLINTH

CARCASE MFC PANELS	WALL CANOPIES	CORNICE	LIGHT PELMET	PLINTH																																		
<table border="1"> <tr><th>CODE</th><th>WXH</th></tr> <tr><td>1970/300</td><td>300x1970</td></tr> <tr><td>2150/560</td><td>560x2150</td></tr> <tr><td>2350/660</td><td>660x2350</td></tr> <tr><td>720/300</td><td>300x720</td></tr> <tr><td>900/2000</td><td>2000x900</td></tr> <tr><td>900/300</td><td>300x900</td></tr> </table>	CODE	WXH	1970/300	300x1970	2150/560	560x2150	2350/660	660x2350	720/300	300x720	900/2000	2000x900	900/300	300x900	<table border="1"> <tr><th>H:705mm CODE</th><th>WIDTH</th></tr> <tr><td>EX100/705U</td><td>1000</td></tr> </table>	H:705mm CODE	WIDTH	EX100/705U	1000	<table border="1"> <tr><th>CODE</th><th>WIDTH</th></tr> <tr><td>CCOS/U</td><td>430x430</td></tr> </table>	CODE	WIDTH	CCOS/U	430x430	<table border="1"> <tr><th>H:55mm CODE</th><th>WIDTH</th></tr> <tr><td>CLPS/U</td><td>430x430</td></tr> </table>	H:55mm CODE	WIDTH	CLPS/U	430x430	<table border="1"> <tr><th>H:150mm CODE</th><th>WIDTH</th></tr> <tr><td>PL</td><td>2940</td></tr> <tr><td>PL/MOD900</td><td>900</td></tr> <tr><td>PL/U</td><td>3000</td></tr> </table>	H:150mm CODE	WIDTH	PL	2940	PL/MOD900	900	PL/U	3000
CODE	WXH																																					
1970/300	300x1970																																					
2150/560	560x2150																																					
2350/660	660x2350																																					
720/300	300x720																																					
900/2000	2000x900																																					
900/300	300x900																																					
H:705mm CODE	WIDTH																																					
EX100/705U	1000																																					
CODE	WIDTH																																					
CCOS/U	430x430																																					
H:55mm CODE	WIDTH																																					
CLPS/U	430x430																																					
H:150mm CODE	WIDTH																																					
PL	2940																																					
PL/MOD900	900																																					
PL/U	3000																																					

PLINTH PLANT ON END PANELS 18mm Tongue & Grooved 18mm Plain PILASTERS FURNITURE ACCS.

PLINTH	PLANT ON END PANELS	18mm Tongue & Grooved	18mm Plain	PILASTERS	FURNITURE ACCS.																																				
<table border="1"> <tr><th>H:20mm CODE</th><th>WIDTH</th></tr> <tr><td>UPR/U</td><td>3000</td></tr> </table>	H:20mm CODE	WIDTH	UPR/U	3000	<table border="1"> <tr><th>CODE</th><th>WXH</th></tr> <tr><td>2430/650T/18</td><td>650x2430</td></tr> <tr><td>900/650P/18U</td><td>650x900</td></tr> <tr><td>960/360T/18</td><td>360x960</td></tr> </table>	CODE	WXH	2430/650T/18	650x2430	900/650P/18U	650x900	960/360T/18	360x960	<table border="1"> <tr><th>CODE</th><th>WXH</th></tr> <tr><td>2430/650P/18U</td><td>650x900</td></tr> <tr><td>960/360P/18U</td><td>360x960</td></tr> </table>	CODE	WXH	2430/650P/18U	650x900	960/360P/18U	360x960	<table border="1"> <tr><th>CODE</th><th>WXH</th></tr> <tr><td>900/1200T/18U</td><td>1200x900</td></tr> <tr><td>910/2450T/18U</td><td>2450x910</td></tr> </table>	CODE	WXH	900/1200T/18U	1200x900	910/2450T/18U	2450x910	<table border="1"> <tr><th>CODE</th><th>HEIGHT</th></tr> <tr><td>PIL/MOD2400</td><td>2400</td></tr> <tr><td>PIL/MOD900</td><td>900</td></tr> <tr><td>PILBEAD*</td><td>900</td></tr> </table>	CODE	HEIGHT	PIL/MOD2400	2400	PIL/MOD900	900	PILBEAD*	900	<table border="1"> <tr><th>CODE</th><th>WIDTH</th></tr> <tr><td>CP/UL</td><td>146</td></tr> </table>	CODE	WIDTH	CP/UL	146
H:20mm CODE	WIDTH																																								
UPR/U	3000																																								
CODE	WXH																																								
2430/650T/18	650x2430																																								
900/650P/18U	650x900																																								
960/360T/18	360x960																																								
CODE	WXH																																								
2430/650P/18U	650x900																																								
960/360P/18U	360x960																																								
CODE	WXH																																								
900/1200T/18U	1200x900																																								
910/2450T/18U	2450x910																																								
CODE	HEIGHT																																								
PIL/MOD2400	2400																																								
PIL/MOD900	900																																								
PILBEAD*	900																																								
CODE	WIDTH																																								
CP/UL	146																																								

FURNITURE ACCESSORIES INTEGRATED DOORS WINE CAB DOORS SPARE DOOR FITTINGS GENERAL ACCS.

FURNITURE ACCESSORIES	INTEGRATED DOORS	WINE CAB DOORS	SPARE DOOR FITTINGS	GENERAL ACCS.																												
<table border="1"> <tr><th>CODE</th><th>WIDTH</th></tr> <tr><td>BSLATS/UOA</td><td>12</td></tr> </table>	CODE	WIDTH	BSLATS/UOA	12	<table border="1"> <tr><th>H:3000mm CODE</th><th>WIDTH</th></tr> <tr><td>RP/U</td><td>50</td></tr> </table>	H:3000mm CODE	WIDTH	RP/U	50	<table border="1"> <tr><th>H:28mm CODE</th><th>WXD</th></tr> <tr><td>RPCMC/U</td><td>52x52</td></tr> </table>	H:28mm CODE	WXD	RPCMC/U	52x52	<table border="1"> <tr><th>CODE</th><th>WXH</th></tr> <tr><td>INT4571</td><td>446x715</td></tr> <tr><td>INT6071</td><td>596x715</td></tr> </table>	CODE	WXH	INT4571	446x715	INT6071	596x715	<table border="1"> <tr><th>CODE</th><th>HEIGHT</th></tr> <tr><td>STPWN</td><td>Set of 2</td></tr> <tr><td>LEGSET</td><td>Set of 4</td></tr> <tr><td>SACC</td><td>Pk 50</td></tr> <tr><td>TOUCH/U</td><td>1ltr</td></tr> </table>	CODE	HEIGHT	STPWN	Set of 2	LEGSET	Set of 4	SACC	Pk 50	TOUCH/U	1ltr
CODE	WIDTH																															
BSLATS/UOA	12																															
H:3000mm CODE	WIDTH																															
RP/U	50																															
H:28mm CODE	WXD																															
RPCMC/U	52x52																															
CODE	WXH																															
INT4571	446x715																															
INT6071	596x715																															
CODE	HEIGHT																															
STPWN	Set of 2																															
LEGSET	Set of 4																															
SACC	Pk 50																															
TOUCH/U	1ltr																															

Note: Furniture codes beginning with the letter 'R' are assembled (rigid), by removing the 'R' the units are supplied unassembled (flat-pack).

Note: Furniture codes beginning with the letter 'R' are assembled (rigid), by removing the 'R' the units are supplied unassembled (flat-pack).



SHAKER  
PRICE GROUP 4  
**NOVARA**

Colours Options [PG4]: Hunter, Light Grey, Porcelain and Storm.



HI-LINE BASE | LOW BASE | HI-LINE CORNER BASE | 'L' Shaped

HI-LINE BASE		LOW BASE		HI-LINE CORNER BASE		'L' Shaped					
CODE	WIDTH	CODE	WIDTH	CODE	WIDTH	CODE	WIDTH				
RBA15	150	RBA30	300	RBA35	350	RBA45	450	RBA50	500	RBA60	600
RBA15	150	RBA30	300	RBA35	350	RBA45	450	RBA50	500	RBA60	600
RBA15	150	RBA30	300	RBA35	350	RBA45	450	RBA50	500	RBA60	600

HI-LINE CORNER BASE | DRAWERLINE BASE | DRAWERLINE SINK BASE CERAMIC SINK BASE | DRAWERLINE CORNER | BUILT UNDER

HI-LINE CORNER BASE		DRAWERLINE BASE		DRAWERLINE SINK BASE CERAMIC SINK BASE		DRAWERLINE CORNER		BUILT UNDER	
CODE	WIDTH	CODE	WIDTH	CODE	WIDTH	CODE	WIDTH	CODE	WIDTH
RBA360	360	RBD30	300	RBD40	400	RBD45	450	RBD50	500
RBA360	360	RBD30	300	RBD40	400	RBD45	450	RBD50	500
RBA360	360	RBD30	300	RBD40	400	RBD45	450	RBD50	500

2 DRAWER BASE | 3 DRAWER BASE | 4 DRAWER BASE | 5 DRAWER BASE | LOW WALL

2 DRAWER BASE		3 DRAWER BASE		4 DRAWER BASE		5 DRAWER BASE		LOW WALL	
CODE	WIDTH	CODE	WIDTH	CODE	WIDTH	CODE	WIDTH	CODE	WIDTH
RBD250	500	RBD260	600	RBD280	800	RBD290	900	RBD210	1000
RBD250	500	RBD260	600	RBD280	800	RBD290	900	RBD210	1000
RBD250	500	RBD260	600	RBD280	800	RBD290	900	RBD210	1000

LOW WALL | MEDIUM WALL

LOW WALL		MEDIUM WALL	
CODE	WIDTH	CODE	WIDTH
RWU30-7	300	RWU35-7	350
RWU30-7	300	RWU35-7	350
RWU30-7	300	RWU35-7	350

MEDIUM WALL | TALL WALL

MEDIUM WALL		TALL WALL	
CODE	WIDTH	CODE	WIDTH
RBFU10-7	1000	RWU30-9	300
RBFU10-7	1000	RWU30-9	300
RBFU10-7	1000	RWU30-9	300

TALL WALL | HORIZONTAL WALL | OPEN WALL

TALL WALL		HORIZONTAL WALL		OPEN WALL	
CODE	WIDTH	CODE	WIDTH	CODE	WIDTH
BWU6040-9	600	RHWU5029	500	RWOS50-2	500
BWU6040-9	600	RHWU5029	500	RWOS50-2	500
BWU6040-9	600	RHWU5029	500	RWOS50-2	500

OPEN WALL | MIDI UNITS | LARDER

OPEN WALL		MIDI UNITS		LARDER	
CODE	WIDTH	CODE	WIDTH	CODE	WIDTH
RDC1/50	500	RMLU60	600	RTL30	300
RDC1/50	500	RMLU60	600	RTL30	300
RDC1/50	500	RMLU60	600	RTL30	300

PULL-OUT LARDER | INNER DRAWER LARDER | DOUBLE OVEN | SINGLE OVEN | SINGLE OVEN + COMPACT | COMPACT | TALL FRIDGE/FREEZER

PULL-OUT LARDER		INNER DRAWER LARDER		DOUBLE OVEN		SINGLE OVEN		SINGLE OVEN + COMPACT		COMPACT		TALL FRIDGE/FREEZER	
CODE	WIDTH	CODE	WIDTH	CODE	WIDTH	CODE	WIDTH	CODE	WIDTH	CODE	WIDTH	CODE	WIDTH
RTISPOL30	300	RTLID30	300	RTOHD60	600	RTOHS60	600	RTOHSC60	600	RTOHC60	600	RTFF1/60	600
RTISPOL30	300	RTLID30	300	RTOHD60	600	RTOHS60	600	RTOHSC60	600	RTOHC60	600	RTFF1/60	600
RTISPOL30	300	RTLID30	300	RTOHD60	600	RTOHS60	600	RTOHSC60	600	RTOHC60	600	RTFF1/60	600

TALL FRIDGE/FREEZER | BOX WINE RACKS | END SUPPORT PANELS | CARCASE MFC PANELS | CORNICE + PELMET | PLINTH

TALL FRIDGE/FREEZER		BOX WINE RACKS		END SUPPORT PANELS		CARCASE MFC PANELS		CORNICE + PELMET		PLINTH	
CODE	WIDTH	CODE	WIDTH	CODE	WIDTH	CODE	WIDTH	CODE	WIDTH	CODE	WIDTH
RETFF1/60	600	RWR125-7	720	ESP	600	1970/300	300x1970	CO/U4	3000	PL/U4	3000
RETFF1/60	600	RWR125-7	720	ESP	600	1970/300	300x1970	CO/U4	3000	PL/U4	3000
RETFF1/60	600	RWR125-7	720	ESP	600	1970/300	300x1970	CO/U4	3000	PL/U4	3000

PLANT ON END PANELS | PILASTERS | FURNITURE ACCESSORIES

PLANT ON END PANELS		PILASTERS		FURNITURE ACCESSORIES	
CODE	WIDTH	CODE	WIDTH	CODE	WIDTH
2430/650P/18U4	650x2430	PIL/MOD900U4	75	CP/U4	146
2430/650P/18U4	650x2430	PIL/MOD900U4	75	CP/U4	146
2430/650P/18U4	650x2430	PIL/MOD900U4	75	CP/U4	146

FURNITURE ACCESSORIES | INTEGRATED DOORS | SPARE DOOR FITTINGS | GENERAL ACCS.

FURNITURE ACCESSORIES		INTEGRATED DOORS		SPARE DOOR FITTINGS		GENERAL ACCS.	
CODE	WIDTH	CODE	WIDTH	CODE	WIDTH	CODE	WIDTH
BSLATS/UOA	82x460	INT4571	446x715	STPW	Set of 2	LEGSET	Set of 4
BSLATS/UOA	82x460	INT4571	446x715	STPW	Set of 2	LEGSET	Set of 4
BSLATS/UOA	82x460	INT4571	446x715	STPW	Set of 2	LEGSET	Set of 4

Note: Furniture codes beginning with the letter 'R' are assembled (rigid), by removing the 'R' the units are supplied unassembled (flat-pack).

Note: Furniture codes beginning with the letter 'R' are assembled (rigid), by removing the 'R' the units are supplied unassembled (flat-pack).

SHAKER  
PRICE GROUP 3  
**OATEN**

Special sizes available  
contact us for further information

Colours Options [PG3]: Cashmere, Dust Grey, Graphite, Indigo, Light Grey and Porcelain.



HI-LINE BASE LOW BASE HI-LINE CORNER BASE 'L' Shaped

HI-LINE BASE	LOW BASE	HI-LINE CORNER BASE	'L' Shaped
<p>H:720mm CODE WIDTH <b>RBISPO15</b> 150 Standard Mechanism inc. <b>RBKPO15</b> 150 Kesseböhmer Mechanism inc. <b>RBKTP015</b> 150 Kesseböhmer Mechanism &amp; Towel rail inc.</p>	<p>H:720mm CODE WIDTH <b>RBU30</b> 300 <b>RBU35</b> 350 <b>RBU40</b> 400 <b>RBU45</b> 450 <b>RBU50</b> 500 <b>RBU60</b> 600 <b>RBU70</b> 700 <b>RBU80</b> 800 <b>RBU90</b> 900 <b>RBU10</b> 1000 # 2 x Doors</p>	<p>H:720mm CODE WIDTH <b>RBAC830</b> 800/300 <b>RBAC80</b> 800/400 <b>RBAC845</b> 800/450 <b>RBAC850</b> 800/500 <b>RBAC860</b> 800/600 <b>RBAC940</b> 900/400 <b>RBAC945</b> 900/450</p>	<p>H:720mm CODE WIDTH <b>BAC90</b> 900x900 Bi-fold hinge system Flat pack</p>

HI-LINE CORNER BASE DRAWERLINE BASE DRAWERLINE SINK BASE CERAMIC SINK BASE DRAWERLINE CORNER BUILT UNDER 2 DRAWER BASE

HI-LINE CORNER BASE	DRAWERLINE BASE	DRAWERLINE SINK BASE	CERAMIC SINK BASE	DRAWERLINE CORNER	BUILT UNDER	2 DRAWER BASE
<p>H:720mm CODE WIDTH <b>CDA90</b> 900x900 Flat pack</p>	<p>H:720mm CODE WIDTH <b>RBD30</b> 300 <b>RBD40</b> 400 <b>RBD45</b> 450 <b>RBD50</b> 500 <b>RBD60</b> 600 <b>RBD80</b> 800 <b>RBD90</b> 900 <b>RBD10</b> 1000 <b>RBD12</b> 1200 # 2 x Doors</p>	<p>H:720mm CODE WIDTH <b>RBD80/1</b> 800 <b>RBD90/1</b> 900 <b>RBD10/1</b> 1000</p>	<p>H:720mm CODE WIDTH <b>RBDF50</b> 500 <b>RBDF60</b> 600 <b>RBDF80</b> 800 <b>RBDF90</b> 900 <b>RBDF10</b> 1000 <b>RBD10*</b> 1000 <b>RBD12*</b> 1200 *One working drawer # 2 x Doors</p>	<p>H:720mm CODE WIDTH <b>RBDC830</b> 800/300 <b>RBDC80</b> 800/400 <b>RBDC845</b> 800/450 <b>RBDC850</b> 800/500 <b>RBDC860</b> 800/600 <b>RBDC140</b> 1000/400 <b>RBDC145</b> 1000/450 <b>RBDC10</b> 1000/500 <b>RBDC160</b> 1000/600 <b>RBDC12</b> 1200/600 Inc. Corner Post &amp; Blanking Panel</p>	<p>H:720mm CODE WIDTH <b>RBU060</b> 600 175mm drawer &amp; 110mm filler</p>	<p>H:720mm CODE WIDTH <b>RBD250</b> 500 <b>RBD260</b> 600 <b>RBD280</b> 800 <b>RBD290</b> 900 <b>RBD210</b> 1000 2x355mm Drawers</p>

3 DRAWER BASE 4 DRAWER BASE 5 DRAWER BASE LOW WALL MEDIUM WALL

3 DRAWER BASE	4 DRAWER BASE	5 DRAWER BASE	LOW WALL	MEDIUM WALL
<p>H:720mm CODE WIDTH <b>RBD350</b> 500 <b>RBD360</b> 600 <b>RBD380</b> 800 <b>RBD390</b> 900 <b>RBD310</b> 1000 1x140mm, 2x283mm Drawers</p>	<p>H:720mm CODE WIDTH <b>RBD450</b> 500 <b>RBD460</b> 600 <b>RBD480</b> 800 <b>RBD490</b> 900 <b>RBD410</b> 1000 3x140mm, 1x283mm Drawers</p>	<p>H:720mm CODE WIDTH <b>RBD530</b> 300 <b>RBD540</b> 400 <b>RBD545</b> 450 <b>RBD550</b> 500 <b>RBD560</b> 600 <b>RBD580</b> 800 <b>RBD590</b> 900 <b>RBD510</b> 1000 5x140mm Drawers</p>	<p>H:575mm CODE WIDTH <b>RWU30-5</b> 300 <b>RWU40-5</b> 400 <b>RWU45-5</b> 450 <b>RWU50-5</b> 500 <b>RWU60-5</b> 600 Add 'X' to the end of the code for 350mm deep</p>	<p>H:720mm CODE WIDTH <b>RWU30-7</b> 300 <b>RWU35-7</b> 350 <b>RWU40-7</b> 400 <b>RWU45-7</b> 450 <b>RWU50-7</b> 500 <b>RWU60-7</b> 600 Add 'X' to the end of the code for 350mm deep</p>

Glazed Door Diagonal Corner 'L' Shaped Corner Conventional Corner Splayed Microwave Wall Bi-Fold

Glazed Door	Diagonal Corner	'L' Shaped Corner	Conventional Corner	Splayed	Microwave Wall	Bi-Fold
<p>H:720mm CODE WIDTH <b>RWG50-7*</b> 500 <b>RWG10-7*</b> 1000 Add 'X' to the end of the code for 350mm deep</p>	<p>H:720mm CODE WIDTH <b>RCWD60-7</b> 600x600 Add 'X' to the end of the code for 350mm deep [650x650]</p>	<p>H:720mm CODE WIDTH <b>RCWL60-7</b> 600x600 Bi-fold hinge system Add 'X' to the end of the code for 350mm deep</p>	<p>H:720mm CODE WIDTH <b>RWUC60-7</b> 600 Inc. Corner Post Add 'X' to the end of the code for 350mm deep</p>	<p>H:720mm CODE WIDTH <b>RAWU360-7</b> 360 Add 'X' to the end of the code for 350mm deep</p>	<p>H:720mm CODE WIDTH <b>RMWU60-7</b> 600 283mm flap, 110mm filler, Mechanism inc. Add 'X' to the end of the code for 350mm deep</p>	<p>H:720mm CODE WIDTH <b>RFWU50-7</b> 500 <b>RFWU60-7</b> 600 <b>RFWU80-7</b> 800 <b>RFWU90-7</b> 900 <b>RFWU10-7</b> 1000 Mechanism inc. Add 'X' to the end of the code for 350mm deep</p>

Note: Furniture codes beginning with the letter 'R' are assembled (rigid), by removing the 'R' the units are supplied unassembled (flat-pack).

TALL WALL

Glazed Door	Feature Door	Diagonal Corner	Splayed	Boiler Wall
<p>H:900mm CODE WIDTH <b>RWU30-9</b> 300 <b>RWU40-9</b> 400 <b>RWU45-9</b> 450 <b>RWU50-9</b> 500 <b>RWU60-9</b> 600</p>	<p>H:900mm CODE WIDTH <b>RWG50-9*</b> 500 <b>RWG10-9*</b> 1000 Add 'X' to the end of the code for 350mm deep</p>	<p>H:900mm CODE WIDTH <b>RCWD60-9</b> 600x600 Add 'X' to the end of the code for 350mm deep [650x650]</p>	<p>H:900mm CODE WIDTH <b>RAWU360-9</b> 360 Add 'X' to the end of the code for 350mm deep</p>	<p>H:900mm CODE WIDTH <b>BWU6040-9</b> 600 400mm Deep Flat pack</p>

HORIZONTAL WALL OPEN WALL

HORIZONTAL WALL	OPEN WALL
<p>H:290mm CODE WIDTH <b>RHWU5029</b> 500 <b>RHWU6029</b> 600 <b>RHWU8029</b> 800 <b>RHWU9029</b> 900 <b>RHWU1029</b> 1000 <b>RHWU5036*</b> 600 <b>RHWU6036*</b> 600 <b>RHWU8036*</b> 800 <b>RHWU9036*</b> 800 <b>RHWU1036*</b> 1000 Add 'X' to the end of the code for 350mm deep</p>	<p>H:290mm CODE WIDTH <b>RWOS50-2</b> 500 <b>RWOS60-2</b> 600 <b>RWOS80-2</b> 800 <b>RWOS90-2</b> 900 <b>RWOS10-2</b> 1000 MFC Carcase If 350mm deep carcase is required adjust code, e.g. RWOS1035-2</p>

MIDI UNITS LARDER

MIDI UNITS	LARDER
<p>H:1250mm CODE WIDTH <b>RMLU60</b> 600 <b>RMA160</b> 600</p>	<p>H:1970mm CODE WIDTH <b>RTLU30</b> 300 <b>RTLU40</b> 400 <b>RTLU50</b> 500 <b>RTLU60</b> 600 <b>TLU80</b> 800 <b>TLU10</b> 1000</p>

PULL-OUT LARDER INNER DRAWER LARDER DOUBLE OVEN SINGLE OVEN SINGLE OVEN + COMPACT COMPACT TALL FRIDGE/FREEZER

PULL-OUT LARDER	INNER DRAWER LARDER	DOUBLE OVEN	SINGLE OVEN	SINGLE OVEN + COMPACT	COMPACT	TALL FRIDGE/FREEZER
<p>H:1970mm CODE WIDTH <b>RTISPOL30</b> 300 <b>RTKPOL30</b> 300 Standard Mechanism inc. <b>RETISPOL30*</b> 300 <b>RETKPOL30*</b> 300 Kesseböhmer Mechanism inc.</p>	<p>H:1970mm CODE WIDTH <b>RTLID30</b> 300 <b>RTLID40</b> 400 <b>RTLID50</b> 500 <b>RTLID60</b> 600 1 x Standard, 4 x Deep drawers</p>	<p>H:1970mm CODE WIDTH <b>RTOHD60</b> 600 <b>RTOHD60*</b> 600</p>	<p>H:1970mm CODE WIDTH <b>RTOHS60</b> 600 <b>RTOHS60*</b> 600</p>	<p>H:1970mm CODE WIDTH <b>RTOHC60</b> 600 <b>RETOHC60*</b> 600</p>	<p>H:1970mm CODE WIDTH <b>RTOHC60</b> 600</p>	<p>H:1970mm CODE WIDTH <b>RTFF1/60</b> 600 <b>RTFF4/60*</b> 600 *Doors undrilled <b>RTFFU/60</b> 600 <b>RTFFU/60*</b> 600 # For door on door appliances</p>

TALL FRIDGE/FREEZER BOX WINE RACKS END SUPPORT PANELS CARCASE MFC PANELS CORNICE + PELMET PLINTH

TALL FRIDGE/FREEZER	BOX WINE RACKS	END SUPPORT PANELS	CARCASE MFC PANELS	CORNICE + PELMET	PLINTH
<p>H:2150mm CODE WIDTH <b>RTFF1/60</b> 600 <b>RTFF2/60</b> 600 <b>RTFF3/60*</b> 600 <b>RTFF1U/60</b> 600 <b>RTFF2U/60</b> 600 <b>RTFF3U/60*</b> 600 # For door on door appliances *715mm bottom, 1425mm top door</p>	<p>W:125mm / W:250mm* CODE HEIGHT <b>RWR125-7</b> 720 <b>RWR250-7*</b> 720 <b>RWR125-9</b> 900 <b>RWR250-9*</b> 900 <b>RWR125-1210</b> 1210 <b>WR125-1970</b> 1970 <b>WR250-1970</b> 1970 MFC Carcase If using as base order LEGSET</p>	<p>H:900mm CODE WIDTH <b>ESP</b> 600 <b>900/700</b> 700 MFC Carcase</p>	<p>H:1970mm CODE WIDTH <b>1970/300</b> 300x1970 <b>2150/560</b> 560x2150 <b>2350/660</b> 660x2350 <b>720/300</b> 300x720 <b>900/2000</b> 2000x900 <b>900/300</b> 300x900 MFC Carcase</p>	<p>H:65mm CODE WIDTH <b>CO/U2</b> 3000</p>	<p>H:150mm CODE WIDTH <b>PL</b> 2940 MFC Carcase <b>PL/U2</b> 3000 Door Finish</p>

PLINTH PLANT ON END PANELS FURNITURE ACCESSORIES INTEGRATED DOORS SPARE DOOR FITTINGS GENERAL ACCS.

PLINTH	PLANT ON END PANELS	FURNITURE ACCESSORIES	INTEGRATED DOORS	SPARE DOOR FITTINGS	GENERAL ACCS.
<p>Clear Sealing Strip CODE WIDTH <b>PST</b> 3000</p>	<p>CODE WXH <b>2430/650/18U2</b> 650x2430 <b>900/650/18U2</b> 650x900 <b>960/360P/18U2</b> 360x960 <b>910/2430/18U2</b> 2430x910 Door Finish</p>	<p>H:715mm CODE WIDTH <b>CP/U2</b> 146 Flat Panel for on site conversion Door Finish</p>	<p>Undrilled CODE WXH <b>INT4571</b> 446x715 <b>INT6071</b> 596x715</p>	<p>Hinges [Hettich Soft Close] CODE <b>SCHINGE90</b> 90 degree [Pair] <b>SCHINGE170</b> 170 degree [Pair]</p>	<p>Stays [Blum Aventos] CODE <b>BLSTAYHKS</b> HK-S stay [Pair] * [inc mounting brackets]</p>

Note: Furniture codes beginning with the letter 'R' are assembled (rigid), by removing the 'R' the units are supplied unassembled (flat-pack).



SHAKER  
PRICE GROUP 2  
**PENSFORD**

Special sizes available  
contact us for further information

Colours Options [PG 2]: Anthracite, Black, Blush, Cashmere, Dust, Fern, Fjord, Grey, Hunter, Indigo, Mussel, Navy, Porcelain, Terracotta and White.



**HI-LINE BASE** Pull-Out Curved Door Splayed Curved Return [300mm deep] Shallow Base [300mm deep] **LOW BASE**

H:720mm	WIDTH	CODE	WIDTH	H:720mm	WIDTH	H:720mm	WIDTH	H:720mm	WIDTH	H:720mm	WIDTH	H:720mm	WIDTH	H:720mm	WIDTH	H:575mm	WIDTH
RBA15	150	R2BA60*	600	RBISPO15	150	RCDBA30	300x300	RABA360	360	RCRBA26	260	RSBU30	300	RSBU70*	700	RLBU30	300
RBA26	260	RBA70*	700	Standard Mechanism inc.				RSBU35	350	RSBU80*	800	RLBU40	400	RSBU80*	800	RLBU40	400
RBA30	300	RBA80*	800	RBKPO15	150			RSBU40	400	RSBU90*	900	RLBU45	450	RSBU90*	900	RLBU45	450
RBA35	350	RBA90*	900	Kesseböhmer Mechanism inc.				RSBU45	450	RSBU10*	1000	RLBU50	500	RSBU10*	1000	RLBU50	500
RBA40	400	RBA10*	1000	RBKTP015	150			RSBU50	500	# 2 x Doors		RLBU60	600	RSBU60	600	RLBU60	600
RBA45	450	RBA12*	1200	Kesseböhmer Mechanism & Towel rail inc.				RSBU60	600			RLBU80*	800			RLBU80*	800
RBA50	500	*No muntin [2x300 doors]										RLBU90*	900			RLBU90*	900
RBA60	600	# 2 x Doors										RLBU10*	1000			RLBU10*	1000
												RLBU12*	1200			RLBU12*	1200
																	# 2 x Doors

**HI-LINE CORNER BASE** 'L' Shaped Diagonal **DRAWERLINE BASE** Single Top Drawer **DRAWERLINE SINK BASE** **CERAMIC SINK BASE**

H:720mm	WIDTH	CODE	WIDTH	H:720mm	WIDTH	H:720mm	WIDTH	H:720mm	WIDTH	H:720mm	WIDTH	H:720mm	WIDTH	H:720mm	WIDTH	H:460mm	WIDTH
RBAC830	800/300	RBAC950	900/500	BAC90	900x900	CDA90	900x900	RBD30	300	RBD80/1	800	RBDF50	500	RBD50	500	RBSU60	600
RBAC80	800/400	RBAC960	900/600	Bi-fold hinge system Flatpack				RBD40	400	RBD90/1	900	RBDF60	600	RBD45	450	To suit a sink height of 260mm	
RBAC845	800/450	RBAC140	1000/400					RBD45	450	RBD10/1	1000	RBDF80*	800	RBD50	500		
RBAC850	800/500	RBAC145	1000/450					RBD60	600			RBDF90*	900	RBD60	600		
RBAC860	800/600	RBAC160	1000/500					RBD80*	800			RBDF10*	1000	RBD80*	800		
RBAC940	900/400	RBAC160	1000/600					RBD90*	900			RBD10*	1000	RBD90*	900		
RBAC945	900/450	RBAC12	1200/600					RBD10*	1000			RBD12*	1200	RBD12*	1200		
								RBD12*	1200								

**DRAWERLINE CORNER BASE** **BUILT UNDER** Oven Microwave **2 DRAWER BASE** **3 DRAWER BASE** **4 DRAWER BASE** **5 DRAWER BASE** **LOW WALL**

H:720mm	WIDTH	CODE	WIDTH	H:720mm	WIDTH	H:720mm	WIDTH	H:720mm	WIDTH	H:720mm	WIDTH	H:720mm	WIDTH	H:720mm	WIDTH	H:575mm	WIDTH
RBDC830	800/300	RBDC140	1000/400	RBUM60	600	RBD250	500	RBD350	500	RBD450	500	RBD530	300	RWD30-5	300	R2WU60-5*	600
RBDC80	800/400	RBDC145	1000/450	Microwave		RBD260	600	RBD360	600	RBD460	600	RBD540	400	RWD40-5	400	RWD80-5*	800
RBDC845	800/450	RBDC160	1000/500			RBD280	800	RBD380	800	RBD480	800	RBD545	450	RWD45-5	450	RWD90-5*	900
RBDC850	800/500	RBDC10	1000/600			RBD290	900	RBD390	900	RBD490	900	RBD550	500	RWD50-5	500	RWD10-5*	1000
RBDC860	800/600	RBDC12	1200/600			RBD210	1000	RBD310	1000	RBD410	1000	RBD560	600	RWD60-5	600		*No muntin # 2 x Doors
								RBD510	1000			RBD580	800				
								RBD590	900			RBD590	900				
								RBD510	1000								

**LOW WALL** Diagonal Corner Splayed **MEDIUM WALL** Glazed Door Diagonal Corner 'L' Shaped Corner Conventional Corner Splayed

H:575mm	WIDTH	CODE	WIDTH	H:575mm	WIDTH	H:720mm	WIDTH	H:720mm	WIDTH	H:720mm	WIDTH	H:720mm	WIDTH	H:720mm	WIDTH	H:720mm	WIDTH
RCWD60-5	600x600	RAWU360-5	360	RWU26-7	260	R2WU60-7*	600	RWG50-7	500	RCWD60-7	600x600	RCWL60-7	600x600	RWU60-7	600	RAWU360-7	360

**MEDIUM WALL** Curved Door Microwave Wall Bi-Fold **TALL WALL** Glazed Door Diagonal Corner Splayed Boiler Wall

H:720mm	WIDTH	CODE	WIDTH	H:720mm	WIDTH	H:900mm	WIDTH	H:900mm	WIDTH	H:900mm	WIDTH	H:900mm	WIDTH	H:900mm	WIDTH
RCDWU30	300x300	RMWU60-7	600	RBFWU50-7	500	RWU30-9	300	R2WU60-9*	600	RWG50-9	500	H:900mm	WIDTH	RCWD60-9	600x600

Note: Furniture codes beginning with the letter 'R' are assembled (rigid), by removing the 'R' the units are supplied unassembled (flat-pack).

**HORIZONTAL WALL** **GLAZED DRESSER** **OPEN WALL**

H:290mm	WIDTH	CODE	WIDTH	H:360mm	WIDTH	H:1210mm	WIDTH	H:290mm	WIDTH	H:360mm	WIDTH	H:575mm	WIDTH	H:720mm	WIDTH	H:900mm	WIDTH
RHWU5029	500	RHWU5036	500	RDR2/50	500	RWOS50-2	500	RWOS50-3	500	RWOS30-5	300	RWOS30-7	300	RWOS30-9	300	RWOS40-9	400
RHWU6029	600	RHWU6036	600	Dresser Unit - 1 drawer Add 'X' to the end of the code for 350mm deep		RWOS60-2	600	RWOS60-3	600	RWOS40-5	400	RWOS40-7	400	RWOS40-9	400	RWOS45-9	450
RHWU8029	800	RHWU8036	800			RWOS80-2	800	RWOS80-3	800	RWOS45-5	450	RWOS45-7	450	RWOS45-9	450	RWOS50-9	500
RHWU9029	900	RHWU9036	900			RWOS90-2	900	RWOS90-3	900	RWOS50-5	500	RWOS50-7	500	RWOS50-9	500	RWOS60-9	600
RHWU1029	1000	RHWU1036	1000			RWOS10-2	1000	RWOS10-3	1000	RWOS60-5	600	RWOS60-7	600	RWOS60-9	600	RWOS60-9	600
										RWOS80-5	800	RWOS80-7	800	RWOS80-9	800	RWOS90-9	900
										RWOS90-5	900	RWOS90-7	900	RWOS90-9	900	RWOS10-9	1000
										RWOS10-5	1000	RWOS10-7	1000	RWOS10-9	1000		

**OPEN WALL** **MIDI UNITS** RMLU60 RMA160 RMD060 RMOH560 **LARDER** Diagonal **DRAWER LARDER** **'L' Shaped** Diagonal Walk-in Larder

H:1210mm	WIDTH	CODE	WIDTH	H:1250mm	WIDTH	H:1970mm	WIDTH	H:2150mm	WIDTH	H:1970mm	WIDTH	H:1970mm	WIDTH	H:1970mm	WIDTH	H:1970mm	WIDTH
RDC1/50	500	RMLU60	600	RMD060	600	RMOH560	600	RTL30	300	RETU30	300	TDLU80	800	TCLU98	985x985	TDWIL1144	1144x1144
RDC1/60	600	RMA160	600	RMOH560	600			RTL40	400	RETU40	400	TDLU10	1000	ETCLU98*	985x985	ETDWIL1144*	1144x1144
								RTL50	500	RETU50	500						
								RTL60	600	RETU60	600						
								TLU80	800	ETLU80	800						
								TLU10	1000	ETLU10	1000						

**LARDER** Diagonal **PULL-OUT LARDER** **INNER DRAWER LARDER** **DOUBLE OVEN** **SINGLE OVEN** **SINGLE OVEN + COMPACT**

H:1970mm	WIDTH	CODE	WIDTH	H:1970mm	WIDTH	H:1970mm	WIDTH	H:2150mm	WIDTH	H:1970mm	WIDTH	H:1970mm	WIDTH	H:1970mm	WIDTH	H:1970mm	WIDTH
TDCLU1003	1003x1003	RTSPOL30	300	RTLID30	300	RETLD30	300	RTOHD60	600	RTOHS60	600	RTOHC60	600	RTOHC60*	600	RTOHC60*	600
ETDCLU1003*	1003x1003	RTKPOL30	300	RTLID40	400	RETLD40	400	RTOHD60	600	RTOHS60	600	RTOHC60	600	RTOHC60*	600	RTOHC60*	600
		Standard Mechanism inc.		RTLID50	500	RETLD50	500	RETLD60	600	RETLD60	600						
		RETSPOL30*	300	RTLID60	600	RETLD60	600										
		Kesseböhmer Mechanism inc.															

**COMPACT** **TALL FRIDGE/FREEZER** **BOX WINE RACKS** **END SUPPORT PANELS** **CARCASE MFC PANELS** **CORNICE**

H:1970mm	WIDTH	CODE	WIDTH	H:1970mm	WIDTH	H:2150mm	WIDTH	W:125mm / W:250mm*	H:900mm	WIDTH	CODE	WXH	H:62mm	WIDTH		
RTOHC60	600	RTFF1/60	600	RTFF1U/60*	600	RTFF2/60	600	RWR125-7	720	ESP	600	1970/300	300x1970	COH/TM	3000	
RETOHC60*	600	RTFF4/60*	600	RTFF4U/60*	600	RTFF1U/60*	600	RWR250-7*	720	MFC Carcase	700	2150/560	560x2150			
		*Doors supplied undrilled		# For door on door appliances		RTFF2U/60*	600	RWR250-9*	900			2350/660	660x2350			
						# For door on door appliances		RWR250-9*	900			720/300	300x720			
								RWR125-1210	1210			900/2000	2000x900			
								WR125-1970	1970			900/300	300x900			
								WR250-1970*	1970			MFC Carcase				
												UG**ET	1000x22			

**CORNICE** Curved Classic Cornice Section **PLINTH** Curved Plinth Section Clear Sealing Strip **PLANT ON END PANELS**

H:62mm	WIDTH	CODE	WIDTH	H:30mm	WIDTH	H:30mm	WIDTH	H
--------	-------	------	-------	--------	-------	--------	-------	---



SHAKER  
PRICE GROUP 2  
**ROMA**

Special sizes available  
contact us for further information





Colours Options [PG 2]: Cashmere, Dust Grey, Fern, Grey, Indigo, Oyster, Sage and White.

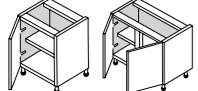
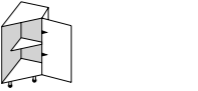
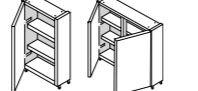
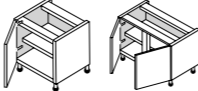



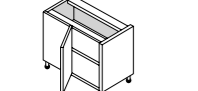

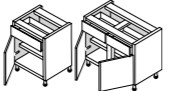
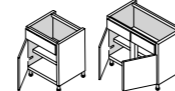
HI-LINE BASE LOW BASE

<p><b>Pull-Out</b></p> 		<p><b>Splayed</b></p> 		<p><b>Shallow Base [300mm deep]</b></p> 		<p><b>LOW BASE</b></p> 	
H:720mm CODE <b>RBA15</b> 150 <b>RBA25</b> 250 <b>RBA30</b> 300 <b>RBA35</b> 350 <b>RBA40</b> 400 <b>RBA45</b> 450 <b>RBA50</b> 500 <b>RBA60</b> 600	WIDTH <b>RCWA60*</b> 600 <b>RBA70*</b> 700 <b>RBA80*</b> 800 <b>RBA90*</b> 900 <b>RBA10*</b> 1000 <b>RBA12*</b> 1200 *No muntin [2x300 doors] # 2 x Doors	H:720mm CODE <b>RBISOP15</b> 150 <b>RBA360</b> 360	WIDTH <b>RBISOP15</b> 150 Standard Mechanism inc.	H:720mm CODE <b>RSBU30</b> 300 <b>RSBU35</b> 350 <b>RSBU40</b> 400 <b>RSBU45</b> 450 <b>RSBU50</b> 500 <b>RSBU60</b> 600	WIDTH <b>RSBU70*</b> 700 <b>RSBU80*</b> 800 <b>RSBU90*</b> 900 <b>RSBU10*</b> 1000 # 2 x Doors	H:720mm CODE <b>RLBU30</b> 300 <b>RLBU40</b> 400 <b>RLBU45</b> 450 <b>RLBU50</b> 500 <b>RLBU60</b> 600	WIDTH <b>RLBU80*</b> 800 <b>RLBU90*</b> 900 <b>RLBU10*</b> 1000 <b>RLBU12*</b> 1200 # 2 x Doors



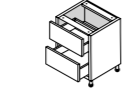
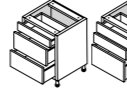

HI-LINE CORNER BASE DRAWERLINE BASE DRAWERLINE SINK BASE CERAMIC SINK BASE

<p><b>HI-LINE CORNER BASE</b></p> 		<p><b>'L' Shaped</b></p> 		<p><b>Diagonal</b></p> 		<p><b>DRAWERLINE BASE</b></p> 		<p><b>DRAWERLINE SINK BASE</b></p> 		<p><b>CERAMIC SINK BASE</b></p> 	
H:720mm CODE <b>RBAC830</b> 800/300 <b>RBAC80</b> 800/400 <b>RBAC845</b> 800/450 <b>RBAC850</b> 800/500 <b>RBAC860</b> 800/600 <b>RBAC940</b> 900/400 <b>RBAC945</b> 900/450	WIDTH <b>RBAC950</b> 900/500 <b>RBAC960</b> 900/600 <b>RBAC140</b> 1000/400 <b>RBAC145</b> 1000/450 <b>RBAC10</b> 1000/500 <b>RBAC160</b> 1000/600 <b>RBAC12</b> 1200/600	H:720mm CODE <b>RBAC90</b> 900x900 <b>CDA90</b> 900x900	WIDTH <b>RBAC90</b> 900x900 Bi-fold hinge system Flatpack	H:720mm CODE <b>RBD30</b> 300 <b>RBD40</b> 400 <b>RBD45</b> 450 <b>RBD50</b> 500 <b>RBD60</b> 600 <b>RBD80*</b> 800 <b>RBD90*</b> 900 <b>RBD10*</b> 1000 <b>RBD12*</b> 1200 # 2 x Doors	WIDTH <b>RBD80/1</b> 800 <b>RBD90/1</b> 900 <b>RBD10/1</b> 1000	H:720mm CODE <b>RBD50</b> 500 <b>RBD60</b> 600 <b>RBD90*</b> 900 <b>RBD10*</b> 1000 <b>RBD12*</b> 1200 *One working drawer # 2 x Doors	H:720mm CODE <b>RBDF50</b> 500 <b>RBDF60</b> 600 <b>RBDF80*</b> 800 <b>RBDF90*</b> 900 <b>RBDF10*</b> 1000 <b>RBDD10*</b> 1000 <b>RBDD12*</b> 1200 *One working drawer # 2 x Doors	H:460mm CODE <b>RBSU60</b> 600	WIDTH To suit a sink height of 260mm		



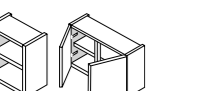



DRAWERLINE CORNER BASE BUILT UNDER 2 DRAWER BASE 3 DRAWER BASE 4 DRAWER BASE 5 DRAWER BASE

<p><b>DRAWERLINE CORNER BASE</b></p> 		<p><b>BUILT UNDER</b></p> <p>Oven </p> <p>Microwave </p>		<p><b>2 DRAWER BASE</b></p> 		<p><b>3 DRAWER BASE</b></p> 		<p><b>4 DRAWER BASE</b></p> 		<p><b>5 DRAWER BASE</b></p> 	
H:720mm CODE <b>RBDC830</b> 800/300 <b>RBDC80</b> 800/400 <b>RBDC845</b> 800/450 <b>RBDC850</b> 800/500 <b>RBDC860</b> 800/600	WIDTH <b>RBDC140</b> 1000/400 <b>RBDC145</b> 1000/450 <b>RBDC10</b> 1000/500 <b>RBDC160</b> 1000/600 <b>RBDC12</b> 1200/600	H:720mm CODE <b>RBU060</b> 600 <b>RBUM60</b> 600	WIDTH 600 175mm drawer & 110mm filler	H:720mm CODE <b>RBD250</b> 500 <b>RBD260</b> 600 <b>RBD280</b> 800 <b>RBD290</b> 900 <b>RBD210</b> 1000	WIDTH 500 600 800 900 1000	H:720mm CODE <b>RBD350</b> 500 <b>RBD360</b> 600 <b>RBD380</b> 800 <b>RBD390</b> 900 <b>RBD310</b> 1000	WIDTH 500 600 800 900 1000	H:720mm CODE <b>RBD450</b> 500 <b>RBD460</b> 600 <b>RBD480</b> 800 <b>RBD490</b> 900 <b>RBD410</b> 1000	WIDTH 500 600 800 900 1000	H:720mm CODE <b>RBD530</b> 300 <b>RBD540</b> 400 <b>RBD545</b> 450 <b>RBD550</b> 500 <b>RBD560</b> 600 <b>RBD580</b> 800 <b>RBD590</b> 900 <b>RBD510</b> 1000	WIDTH 300 400 450 500 600 800 900 1000



LOW WALL MEDIUM WALL

<p><b>LOW WALL</b></p> 		<p><b>MEDIUM WALL</b></p> <p><b>Diagonal Corner</b> </p> <p><b>Splayed</b> </p> <p><b>Glazed Door</b> </p> <p><b>Diagonal Corner</b> </p>								
H:575mm CODE <b>RWU30-5</b> 300 <b>RWU40-5</b> 400 <b>RWU45-5</b> 450 <b>RWU50-5</b> 500 <b>RWU60-5</b> 600	WIDTH <b>R2WU60-5*</b> 600 <b>RWU80-5*</b> 800 <b>RWU90-5*</b> 900 <b>RWU10-5*</b> 1000 *No muntin # 2 x Doors	H:575mm CODE <b>RCWD60-5</b> 600x600 <b>RAWU360-5</b> 360	WIDTH 600x600 360 Add 'X' to the end of the code for 350mm deep [650x650]	H:720mm CODE <b>RWU25-7</b> 250 <b>RWU30-7</b> 300 <b>RWU35-7</b> 350 <b>RWU40-7</b> 400 <b>RWU45-7</b> 450 <b>RWU50-7</b> 500 <b>RWU60-7</b> 600	WIDTH 250 300 350 400 450 500 600	H:720mm CODE <b>R2WU60-7*</b> 600 <b>RWU70-7*</b> 700 <b>RWU80-7*</b> 800 <b>RWU90-7*</b> 900 <b>RWU10-7*</b> 1000 *No muntin [2x300 doors] # 2 x Doors	H:720mm CODE <b>RWG50-7</b> 500 <b>RWG10-7</b> 1000	WIDTH 500 1000 Add 'X' to the end of the code for 350mm deep	H:720mm CODE <b>RCWD60-7</b> 600x600 <b>RAWU360-7</b> 360	WIDTH 600x600 360 Add 'X' to the end of the code for 350mm deep [650x650]

MEDIUM WALL TALL WALL

<p><b>MEDIUM WALL</b></p> <p><b>'L' Shaped Corner</b> </p> <p><b>Conventional Corner</b> </p> <p><b>Splayed</b> </p> <p><b>Microwave Wall</b> </p> <p><b>Bi-Fold</b> </p>		<p><b>TALL WALL</b></p> <p><b>Glazed Door</b> </p>										
H:720mm CODE <b>RCWL60-7</b> 600x600 Bi-fold hinge system Add 'X' to the end of the code for 350mm deep [650x650]	WIDTH 600x600 600	H:720mm CODE <b>RAWU360-7</b> 360	WIDTH 360 Add 'X' to the end of the code for 350mm deep	H:720mm CODE <b>RMWU60-7</b> 600	WIDTH 600 283mm flap, 110mm filler; Mechanism inc. Add 'X' to the end of the code for 350mm deep	H:720mm CODE <b>RBFWU50-7</b> 500 <b>RBFWU60-7</b> 600 <b>RBFWU80-7</b> 800 <b>RBFWU90-7</b> 900 <b>RBFWU10-7</b> 1000	WIDTH 500 600 800 900 1000	H:900mm CODE <b>RWU30-9</b> 300 <b>RWU40-9</b> 400 <b>RWU45-9</b> 450 <b>RWU50-9</b> 500 <b>RWU60-9</b> 600	WIDTH 300 400 450 500 600	H:900mm CODE <b>R2WU60-9*</b> 600 <b>RWU80-9*</b> 800 <b>RWU90-9*</b> 900 <b>RWU10-9*</b> 1000 *No muntin [2x300 doors] # 2 x Doors	H:900mm CODE <b>RGW50-9</b> 500 <b>RGW10-9</b> 1000	WIDTH 500 1000 Add 'X' to the end of the code for 350mm deep

Note: Furniture codes beginning with the letter 'R' are assembled (rigid), by removing the 'R' the units are supplied unassembled (flat-pack).



<p><b>TALL WALL</b></p> <p><b>Diagonal Corner</b> </p> <p><b>Splayed</b> </p> <p><b>Boiler Wall</b> </p>		<p><b>HORIZONTAL WALL</b></p> <p><b>RHWU5029</b> 500 <b>RHWU6029</b> 600 <b>RHWU8029</b> 800 <b>RHWU9029</b> 900 <b>RHWU1029</b> 1000</p>		<p><b>CODE</b> <b>WIDTH</b></p> <p><b>RHWU5036</b> 500 <b>RHWU6036</b> 600 <b>RHWU8036</b> 800 <b>RHWU9036</b> 900 <b>RHWU1036</b> 1000</p>		<p><b>GLAZED DRESSER</b></p> <p><b>RDR1/50</b> 500</p>		<p><b>OPEN WALL</b></p> <p><b>RWOS50-2</b> 500 <b>RWOS60-2</b> 600 <b>RWOS80-2</b> 800 <b>RWOS90-2</b> 900 <b>RWOS10-2</b> 1000</p>		<p><b>MFC Carcase</b></p> <p><b>RWOS50-3</b> 500 <b>RWOS60-3</b> 600 <b>RWOS80-3</b> 800 <b>RWOS90-3</b> 900 <b>RWOS10-3</b> 1000</p>			
H:900mm CODE <b>RCWD60-9</b> 600x600	WIDTH 600x600 Add 'X' to the end of the code for 350mm deep [650x650]	H:900mm CODE <b>RAWU360-9</b> 360	WIDTH 360 Add 'X' to the end of the code for 350mm deep	H:900mm CODE <b>BUW6040-9</b> 600	WIDTH 600 400mm Deep Flatpack	H:290mm CODE <b>RHWU5029</b> 500 <b>RHWU6029</b> 600 <b>RHWU8029</b> 800 <b>RHWU9029</b> 900 <b>RHWU1029</b> 1000	H:360mm CODE <b>RHWU5036</b> 500 <b>RHWU6036</b> 600 <b>RHWU8036</b> 800 <b>RHWU9036</b> 900 <b>RHWU1036</b> 1000	H:1210mm CODE <b>RDR1/50</b> 500	WIDTH 500 Dresser Unit - 1 door Add 'X' to the end of the code for 350mm deep	H:290mm CODE <b>RWOS50-2</b> 500 <b>RWOS60-2</b> 600 <b>RWOS80-2</b> 800 <b>RWOS90-2</b> 900 <b>RWOS10-2</b> 1000	WIDTH 500 600 800 900 1000	H:360mm CODE <b>RWOS50-3</b> 500 <b>RWOS60-3</b> 600 <b>RWOS80-3</b> 800 <b>RWOS90-3</b> 900 <b>RWOS10-3</b> 1000	WIDTH 500 600 800 900 1000

Add 'X' to the end of the code for 350mm deep







If 350mm deep carcase is required adjust code, e.g RWOS1035-2

If 350mm deep carcase is required adjust code, e.g RWOS1035-3



OPEN WALL MIDI UNITS LARDER

<p><b>OPEN WALL</b></p> 		<p><b>MIDI UNITS</b></p> 		<p><b>LARDER</b></p> <p><b>RMLU60</b> 600 <b>RMA160</b> 600 <b>RMD060</b> 600 <b>RMOH560</b> 600</p>		<p><b>RTLU30</b> 300 <b>RTLU40</b> 400 <b>RTLU50</b> 500 <b>RTLU60</b> 600 <b>TLU80</b> 800 <b>TLU10</b> 1000</p>		<p><b>RETLU30</b> 300 <b>RETLU40</b> 400 <b>RETLU50</b> 500 <b>RETLU60</b> 600 <b>ETLU80</b> 800 <b>ETLU10</b> 1000</p>			
H:575mm CODE <b>RWOS30-5</b> 300 <b>RWOS40-5</b> 400 <b>RWOS45-5</b> 450 <b>RWOS50-5</b> 500 <b>RWOS60-5</b> 600 <b>RWOS80-5</b> 800 <b>RWOS90-5</b> 900 <b>RWOS10-5</b> 1000	WIDTH 300 400 450 500 600 800 900 1000 MFC Carcase	H:720mm CODE <b>RWOS30-7</b> 300 <b>RWOS40-7</b> 400 <b>RWOS45-7</b> 450 <b>RWOS50-7</b> 500 <b>RWOS60-7</b> 600 <b>RWOS80-7</b> 800 <b>RWOS90-7</b> 900 <b>RWOS10-7</b> 1000	WIDTH 300 400 450 500 600 800 900 1000 MFC Carcase	H:900mm CODE <b>RWOS30-9</b> 300 <b>RWOS40-9</b> 400 <b>RWOS45-9</b> 450 <b>RWOS50-9</b> 500 <b>RWOS60-9</b> 600 <b>RWOS80-9</b> 800 <b>RWOS90-9</b> 900 <b>RWOS10-9</b> 1000	WIDTH 300 400 450 500 600 800 900 1000 MFC Carcase	H:1210mm CODE <b>RDC1/50</b> 500 <b>RDC1/60</b> 600	WIDTH 500 600 MFC Carcase	H:1970mm CODE <b>RTLU30</b> 300 <b>RTLU40</b> 400 <b>RTLU50</b> 500 <b>RTLU60</b> 600 <b>TLU80</b> 800 <b>TLU10</b> 1000	WIDTH 300 400 500 600 800 1000	H:2150mm CODE <b>RETLU30</b> 300 <b>RETLU40</b> 400 <b>RETLU50</b> 500 <b>RETLU60</b> 600 <b>ETLU80</b> 800 <b>ETLU10</b> 1000	WIDTH 300 400 500 600 800 1000



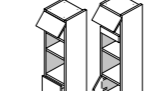
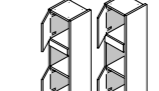
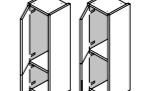
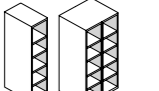

LARDER PULL-OUT LARDER INNER DRAWER LARDER

<p><b>LARDER</b></p> <p><b>Drawer Larder</b> </p> <p><b>'L' Shaped</b> </p> <p><b>Diagonal Walk-in Larder</b> </p> <p><b>Diagonal</b> </p>		<p><b>PULL-OUT LARDER</b></p> 		<p><b>INNER DRAWER LARDER</b></p> 									
H:1970mm CODE <b>TDLU80</b> 800 <b>TDLU10</b> 1000	WIDTH 800 1000 2x355mm Drawers	H:1970mm CODE <b>TCLU98</b> 985x985 <b>ETCLU98*</b> 985x985	WIDTH 985x985 985x985 Bi-fold hinge system	H:1970mm CODE <b>TDWIL144</b> 1144x1144 <b>ETDWIL144*</b> 1144x1144	WIDTH 1144x1144 1144x1144	H:1970mm CODE <b>TDCLU1003</b> 1003x1003 <b>ETDCLU1003*</b> 1003x1003	WIDTH 1003x1003 1003x1003	H:1970mm CODE <b>RTISPOL30</b> 300 <b>RTIFPOL30</b> 300 <b>RTETPOL30*</b> 300	WIDTH 300 300 300 Kesseböhmer Mechanism inc.	H:1970mm CODE <b>RTLID30</b> 300 <b>RTLID40</b> 400 <b>RTLID50</b> 500 <b>RTLID60</b> 600	WIDTH 300 400 500 600 1 x Standard, 4 x Deep drawers	H:2150mm CODE <b>RETLID30</b> 300 <b>RETLID40</b> 400 <b>RETLID50</b> 500 <b>RETLID60</b> 600	WIDTH 300 400 500 600

DOUBLE OVEN SINGLE OVEN SINGLE OVEN + COMPACT COMPACT TALL FRIDGE/FREEZER BOX WINE RACKS

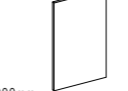
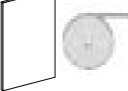
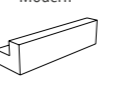
<p><b>DOUBLE OVEN</b></p> 		<p><b>SINGLE OVEN</b></p> 		<p><b>SINGLE OVEN + COMPACT</b></p> 		<p><b>COMPACT</b></p> 		<p><b>TALL FRIDGE/FREEZER</b></p> 		<p><b>BOX WINE RACKS</b></p> 			
H:1970mm CODE <b>RTOHDD60</b> 600 <b>RTOHDD60*</b> 600	WIDTH 600 600	H:1970mm CODE <b>RTOH560</b> 600 <b>RTOH560*</b> 600	WIDTH 600 600	H:1970mm CODE <b>RTOH5C60</b> 600 <b>RETOH5C60*</b> 600	WIDTH 600 600	H:1970mm CODE <b>RTOH60</b> 600 <b>RETOH60*</b> 600	WIDTH 600 600	H:1970mm CODE <b>RTFF1/60</b> 600 <b>RTFF2/60</b> 600 <b>RTFF3/60*</b> 600 <b>RTFFU/60*</b> 600 <b>RTFF3U/60*</b> 600	WIDTH 600 600 600 600 600 *Doors supplied undrilled *For door on door appliances	H:2150mm CODE <b>RTFF1/60</b> 600 <b>RTFF2/60</b> 600 <b>RTFF1U/60*</b> 600 <b>RTFF2U/60*</b> 600	WIDTH 600 600 600 600 # For door on door appliances	W:125mm / W:250mm* CODE <b>RWR125-7</b> 720 <b>RWR250-7*</b> 720 <b>RWR125-9</b> 900 <b>RWR250-9*</b> 900 <b>RWR125-1210</b> 1210 <b>RWR125-1970</b> 1970 <b>WR250-1970*</b> 1970 If using as base order LEGSET	HEIGHT 350x1387 650x2400 650x2400 350x1387 350x1387 650x2400

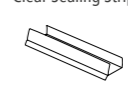
END SUPPORT PANELS CARCASE MFC PANELS CORNICE - MODERN PLINTH

<p><b>END SUPPORT PANELS</b></p> 		<p><b>CARCASE MFC PANELS</b></p> 		<p><b>CORNICE - MODERN</b></p> <p><b>Modern</b> </p>		<p><b>PLINTH</b></p> 		<p><b>Clear Sealing Strip</b></p> 		<p><b>18mm Plain</b></p> 		<p><b>18mm Tongue &amp; Grooved</b></p> 	
H:900mm CODE <b>ESP</b> 600 <b>900/700</b> 700	WIDTH 600 700 MFC Carcase	CODE <b>1970/300</b> 300x1970 <b>2150/560</b> 560x2150 <b>2350/660</b> 660x2350 <b>720/300</b> 300x720 <b>900/2000</b> 2000x900 <b>900/300</b> 300x900 MFC Carcase <b>UG/**ET</b> 1000x22 *Un-Glued 1m Carcase Edging	WXH 300x1970 560x2150 660x2350 300x720 2000x900 300x900	H:31mm CODE <b>CM/OF</b> 3000	WIDTH 3000 Door Finish	H:150mm CODE <b>PL</b> 2940	WIDTH 2940						

SHAKER  
PRICE GROUP 5, 7 + 8  
**SHOREDITCH**  
PAINT TO ORDER

Special sizes available  
contact us for further information

Standard Colours Options (PG5): Bone, Cotton, Fern,  
Putty, Riptide, Space, Twilight

PTO Colours Options (PG7): Auburn, Black, Cashmere, Coal,  
Dusty Rose, Forest, Mink, Mist, Moss, Navy, Sea Salt and Thyme.

Bespoke Colour Option (PG8)



HI-LINE BASE LOW BASE HI-LINE CORNER BASE HI-LINE CORNER BASE

**Pull-Out**  
H:720mm CODE WIDTH  
RBA15 150 RBA26 260 RBA30 300 RBA35 350 RBA40 400 RBA45 450 RBA50 500 RBA60 600  
R2BA60\* 600 RBA70\* 700 RBA80\* 800 RBA90\* 900 RBA10\* 1000 RBA12\* 1200  
\*No muntin [2x300 doors] # 2 x Doors

**Splayed**  
H:720mm CODE WIDTH  
RABA360 360

**Shallow Base [300mm deep]**  
H:720mm CODE WIDTH  
RSBU30 300 RSBU35 350 RSBU40 400 RSBU45 450 RSBU50 500 RSBU60 600 RSBU70\* 700 RSBU80\* 800 RSBU90\* 900 RSBU10\* 1000  
# 2 x Doors

**'L' Shaped**  
H:720mm CODE WIDTH  
BAC90 900x900  
Bi-fold hinge system Flat pack

**Diagonal**  
H:720mm CODE WIDTH  
CDA90 900x900  
Flat pack

**Curved Door**  
H:720mm CODE WIDTH  
RCDBA30 300x300

**Curved Return [300mm deep]**  
H:720mm CODE WIDTH  
RCRBA26 260

**Inc. Corner Post & Blanking Panel**

DRAWERLINE BASE DRAWERLINE SINK BASE CERAMIC SINK BASE DRAWERLINE CORNER BASE BUILT UNDER 2 DRAWER BASE 3 DRAWER BASE

**Single Top Drawer**  
H:720mm CODE WIDTH  
RBD30 300 RBD40 400 RBD45 450 RBD50 500 RBD60 600 RBD80\* 800 RBD90\* 900 RBD10\* 1000 RBD12\* 1200  
# 2 x Doors

**Open End Island Unit**  
H:720mm CODE WIDTH  
RBD30 300 RBD40 400 RBD45 450 RBD50 500 RBD60 600 RBD80\* 800 RBD90\* 900 RBD10\* 1000 RBD12\* 1200  
# 2 x Doors

**Oven**  
H:720mm CODE WIDTH  
RBU060 600

**Microwave**  
H:720mm CODE WIDTH  
RBUM60 600  
175mm drawer & 110mm filler

**2 DRAWER BASE**  
H:720mm CODE WIDTH  
RBD250 500 RBD260 600 RBD280 800 RBD290 900 RBD210 1000  
2x355mm Drawers

**3 DRAWER BASE**  
H:720mm CODE WIDTH  
RBD350 500 RBD360 600 RBD380 800 RBD390 900 RBD310 1000  
1x140mm, 2x283mm Drawers  
RBD350/175 500 RBD360/175 600  
2x175mm, 1x355mm Drawers

4 DRAWER BASE 5 DRAWER BASE LOW WALL MEDIUM WALL

**Diagonal Corner**  
H:720mm CODE WIDTH  
RBD450 500 RBD460 600 RBD480 800 RBD490 900 RBD410 1000  
3x140mm, 1x283mm drawers  
RBD450/175 500 RBD460/175 600  
4x175mm Drawers

**Diagonal Corner**  
H:575mm CODE WIDTH  
RWU30-5 300 RWU40-5 400 RWU45-5 450 RWU50-5 500 RWU60-5 600 R2WU60-5\* 600  
Add 'X' to the end of the code for 350mm deep [650x650]

**'L' Shaped Corner**  
H:720mm CODE WIDTH  
RCRWU50-7 500  
Painted Frame - MFC Oak Carcase Interior  
Add 'X' to the end of the code for 350mm deep

**Conventional Corner**  
H:720mm CODE WIDTH  
RCWU60-7 600  
Add 'X' to the end of the code for 350mm deep

**Splayed**  
H:720mm CODE WIDTH  
RAWU360-7 360  
Add 'X' to the end of the code for 350mm deep

**Curved Door**  
H:720mm CODE WIDTH  
RCDWU30-7 300x300

**Microwave Wall**  
H:720mm CODE WIDTH  
RMWU60-7 600  
283mm flap, 110mm filler; Mechanism inc.  
Add 'X' to the end of the code for 350mm deep

**Bi-Fold**  
H:720mm CODE WIDTH  
RBFWU50-7 500 RBFWU60-7 600 RBFWU80-7 800 RBFWU90-7 900 RBFWU10-7 1000  
Mechanism inc.  
Add 'X' to the end of the code for 350mm deep

MEDIUM WALL TALL WALL

**Framed Open Wall**  
H:720mm CODE WIDTH  
RFRWU50-7 500  
Painted Frame - MFC Oak Carcase Interior  
Add 'X' to the end of the code for 350mm deep

**Framed Open Wall - Crossrail**  
H:720mm CODE WIDTH  
RCRFRWU50-7 500  
Painted Frame - MFC Oak Carcase Interior  
Add 'X' to the end of the code for 350mm deep

**Diagonal Corner**  
H:720mm CODE WIDTH  
RCWU60-7 600  
Add 'X' to the end of the code for 350mm deep

**'L' Shaped Corner**  
H:720mm CODE WIDTH  
RCWL60-7 600x600  
Bi-fold hinge system  
Add 'X' to the end of the code for 350mm deep

**Conventional Corner**  
H:720mm CODE WIDTH  
RWU60-7 600  
Inc. Corner Post  
Add 'X' to the end of the code for 350mm deep

**Splayed**  
H:720mm CODE WIDTH  
RAWU360-7 360  
Add 'X' to the end of the code for 350mm deep

**Curved Door**  
H:720mm CODE WIDTH  
RCDWU30-7 300x300

**Microwave Wall**  
H:720mm CODE WIDTH  
RMWU60-7 600  
283mm flap, 110mm filler; Mechanism inc.  
Add 'X' to the end of the code for 350mm deep

**Bi-Fold**  
H:720mm CODE WIDTH  
RBFWU50-7 500 RBFWU60-7 600 RBFWU80-7 800 RBFWU90-7 900 RBFWU10-7 1000  
Mechanism inc.  
Add 'X' to the end of the code for 350mm deep

TALL WALL

**Glazed Door**  
H:900mm CODE WIDTH  
RWU30-9 300 RWU40-9 400 RWU45-9 450 RWU50-9 500 RWU60-9 600  
R2WU60-9\* 600 RWU80-9\* 800 RWU90-9\* 900 RWU10-9\* 1000  
\*No muntin [2x300 doors] # 2 x Doors

**Glazed - 2 Cross Rails**  
H:900mm CODE WIDTH  
RWG50-9 500 RWG10-9 1000 RWGR50-9\* 500 RWGR10-9\* 1000  
\*Reeded glass  
Add 'X' to the end of the code for 350mm deep

**Framed Open Wall**  
H:900mm CODE WIDTH  
RFRWU50-9 500  
Painted Frame - MFC Oak Carcase Interior  
Add 'X' to the end of the code for 350mm deep

**Framed Open Wall - Crossrail**  
H:900mm CODE WIDTH  
RCRFRWU50-9 500  
Painted Frame - MFC Oak Carcase Interior  
Add 'X' to the end of the code for 350mm deep

**Diagonal Corner**  
H:900mm CODE WIDTH  
RCWU60-9 600x600  
Add 'X' to the end of the code for 350mm deep

**Splayed**  
H:900mm CODE WIDTH  
RAWU360-9 360  
Add 'X' to the end of the code for 350mm deep

**Boiler Wall**  
H:900mm CODE WIDTH  
BWU6040-9 600  
400mm Deep Flat pack

HORIZONTAL WALL GLAZED DRESSER OPEN WALL

**H:290mm**  
CODE WIDTH  
RHU5029 500 RHU6029 600 RHU8029 800 RHU9029 900 RHU1029 1000

**H:1210mm**  
CODE WIDTH  
RDR2/50 500  
\*Reeded glass 1 drawer  
RCRDR2/50 500  
1 drawer, 2x cross rails

**H:360mm**  
CODE WIDTH  
RHU5036 500 RHU6036 600 RHU8036 800 RHU9036 900 RHU1036 1000

**H:290mm**  
CODE WIDTH  
RWOS50-2 500 RWOS60-2 600 RWOS80-2 800 RWOS90-2 900 RWOS10-2 1000  
MFC Carcase

**H:360mm**  
CODE WIDTH  
RWOS50-3 500 RWOS60-3 600 RWOS80-3 800 RWOS90-3 900 RWOS10-3 1000  
MFC Carcase

**H:575mm**  
CODE WIDTH  
RWOS30-5 300 RWOS40-5 400 RWOS45-5 450 RWOS50-5 500 RWOS60-5 600 RWOS80-5 800 RWOS90-5 900 RWOS10-5 1000  
MFC Carcase

**H:720mm**  
CODE WIDTH  
RWOS30-7 300 RWOS40-7 400 RWOS45-7 450 RWOS50-7 500 RWOS60-7 600 RWOS80-7 800 RWOS90-7 900 RWOS10-7 1000  
MFC Carcase

**H:900mm**  
CODE WIDTH  
RWOS30-9 300 RWOS40-9 400 RWOS45-9 450 RWOS50-9 500 RWOS60-9 600 RWOS80-9 800 RWOS90-9 900 RWOS10-9 1000  
MFC Carcase

**H:1210mm**  
CODE WIDTH  
RMLU60 600 RMA160 600  
RMD060 600 RMOHS60 600

**H:1250mm**  
CODE WIDTH  
RMD060 600 RMOHS60 600

**H:1250mm**  
CODE WIDTH  
RMD060 600 RMOHS60 600

**H:1250mm**  
CODE WIDTH  
RMD060 600 RMOHS60 600

**H:1250mm**  
CODE WIDTH  
RMD060 600 RMOHS60 600

LARDER

**One Cross Rail - Upper Door**  
H:1970mm CODE WIDTH  
RTL30 300 RTL40 400 RTLU50 500 RTLU60 600 TLU80 800 TLU10 1000

**Single Door - Two Cross Rails**  
H:1970mm CODE WIDTH  
RETL30 300 RETLU40 400 RETLU50 500 RETLU60 600 ETLU80 800 ETLU10 1000  
\*715mm bottom, 1425mm top door

**Drawer Larder**  
H:1970mm CODE WIDTH  
TDLU80 800 TDLU10 1000  
2x355mm drawers

**'L' Shaped**  
H:1970mm CODE WIDTH  
TCLU98 985x985 TCLU98\* 985x985  
Bi-fold hinge system

**Diagonal Walk-in Larder**  
H:1970mm CODE WIDTH  
TDWU1144 1144x1144

**Diagonal**  
H:1970mm CODE WIDTH  
ETDCLU1003 1003x1003

PULL-OUT LARDER INNER DRAWER LARDER DOUBLE OVEN SINGLE OVEN SINGLE OVEN + COMPACT COMPACT TALL FRIDGE/FREEZER

**PULL-OUT LARDER**  
H:1970mm CODE WIDTH  
RTIPOL30 300 RTKPOL30 300 RETISPOL30\* 300 RETKPOL30\* 300  
Standard Mechanism inc. Kesseböhmer Mechanism inc.

**INNER DRAWER LARDER**  
H:1970mm CODE WIDTH  
RTLID30 300 RTLID40 400 RTLID50 500 RTLID60 600

**DOUBLE OVEN**  
H:1970mm CODE WIDTH  
RTOHD60 600 RTOHDD60 600 RETOHD60\* 600

**SINGLE OVEN**  
H:1970mm CODE WIDTH  
RTOHS60 600 RTOHSD60 600 RETOHS60\* 600

**SINGLE OVEN + COMPACT**  
H:1970mm CODE WIDTH  
RTOHSC60 600 RETOHS60\* 600

**COMPACT**  
H:1970mm CODE WIDTH  
RTOHC60 600 RETOHC60\* 600

**TALL FRIDGE/FREEZER**  
H:1970mm CODE WIDTH  
RTFF4/60 600 RTFF1U/60\* 600 RTFF4U/60\* 600 RTFF1U/60\* 600 RTFF4U/60\* 600  
\*Doors undrilled  
\*For door on door appliances

TALL FRIDGE/FREEZER BOX WINE RACKS END SUPPORT PANELS CARCASE MFC PANELS CORNICE COMBI LIGHT BAFFLE

**PLINTH**  
H:2150mm CODE WIDTH  
RETFF1/60 600 RETFF2/60 600 RETFF3/60\* 600 RETFF1U/60\* 600 RETFF2U/60\* 600 RETFF3U/60\* 600  
Melamine [Carcase MFC] Door finish Veneered Filler Finished on both long edges - can be use as plinth \*Includes PST sealing strip

**Curved Plinth**  
H:150mm CODE WIDTH  
CPL/B 2440

**Decorative Plinth**  
H:170mm CODE WIDTH  
DECPL/B 3000

**18mm Tongue & Grooved Reversible**  
CODE WDX  
2440/390T/B 390x2440 2440/650T/B 650x2440 950/390T/B 390x950 885/650T/B 650x885

**18mm Plain Reversible**  
CODE WDX  
2440/390P/B 390x2440 2440/650P/B 650x2440 950/390P/B 390x950 885/650P/B 650x885

**18mm Tongue & Grooved / Plain Reversible**  
CODE WDX  
2440/390/B 390x2440 2440/650/B 650x2440 950/390/B 390x950 885/650/B 650x885

**18mm Tongue & Grooved / Plain Reversible Breakfast Bar Panel**  
CODE WDX  
900/2000T/B 2000x900 2440/650T/B 650x2440 950/390T/B 390x950 885/650T/B 650x885

**Square**  
H:910mm CODE WIDTH  
PIL/S910B 50

**Curved**  
H:910mm CODE WIDTH  
PIL/CUR910B 910  
PIL/CUR1350B 1350  
PIL/CUR2150B 2150

PLANT ON END PANELS INTEGRATED DOORS WINE CAB DOORS SPARE DOOR FITTINGS GENERAL ACCS.

**18mm Tongue & Grooved Reversible**  
CODE WDX  
2440/390T/B 390x2440 2440/650T/B 650x2440 950/390T/B 390x950 885/650T/B 650x885

**18mm Plain Reversible**  
CODE WDX  
2440/390P/B 390x2440 2440/650P/B 650x2440 950/390P/B 390x950 885/650P/B 650x885

**18mm Tongue & Grooved / Plain Reversible**  
CODE WDX  
2440/390/B 390x2440 2440/650/B 650x2440 950/390/B 390x950 885/650/B 650x885

**18mm Tongue & Grooved / Plain Reversible Breakfast Bar Panel**  
CODE WDX  
900/2000T/B 2000x900 2440/650T/B 650x2440 950/390T/B 390x950 885/650T/B 650x885

**Integrated Doors**  
H:1050mm CODE WDX  
DHSR/BNO 350x106 INT4571 446x715 INT6071 596x715

**Wine Cab Doors**  
CODE WDX  
WCD607 715x596 WCD60719 1790x596  
To suit Caple W1616 To suit Caple WC1800 wine cabinet

**Spare Door Fittings**  
Hinges [Hettich Soft Close] Code SCHINGE90 90 degree [Pair] SCHINGE170 170 degree [Pair] Code STAYS [Blum Aventos] Code BLSTAYHKS HK-S stay [Pair] [inc mounting brackets]

**General Accs.**  
Code STPNW Set of 2 Door Strapping Plates LEGSET Set of 4 Adjustable legs SACC Pk 50 14mm Self Adhesive Cover Caps Code PCC/B Painted Care Kit TOUCH/B Touch Up Paint 500ml

FURNITURE ACCESSORIES

**Corner Post [Spare]**  
H:715mm CODE WIDTH  
CP/B 146  
Flat Panel for on site conversion

**Mantle Shelf**  
H:25mm CODE WDX  
MS/B 2400x200  
Specify length required - can be made to size

**Decorative Corbel [Single]**  
H:219mm CODE WDX  
COR/B 107x95

**Door Hung Spice Rack**  
H:1050mm CODE WDX  
DHSR/BNO 350x106

Note: Furniture codes beginning with the letter 'R' are assembled (rigid), by removing the 'R' the units are supplied unassembled (flat-pack).

Note: Furniture codes beginning with the letter 'R' are assembled (rigid), by removing the 'R' the units are supplied unassembled (flat-pack).



SHAKER
PRICE GROUP 5 + 6
STANTON
PAINT TO ORDER

Special sizes available
contact us for further information

Stanton Sanded [PG5]

Stanton Oak [PG6]

PTO Colours Options [PG6]: Alabaster, Antique Red, Black, Blush, Charcoal, Dark Sage, Dust Grey, Federal Blue, Fern, Gunmetal, Heritage, Hunter, Indigo, Ink, Light Grey, Midnight Blue, Mussel, Palladian Blue, Porcelain and Woodland Grey.



HI-LINE BASE LOW BASE HI-LINE CORNER BASE

Table listing various kitchen base units including Pull-Out, Curved Door, Curved Return, Splayed, Shallow Base, and 'L' Shaped units with their respective codes and dimensions.

HI-LINE CORNER BASE DRAWERLINE BASE DRAWERLINE SINK BASE CERAMIC SINK BASE DRAWERLINE CORNER BASE

Table listing kitchen units with drawers and sinks, including Diagonal, Single Top Drawer, and various Sink Base options with codes and dimensions.

BUILT UNDER 2 DRAWER BASE 3 DRAWER BASE 4 DRAWER BASE 5 DRAWER BASE LOW WALL

Table listing built-under units and low wall units, including Oven, Microwave, and Diagonal Corner units with codes and dimensions.

MEDIUM WALL

Table listing medium wall units with various door styles like Glazed Door, Diagonal Corner, 'L' Shaped Corner, Conventional Corner, Splayed, Curved Door, and Microwave Wall.

MEDIUM WALL TALL WALL HORIZONTAL WALL

Table listing medium wall, tall wall, and horizontal wall units, including Bi-Fold, Glazed Door, Diagonal Corner, Splayed, Boiler Wall, and Bench Slats.

GLAZED DRESSER OPEN WALL MIDI UNITS

Table listing glazed dresser, open wall, and midi unit options with codes, dimensions, and notes on carcasses.

LARDER PULL-OUT LARDER

Table listing larder and pull-out larder units, including Larder, Drawer Larder, 'L' Shaped, Diagonal Walk-in Larder, and Diagonal options.

INNER DRAWER LARDER DOUBLE OVEN SINGLE OVEN SINGLE OVEN + COMPACT COMPACT TALL FRIDGE/FREEZER

Table listing inner drawer larder, double oven, single oven, single oven + compact, compact, and tall fridge/freezer units.

BOX WINE RACKS END SUPPORT PANELS CARCASE MFC PANELS WALL CANOPIES CORNICE LIGHT PELMET PLINTH

Table listing accessories including box wine racks, end support panels, carcass MFC panels, wall canopies, cornice, light pelmet, and plinth.

PLINTH PLANT ON END PANELS PILASTERS

Table listing plinth, plant on end panels, and pilasters accessories.

FURNITURE ACCESSORIES INTEGRATED DOORS WINE CAB DOORS SPARE DOOR FITTINGS GENERAL ACCS.

Table listing furniture accessories, integrated doors, wine cabinet doors, spare door fittings, and general accessories.

Note: Furniture codes beginning with the letter 'R' are assembled (rigid), by removing the 'R' the units are supplied unassembled (flat-pack).

SHAKER  
PRICE GROUP 7 + 8  
**WOBURN**  
PAINT TO ORDER

Special sizes available  
contact us for further information

Colour Options [PG7]: Auburn, Black, Bone, Dusty Rose, Cashmere, Coal, Cotton, Fern, Forest, Mink, Mist, Moss, Navy, Putty, Riptide, Sea Salt, Smoke, Space, Thyme and Twilight.

Bespoke Colour Option [PG8]



HI-LINE BASE | LOW BASE | HI-LINE CORNER BASE

HI-LINE BASE section featuring various cabinet door styles: Pull-Out, Curved Door, Curved Return, Splayed, Shallow Base [300mm deep], and 'L' Shaped. Each style includes a diagram, a table of codes (e.g., RBA15, RBAC30, RBAC80) and dimensions, and a description of the mechanism or feature.

HI-LINE CORNER BASE | DRAWERLINE BASE | DRAWERLINE SINK BASE | CERAMIC SINK BASE | DRAWERLINE CORNER BASE

HI-LINE CORNER BASE section showing various cabinet configurations: Single Top Drawer, Open End Island Unit, and Diagonal Corner. Includes diagrams, code tables (e.g., RBAC830, RBAC950, RBAC960), and descriptions of features like 'No muntin' and 'Standard Mechanism Inc.'

BUILT UNDER | 2 DRAWER BASE | 3 DRAWER BASE | 4 DRAWER BASE | 5 DRAWER BASE | LOW WALL

BUILT UNDER section featuring built-in units for Oven, Microwave, and various 2-5 drawer bases. Includes diagrams, code tables (e.g., RBUC60, RBDC30), and dimensions. Also includes LOW WALL section with codes like RWU30-5 and RWU60-5.

MEDIUM WALL | TALL WALL | HORIZONTAL WALL

MEDIUM WALL section featuring cabinet styles: Glazed Door, Diagonal Corner, 'L' Shaped Corner, Conventional Corner, Splayed, Curved Door, and Microwave Wall. Includes diagrams, code tables (e.g., RWU26-7, RWU30-7), and dimensions. Also includes TALL WALL and HORIZONTAL WALL sections with codes like RBFWU50-7 and RBWU029.

GLAZED DRESSER | OPEN WALL | MIDY UNITS | LARDER section. GLAZED DRESSER: RDR2/50, RDR2/50\*. OPEN WALL: RWOS50-2, RWOS60-2, RWOS80-2, RWOS90-2, RWOS10-2. MIDY UNITS: RMLU60, RMA160. LARDER: RTLU30, RTLU40, RTLU50, RTLU60, RTLU80, RTLU10. Includes diagrams and code tables with dimensions.

LARDER | PULL-OUT LARDER | INNER DRAWER LARDER section. LARDER: RETLU30, RETLU40, RETLU50, RETLU60, ETLU80, ETLU10, RETLU60/1\*. PULL-OUT LARDER: RTIPOL30, RTKPOL30, RETISPOL30, RETKPOL30\*. INNER DRAWER LARDER: RTLID30, RTLID40, RTLID60, RETLID30, RETLID40, RETLID50, RETLID60. Includes diagrams and code tables.

DOUBLE OVEN | SINGLE OVEN | SINGLE OVEN + COMPACT | COMPACT | TALL FRIDGE/FREEZER | BOX WINE RACKS | END SUPPORT PANELS section. DOUBLE OVEN: RTOHD60, RTOHDD60, RETOHD60\*. SINGLE OVEN: RTOHS60, RETOHS60\*. SINGLE OVEN + COMPACT: RTOHSC60, RETOHS60\*. COMPACT: RTOHC60, RETOHC60\*. TALL FRIDGE/FREEZER: RTFF1/60, RTFF4/60\*, RTFF1U/60\*, RTFF4U/60\*. BOX WINE RACKS: RWR125-7, RWR125-9, RWR125-1210, RWR125-1970. END SUPPORT PANELS: ESP 900/700. Includes diagrams and code tables.

CARCASE MFC PANELS | CORNICE | COMBI | LIGHT BAFFLE | PLINTH section. CARCASE MFC PANELS: 1970/300, 2150/560, 2350/660, 720/300, 900/2000, 900/300, UG/\*\*ET. CORNICE: Contemporary, Curved Cornice Section, Classic, H:80mm COCL/B. COMBI: Curved Combi Section, H:28mm CCMS/B. LIGHT BAFFLE: Curved Light Pelmet Section, H:50mm CLPS/B. PLINTH: Melamine [Carcass MFC], Veneered Filler. Includes diagrams and code tables.

PLINTH | PLANT ON END PANELS | PILASTERS section. PLINTH: Decorative Curved Plinth, Clear Sealing Strip, H:170mm CDECP/B. PLANT ON END PANELS: 18mm Tongue & Grooved Reversible, 18mm Plain Reversible, 18mm Tongue & Grooved / Plain Reversible, 18mm Tongue & Grooved / Plain Reversible Breakfast Bar Panel. PILASTERS: Square, Curved, H:910mm PLS910B. Includes diagrams and code tables.

FURNITURE ACCESSORIES | INTEGRATED DOORS | WINE CAB DOORS | SPARE DOOR FITTINGS | GENERAL ACCS. section. FURNITURE ACCESSORIES: Corner Post, Mantle Shelf, Decorative Corbel, Door Hung Spice Rack. INTEGRATED DOORS: Undrilled, H:1050mm INT4571. WINE CAB DOORS: WCD607, WCD60179. SPARE DOOR FITTINGS: Hinges, Stays. GENERAL ACCS: STPWN, SCHINGE90, SCHINGE170, BLSTAYHKS, PCC/B, TOUCH/B. Includes diagrams and code tables.

Note: Furniture codes beginning with the letter 'R' are assembled (rigid), by removing the 'R' the units are supplied unassembled (flat-pack).

Note: Furniture codes beginning with the letter 'R' are assembled (rigid), by removing the 'R' the units are supplied unassembled (flat-pack).

SHAKER  
PRICE GROUP 6 + 8  
**WOODFORD**

Special sizes available  
contact us for further information

PTO Options [PG6]: Calico, Dark Blue, Dark Green,  
Graphite, Light Grey, Luna and Porcelain.



Bespoke Colour Option [PG8]



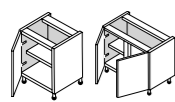
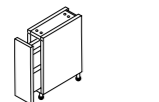
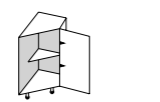
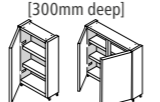
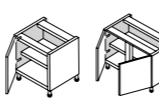

**HI-LINE BASE** **LOW BASE**

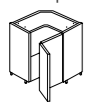
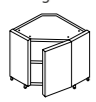
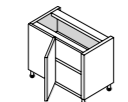
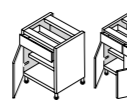
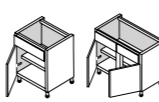
				
<b>H:720mm</b> CODE     WIDTH     CODE     WIDTH	<b>H:720mm</b> CODE     WIDTH     CODE     WIDTH	<b>H:720mm</b> CODE     WIDTH     CODE     WIDTH	<b>H:720mm</b> CODE     WIDTH     CODE     WIDTH	<b>H:575mm</b> CODE     WIDTH     CODE     WIDTH
<b>RBA15</b> 150 <b>R2BA60*</b> 600 <b>RBA26</b> 260 <b>RBA70#</b> 700 <b>RBA30</b> 300 <b>RBA80#</b> 800 <b>RBA35</b> 350 <b>RBA90#</b> 900 <b>RBA40</b> 400 <b>RBA10#</b> 1000 <b>RBA45</b> 450 <b>RBA12#</b> 1200 <b>RBA50</b> 500    *No muntin [2x300 doors] <b>RBA60</b> 600    # 2 x Doors	<b>RBISPO15</b> 150 Standard Mechanism inc.	<b>RBA360</b> 360	<b>RSBU30</b> 300 <b>RSBU70#</b> 700 <b>RSBU35</b> 350 <b>RSBU80#</b> 800 <b>RSBU40</b> 400 <b>RSBU90#</b> 900 <b>RSBU45</b> 450 <b>RSBU10#</b> 1000 <b>RSBU50</b> 500    # 2 x Doors <b>RSBU60</b> 600	<b>RLBU30</b> 300 <b>RLBU80#</b> 800 <b>RLBU40</b> 400 <b>RLBU90#</b> 900 <b>RLBU45</b> 450 <b>RLBU10#</b> 1000 <b>RLBU50</b> 500 <b>RLBU12#</b> 1200 <b>RLBU60</b> 600    # 2 x Doors

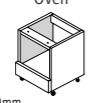
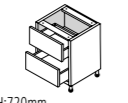
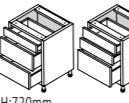
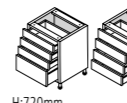

**HI-LINE CORNER BASE** **DRAWERLINE BASE** **DRAWERLINE SINK BASE** **CERAMIC SINK BASE**

					
<b>H:720mm</b> CODE     WIDTH     CODE     WIDTH	<b>H:720mm</b> CODE     WIDTH     CODE     WIDTH	<b>H:720mm</b> CODE     WIDTH     CODE     WIDTH	<b>H:720mm</b> CODE     WIDTH     CODE     WIDTH	<b>H:720mm</b> CODE     WIDTH     CODE     WIDTH	<b>H:720mm</b> CODE     WIDTH     CODE     WXH
<b>BAC90</b> 900x900 Bi-fold hinge system Flat pack	<b>CDA90</b> 900x900 Flat pack	<b>RBAC830</b> 800/300 <b>RBAC950</b> 900/500 <b>RBAC80</b> 800/400 <b>RBAC960</b> 900/600 <b>RBAC845</b> 800/450 <b>RBAC1000/400</b> <b>RBAC850</b> 800/500 <b>RBAC145</b> 1000/450 <b>RBAC860</b> 800/600 <b>RBAC10</b> 1000/500 <b>RBAC940</b> 900/400 <b>RBAC160</b> 1000/600 <b>RBAC945</b> 900/450 <b>RBAC12</b> 1200/600 Inc. Corner Post & Blanking Panel	<b>RBD30</b> 300 <b>RBD80/1</b> 800 <b>RBD40</b> 400 <b>RBD90/1</b> 900 <b>RBD45</b> 450 <b>RBD101/1</b> 1000 <b>RBD50</b> 500 <b>RBD60</b> 600 <b>RBD80#</b> 800 <b>RBD90#</b> 900 <b>RBD10#</b> 1000 <b>RBD12#</b> 1200 # 2 x Doors	<b>RBD50</b> 500 <b>RBDF50</b> 500 <b>RBD60</b> 600 <b>RBDF60</b> 600 <b>RBD80#</b> 800 <b>RBDF80#</b> 800 <b>RBD90#</b> 900 <b>RBDF90#</b> 900 <b>RBD10#</b> 1000 <b>RBDF10#</b> 1000 <b>RBD12#</b> 1200 <b>RBDF12#</b> 1200 *One working drawer # 2 x Doors	<b>RBSU60</b> 600x460 To suit a sink height of 260mm

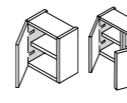
**DRAWERLINE CORNER BASE** **BUILT UNDER** **2 DRAWER BASE** **3 DRAWER BASE** **4 DRAWER BASE** **5 DRAWER BASE** **LOW WALL**

						
<b>H:720mm</b> CODE     WIDTH     CODE     WIDTH	<b>H:720mm</b> CODE     WIDTH     CODE     WIDTH	<b>H:720mm</b> CODE     WIDTH     CODE     WIDTH	<b>H:720mm</b> CODE     WIDTH     CODE     WIDTH	<b>H:720mm</b> CODE     WIDTH     CODE     WIDTH	<b>H:720mm</b> CODE     WIDTH     CODE     WIDTH	<b>H:575mm</b> CODE     WIDTH     CODE     WIDTH
<b>RBD30</b> 300 <b>RBD140</b> 1000/400 <b>RBD80</b> 800/400 <b>RBD145</b> 1000/450 <b>RBD845</b> 800/450 <b>RBD10</b> 1000/500 <b>RBD850</b> 800/500 <b>RBD160</b> 1000/600 <b>RBD860</b> 800/600 <b>RBD12</b> 1200/600 Inc. Corner Post & Blanking Panel	<b>RBUM60</b> 600 175mm drawer & 110mm filler	<b>RBUM060</b> 600	<b>RBD250</b> 500 <b>RBD350</b> 500 <b>RBD260</b> 600 <b>RBD360</b> 600 <b>RBD280</b> 800 <b>RBD380</b> 800 <b>RBD290</b> 900 <b>RBD390</b> 900 <b>RBD210</b> 1000 <b>RBD410</b> 1000 2x355mm Drawers	<b>RBD450</b> 500 <b>RBD550</b> 500 <b>RBD460</b> 600 <b>RBD545</b> 450 <b>RBD480</b> 800 <b>RBD540</b> 400 <b>RBD490</b> 900 <b>RBD550</b> 500 <b>RBD510</b> 1000 <b>RBD560</b> 600 1x140mm, 1x283mm Drawers 3x140mm, 1x283mm drawers 4x175mm Drawers	<b>RBD530</b> 300 <b>RBD540</b> 400 <b>RBD545</b> 450 <b>RBD550</b> 500 <b>RBD560</b> 600 <b>RBD580</b> 800 <b>RBD590</b> 900 <b>RBD510</b> 1000 5x140mm Drawers	<b>RWU30-5</b> 300 <b>R2WU60-5#</b> 600 <b>RWU40-5</b> 400 <b>RWU80-5#</b> 800 <b>RWU45-5</b> 450 <b>RWU90-5#</b> 900 <b>RWU50-5</b> 500 <b>RWU10-5#</b> 1000 <b>RWU60-5</b> 600    *No muntin [2 x 300 doors] # 2 x Doors

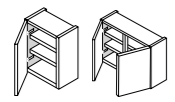
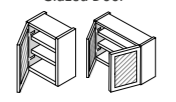
**MEDIUM WALL**

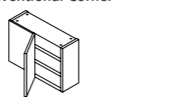
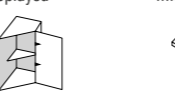
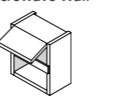
						
<b>H:720mm</b> CODE     WIDTH     CODE     WIDTH     D:300mm	<b>H:720mm</b> CODE     WIDTH     CODE     WIDTH     D:300mm	<b>H:720mm</b> CODE     WIDTH     CODE     WIDTH     D:300mm	<b>H:720mm</b> CODE     WIDTH     CODE     WIDTH     D:300mm	<b>H:720mm</b> CODE     WIDTH     CODE     WIDTH     D:300mm	<b>H:720mm</b> CODE     WIDTH     CODE     WIDTH     D:300mm	<b>H:720mm</b> CODE     WIDTH     CODE     WIDTH     D:300mm
<b>RWU26-7</b> 260 <b>R2WU60-7*</b> 600 <b>RWU30-7</b> 300 <b>RWU70-7#</b> 700 <b>RWU35-7</b> 350 <b>RWU80-7#</b> 800 <b>RWU40-7</b> 400 <b>RWU90-7#</b> 900 <b>RWU45-7</b> 450 <b>RWU10-7#</b> 1000 <b>RWU50-7</b> 500    *No muntin [2x300 doors] <b>RWU60-7*</b> 600    # 2 x Doors	<b>RBWG50-7*</b> 500 <b>RBWG10-7*</b> 1000 *Door style 79mm Shaker frame	<b>RCWD60-7</b> 600x600 Add 'X' to the end of the code for 350mm deep [650x650]	<b>RCWL60-7</b> 600x600 Bi-fold hinge system Add 'X' to the end of the code for 350mm deep [650x650]	<b>RWUC60-7</b> 600 Inc. Corner Post Add 'X' to the end of the code for 350mm deep	<b>RAWU360-7</b> 360 Add 'X' to the end of the code for 350mm deep	<b>RMWU60-7</b> 600 283mm flap, 110mm filler; Mechanism inc. Add 'X' to the end of the code for 350mm deep

**TALL WALL** **HORIZONTAL WALL**

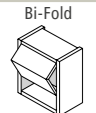
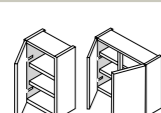
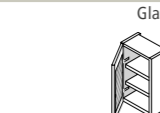
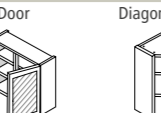
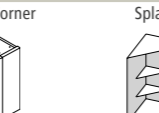
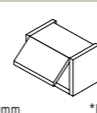
					
<b>H:720mm</b> CODE     WIDTH     H:900mm	<b>H:720mm</b> CODE     WIDTH     D:300mm	<b>H:900mm</b> CODE     WIDTH     D:300mm	<b>H:900mm</b> CODE     WIDTH     D:300mm	<b>H:900mm</b> CODE     WIDTH     D:300mm	<b>H:290mm</b> CODE     *H:360mm
<b>RBFWU50-7</b> 500 <b>RWU30-9</b> 300 <b>R2WU60-9*</b> 600 <b>RBFWU60-7</b> 600 <b>RWU40-9</b> 400 <b>RWU80-9#</b> 800 <b>RBFWU80-7</b> 800 <b>RWU45-9</b> 450 <b>RWU90-9#</b> 900 <b>RBFWU90-7</b> 900 <b>RWU50-9</b> 500 <b>RWU10-9#</b> 1000 <b>RBFWU10-7</b> 1000 <b>RWU60-9</b> 600    *No muntin [2x300 doors] Mechanism inc.    # 2 x Doors	<b>RWG50-9*</b> 500 <b>RWG10-9*</b> 1000 *Door style 79mm Shaker frame	<b>RCWD60-9</b> 600x600 Add 'X' to the end of the code for 350mm deep [650x650]	<b>RAWU360-9</b> 360 Add 'X' to the end of the code for 350mm deep	<b>BWU6040-9</b> 600 400mm Deep Flat pack	<b>RHWU5029</b> 500 <b>RHWU6029</b> 600 <b>RHWU8029</b> 800 <b>RHWU9029</b> 900 <b>RHWU1029</b> 1000 <b>RHWU5036*</b> 500 <b>RHWU6036*</b> 600 <b>RHWU8036*</b> 800 <b>RHWU1036*</b> 1000 Add 'X' to the end of the code for 350mm deep

**GLAZED DRESSER** **OPEN WALL**

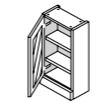
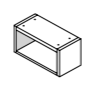
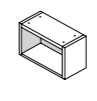
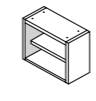
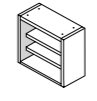
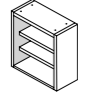
					
<b>H:1210mm</b> CODE     WIDTH	<b>H:290mm</b> CODE     WIDTH	<b>H:360mm</b> CODE     WIDTH	<b>H:575mm</b> CODE     WIDTH	<b>H:720mm</b> CODE     WIDTH	<b>H:900mm</b> CODE     *H:1210mm WIDTH
<b>RDR2/50*</b> 500 1 Drawer *Door style 79mm Shaker frame Add 'X' to the end of the code for 350mm deep	<b>RWOS50-2</b> 500 <b>RWOS60-2</b> 600 <b>RWOS80-2</b> 800 <b>RWOS90-2</b> 900 <b>RWOS10-2</b> 1000 MFC Carcase	<b>RWOS50-3</b> 500 <b>RWOS60-3</b> 600 <b>RWOS80-3</b> 800 <b>RWOS90-3</b> 900 <b>RWOS10-3</b> 1000 MFC Carcase	<b>RWOS30-5</b> 300 <b>RWOS40-5</b> 400 <b>RWOS45-5</b> 450 <b>RWOS50-5</b> 500 <b>RWOS60-5</b> 600 <b>RWOS80-5</b> 800 <b>RWOS90-5</b> 900 <b>RWOS10-5</b> 1000 MFC Carcase	<b>RWOS30-7</b> 300 <b>RWOS40-7</b> 400 <b>RWOS45-7</b> 450 <b>RWOS50-7</b> 500 <b>RWOS60-7</b> 600 <b>RWOS80-7</b> 800 <b>RWOS90-7</b> 900 <b>RWOS10-7</b> 1000 MFC Carcase	<b>RWOS30-9</b> 300 <b>RWOS40-9</b> 400 <b>RWOS45-9</b> 450 <b>RWOS50-9</b> 500 <b>RWOS60-9</b> 600 <b>RWOS80-9</b> 800 <b>RWOS90-9</b> 900 <b>RWOS10-9</b> 1000 <b>RDC1/50*</b> 500 <b>RDC1/60*</b> 600 MFC Carcase

**MIDI UNITS**

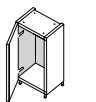
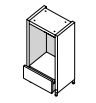
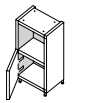
			
<b>H:1250mm</b> CODE     WIDTH	<b>H:1250mm</b> CODE     WIDTH	<b>H:1250mm</b> CODE     WIDTH	<b>H:1250mm</b> CODE     WIDTH
<b>RMLU60</b> 600	<b>RMA160</b> 600	<b>RMD060</b> 600	<b>RMOH560</b> 600



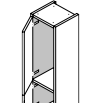
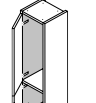
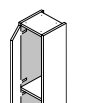
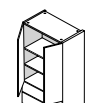
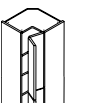
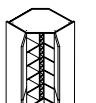
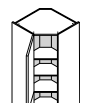

**LARDER**

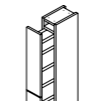
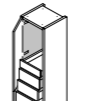
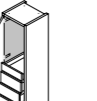
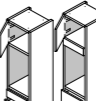
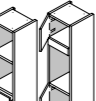
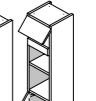
						
<b>H:1970mm</b> CODE     WIDTH	<b>H:2150mm</b> CODE     WIDTH	<b>H:1970mm</b> CODE     WIDTH	<b>H:1970mm</b> CODE     WIDTH	<b>H:1970mm</b> CODE     *H:2150mm WIDTH	<b>H:1970mm</b> CODE     *H:2150mm WIDTH	<b>H:1970mm</b> CODE     *H:2150mm WIDTH
<b>RTL30</b> 300 <b>RETLU30</b> 300 <b>RTL40</b> 400 <b>RETLU40</b> 400 <b>RTL50</b> 500 <b>RETLU50</b> 500 <b>RTL60</b> 600 <b>RETLU60</b> 600 <b>TLU80</b> 800 <b>ETLU80</b> 800 <b>TLU10</b> 1000 <b>ETLU10</b> 1000 <b>RETLU60/1*</b> 600 *715mm bottom, 1425mm top door	<b>RCRTLUSD30</b> 300 <b>RCRTLUSD40</b> 400 <b>RCRTLUSD50</b> 500 <b>RCRTLUSD60</b> 600	<b>TDLU80</b> 800 <b>TDLU10</b> 1000 2x355mm drawers	<b>TCLU98</b> 985x985 <b>ETCLU98*</b> 985x985 Bi-fold hinge system	<b>TDWL1144</b> 1144x1144 <b>ETDWL1144*</b> 1144x1144	<b>TDCLU1003</b> 1003x1003 <b>ETDCLU1003*</b> 1003x1003	



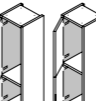
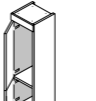
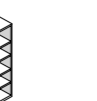

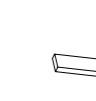
**PULL-OUT LARDER** **INNER DRAWER LARDER** **DOUBLE OVEN** **SINGLE OVEN** **SINGLE OVEN + COMPACT** **COMPACT**

					
<b>H:1970mm</b> CODE     *H:2150mm WIDTH	<b>H:1970mm</b> CODE     WIDTH	<b>H:2150mm</b> CODE     WIDTH	<b>H:1970mm</b> CODE     *H:2150mm WIDTH	<b>H:1970mm</b> CODE     *H:2150mm WIDTH	<b>H:1970mm</b> CODE     *H:2150mm WIDTH
<b>RTISPOL30</b> 300 <b>RTLID30</b> 300 <b>RTKPOL30</b> 300 <b>RTLID40</b> 400 <b>RETISPOL30*</b> 300 <b>RTLID50</b> 500 Standard Mechanism inc. Kessebohrer Mechanism	<b>RETLID30</b> 300 <b>RETLID40</b> 400 <b>RETLID50</b> 500 <b>RETLID60</b> 600 1 x Standard, 4 x Deep drawers	<b>RTOHD60</b> 600 <b>RETLD60</b> 600 <b>RTOHD60*</b> 600 <b>RETLD60*</b> 600	<b>RTOHS60</b> 600 <b>RETSD60</b> 600 <b>RTOHS60*</b> 600 <b>RETSD60*</b> 600	<b>RTOHSC60</b> 600 <b>RETOHSC60*</b> 600	<b>RTOHC60</b> 600 <b>RETOHC60*</b> 600

**TALL FRIDGE/FREEZER** **BOX WINE RACKS** **END SUPPORT PANELS** **CARCASE MFC PANELS** **CORNICE/PELMET** **PLINTH**

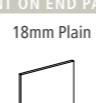
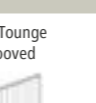
					
<b>H:1970mm</b> CODE     WIDTH	<b>H:2150mm</b> CODE     WIDTH	<b>W:125mm / W:250mm*</b> CODE     HEIGHT	<b>H:900mm</b> CODE     WIDTH	<b>H:18mm</b> CODE     D:70mm	<b>H:150mm</b> CODE     WIDTH     CODE     WIDTH
<b>RTFF1/60</b> 600 <b>RETFF1/60</b> 600 <b>RTFF4/60*</b> 600 <b>RETFF2/60</b> 600 *Doors undrilled <b>RTFF1U/60#</b> 600 <b>RETFF3/60*</b> 600 <b>RTFF4U/60#</b> 600 <b>RETFF1U/60#</b> 600 # For door on door appliances	<b>RWR125-7</b> 720 <b>RWR250-7*</b> 720 <b>RWR125-9</b> 900 <b>RWR250-9*</b> 900 <b>WR125-1210</b> 1210 <b>WR125-1970</b> 1970 <b>WR250-1970</b> 1970 *715mm bottom, 1425mm top door	<b>1970/300</b> 300x1970 <b>2150/560</b> 560x2150 <b>2350/660</b> 660x2350 <b>720/300</b> 300x720 <b>900/2000</b> 2000x900 <b>900/300</b> 300x900 MFC Carcase <b>UG/**ET</b> 1000x22 *Un-Glued 1m Carcase Edging	<b>PCM/MP</b> Painted	<b>PL</b> 2940 Melamine [Carcase MFC] <b>PL/MP</b> 3000 Painted	<b>PST</b> 3000 Clear Sealing Strip

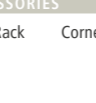
**PLANT ON END PANELS** **PILASTERS** **FURNITURE ACCESSORIES** **INTEGRATED DOORS** **SPARE DOOR FITTINGS** **GENERAL ACCS.**

					
<b>18mm Plain</b>	<b>18mm Tounge &amp; Grooved</b>	<b>Square</b> <b>Chamfered</b>	<b>Door Hung Spice Rack</b>	<b>Corner Post [Spare]</b>	<b>Undrilled</b>
<b>2400/650P/MP</b> 650x2400 <b>800/375P/MP</b> 375x800 <b>900/650P/MP</b> 650x900 <b>960/375P/MP</b> 375x960 <b>900/1200P/MP</b> 1200x900 <b>900/2400P/MP</b> 2400x900 Painted	<b>2400/650T/MP</b> 650x2400 <b>800/375T/MP</b> 375x800 <b>900/650T/MP</b> 650x900 <b>960/375T/MP</b> 375x960 <b>900/1200T/MP</b> 1200x900 <b>900/2200T/MP</b> 2200x900 Painted	<b>H:900mm/2400mm*</b> CODE     WXD <b>PIL/S2400MP*</b> 50x75 <b>PIL/S900MP</b> 68x68 Square Painted <b>PIL/SC900MP</b> 68x68 Chamfered Painted	<b>H:1050mm</b> CODE     WXD <b>DHSR/BNO</b> 350x106	<b>H:715mm</b> CODE     WIDTH <b>CP/MP**</b> 146 Painted	<b>CODE</b> WXH <b>INT4571</b> 446x715 <b>INT6071</b> 596x715
			<b>Stay [Blum</b>		



J-HANDLE  
PRICE GROUP 4  
**METZ GLOSS**

*Special sizes available*  
contact us for further information

Colours Options [PG4]: Graphite, Light Grey, Savanna, and White.



**HI-LINE BASE**

CODE	WIDTH	CODE	WIDTH
RBA15	150	R2BA60*	600
RBA26	260	RBA70#	700
RBA30	300	RBA80#	800
RBA35	350	RBA90#	900
RBA40	400	RBA10#	1000
RBA45	450	RBA12#	1200
RBA50	500	*No muntin [2x300 doors]	
RBA60	600	# 2 x Doors	

**Pull-Out**

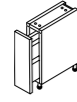

CODE	WIDTH
RBISPO15	150
Standard Mechanism inc.	
RBKTP015 150	
Kesseböhmer Mechanism inc.	
RBKTP015 150	
Kesseböhmer Mechanism & Towel rail inc.	

**Curved Return [300mm deep]**



CODE	WIDTH
RCRBA26	260

**Curved Door**



CODE	WIDTH
RCDRBA30	300x300

**Splayed**

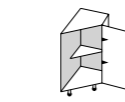

CODE	WIDTH
RABA360	360

**LOW BASE**

**Shallow Base [300mm deep]**

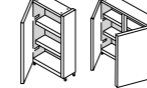

CODE	WIDTH
R2WU60-9	600x600
Add 'X' to the end of the code for 350mm deep [650x650]	

**'L' Shaped Corner**

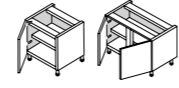

CODE	WIDTH
RCWL60-9	600x600
Add 'X' to the end of the code for 350mm deep [650x650]	

**TALL WALL**



CODE	WIDTH
RCWD60-9	600x600
Add 'X' to the end of the code for 350mm deep [650x650]	

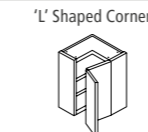

CODE	WIDTH
R2WU60-9	600x600
Add 'X' to the end of the code for 350mm deep [650x650]	

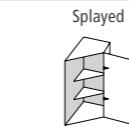

CODE	WIDTH
RAWU360-9	360
Add 'X' to the end of the code for 350mm deep	

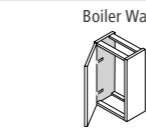

CODE	WIDTH
RHWU5029	500
RHWU6029	600
RHWU8029	800
RHWU9029	900
RHWU1029	1000
RHWU5036	500
RHWU6036	600
RHWU8036	800
RHWU9036	900
RHWU1036	1000
Add 'X' to the end of the code for 350mm deep	

**HORIZONTAL WALL**

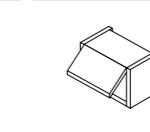

CODE	WIDTH
RWOS50-2	500
RWOS60-2	600
RWOS80-2	800
RWOS90-2	900
RWOS10-2	1000
MFC Carcase	
If 350mm deep carcase is required adjust code, e.g. RWOS1035-2	

**OPEN WALL**

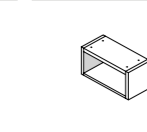

CODE	WIDTH
RWOS50-3	500
RWOS60-3	600
RWOS80-3	800
RWOS90-3	900
RWOS10-3	1000
MFC Carcase	
If 350mm deep carcase is required adjust code, e.g. RWOS1035-3	

**OPEN WALL**

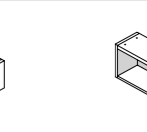

CODE	WIDTH
RWOS50-5	500
RWOS60-5	600
RWOS80-5	800
RWOS90-5	900
RWOS10-5	1000
MFC Carcase	
If 350mm deep carcase is required adjust code, e.g. RWOS1035-5	

**OPEN WALL**

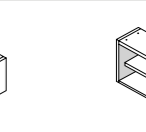

CODE	WIDTH
RWOS30-5	300
RWOS40-5	400
RWOS45-5	450
RWOS50-5	500
RWOS60-5	600
RWOS80-5	800
RWOS90-5	900
RWOS10-5	1000
MFC Carcase	
If 350mm deep carcase is required adjust code, e.g. RWOS1035-5	

**HI-LINE CORNER BASE**

CODE	WIDTH	CODE	WIDTH
RBAC830	800/300	RBAC950	900/500
RBAC80	800/400	RBAC960	900/600
RBAC845	800/450	RBAC140	1000/400
RBAC850	800/500	RBAC145	1000/450
RBAC860	800/600	RBAC10	1000/500
RBAC940	900/400	RBAC160	1000/600
RBAC945	900/450	RBAC12	1200/600
Inc. 60x60mm Corner Post & Blanking Panel			

**'L' Shaped**

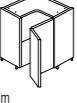

CODE	WIDTH
BAC90	900x900
Bi-fold hinge system	
Flatpack	

**Diagonal**



CODE	WIDTH
CDA90	900x900
Flatpack	

**DRAWERLINE BASE**



CODE	WIDTH	CODE	WIDTH
RBD30	300	RBD80#	800
RBD40	400	RBD90#	900
RBD45	450	RBD10#	1000
RBD50	500	RBD12#	1200
RBD60	600	# 2 x Doors	

**DRAWERLINE SINK BASE**



CODE	WIDTH	CODE	WIDTH
RBD80/1	800	RBD50	500
RBD90/1	900	RBD60	600
RBD10/1	1000	RBD12	1200
RBD11	1100	RBD12*	1200
RBD12	1200	RBD12**	1200
*One working drawer			
**2 x Doors			

**CERAMIC SINK BASE**

CODE	WIDTH	CODE	WIDTH
RBSU60	600	RBDC830	800/300
To suit a sink height of 260mm			
RBDC80 800/400			
RBDC845 800/450			
RBDC850 800/500			
RBDC860 800/600			
RBDC860 800/600			
RBDC12 1200/600			
Inc. 60x60mm Corner Post & Blanking Panel			

**DRAWERLINE CORNER BASE**



CODE	WIDTH
RBAC140	1000/400
RBAC145	1000/450
RBAC10	1000/500
RBAC160	1000/600
RBAC12	1200/600

**BUILT UNDER**

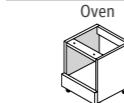

CODE	WIDTH
RBU060	600

**Microwave**

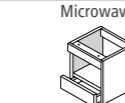

CODE	WIDTH
RBUM60	600
175mm drawer & 110mm filler	

**2 DRAWER BASE**

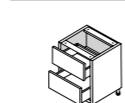

CODE	WIDTH
RBD250	500
RBD260	600
RBD280	800
RBD290	900
RBD210	1000
2x355mm Drawers	

**3 DRAWER BASE**

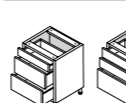

CODE	WIDTH
RBD350/175	500
RBD360/175	600
2x175mm, 1x355mm Drawers	

**4 DRAWER BASE**

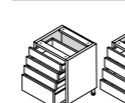

CODE	WIDTH
RBD450/175	500
RBD460/175	600
4x175mm Drawers	

**5 DRAWER BASE**

CODE	WIDTH
RBD530	300
RBD540	400
RBD545	450
RBD550	500
RBD560	600
RBD580	800
RBD590	900
RBD510	1000
5x140mm Drawers	

**LOW WALL**

CODE	WIDTH
RWU30-5	300
RWU40-5	400
RWU45-5	450
RWU50-5	500
RWU60-5	600
R2WU60-5*	600
RWU80-5*	800
*No muntin [2x300 doors]	
# 2 x Doors	
Add 'X' to the end of the code for 350mm deep	

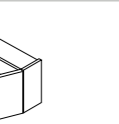

CODE	WIDTH
RCWD60-5	600x600
Add 'X' to the end of the code for 350mm deep [650x650]	



CODE	WIDTH
RAWU360-5	360
Add 'X' to the end of the code for 350mm deep	

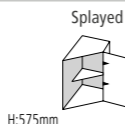

CODE	WIDTH
RWU26-7	260
RWU30-7	300
RWU35-7	350
RWU40-7	400
RWU45-7	450
RWU50-7	500
RWU60-7	600
# 2xDoors	
Add 'X' to the end of the code for 350mm deep	

**MEDIUM WALL**

CODE	WIDTH
RWU26-7	260
RWU30-7	300
RWU35-7	350
RWU40-7	400
RWU45-7	450
RWU50-7	500
RWU60-7	600
# 2xDoors	
Add 'X' to the end of the code for 350mm deep	

CODE	WIDTH
R2WU60-7*	600
RWU70-7#	700
RWU80-7#	800
RWU90-7#	900
RWU10-7#	1000
*No muntin [2x300 doors]	
# 2xDoors	
Add 'X' to the end of the code for 350mm deep	

CODE	WIDTH
RCWD60-7	600x600
Add 'X' to the end of the code for 350mm deep [650x650]	

**MEDIUM WALL**

CODE	WIDTH
RCWL60-7	600x600
Bi-fold hinge system	
Add 'X' to the end of the code for 350mm deep [650x650]	

**Conventional Corner**

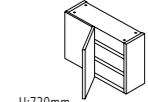

CODE	WIDTH
RWUC60-7	600
300 Door	
RWUC260-7 600	
260 Door	
Inc. 60x60mm Corner Post	
Add 'X' to the end of the code for 350mm deep	

**Splayed**

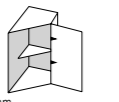

CODE	WIDTH
RAWU360-7	360
Add 'X' to the end of the code for 350mm deep	

**Curved Door**

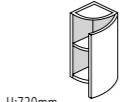

CODE	WIDTH
RCDWU30-7	300x300

**Microwave Wall**

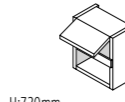

CODE	WIDTH
RMWU60-7	600
283mm flap, 110mm filler; Mechanism inc.	
Add 'X' to the end of the code for 350mm deep	

**Bi-Fold**

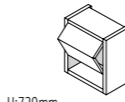

CODE	WIDTH
RBFWU60-7	600
RBFWU80-7	800
RBFWU90-7	900
RBFWU10-7	1000
Mechanism inc.	
Add 'X' to the end of the code for 350mm deep	

**TALL WALL**

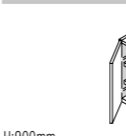

CODE	WIDTH
RWU30-9	300
RWU40-9	400
RWU45-9	450
RWU50-9	500
RWU60-9	600
*No muntin [2x300 doors]	
# 2xDoors	
Add 'X' to the end of the code for 350mm deep	

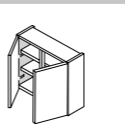

CODE	WIDTH
R2WU60-9*	600
RWU80-9#	800
RWU90-9#	900
RWU10-9#	1000
*No muntin [2x300 doors]	
# 2xDoors	
Add 'X' to the end of the code for 350mm deep	

**OPEN WALL**

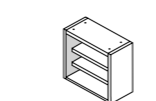

CODE	WIDTH
RWOS30-7	300
RWOS40-7	400
RWOS45-7	450
RWOS50-7	500
RWOS60-7	600
RWOS80-7	800
RWOS90-7	900
RWOS10-7	1000
MFC Carcase	
If 350mm deep carcase is required adjust code, e.g. RWOS1035-7	

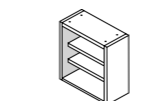

CODE	WIDTH
RWOS30-9	300
RWOS40-9	400
RWOS45-9	450
RWOS50-9	500
RWOS60-9	600
RWOS80-9	800
RWOS90-9	900
RWOS10-9	1000
MFC Carcase	
If 350mm deep carcase is required adjust code, e.g. RWOS1035-9	

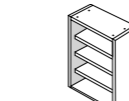

CODE	WIDTH
RDC1/50	500
RDC1/60	600
MFC Carcase	

J-HANDLE  
PRICE GROUP 4  
**METZ MATT**

Special sizes available  
contact us for further information

Colours Options [PG4]: Dust, Fog, Graphite, Light Grey and Savanna.



HI-LINE BASE LOW BASE HI-LINE CORNER BASE

**HI-LINE BASE**

**Pull-Out**

H:720mm  
CODE WIDTH CODE WIDTH  
RBA15 150 RBA60\* 600  
RBA26 260 RBA70# 700  
RBA30 300 RBA80# 800  
RBA35 350 RBA90# 900  
RBA40 400 RBA10# 1000  
RBA45 450 RBA12# 1200  
RBA50 500 \*No muntin [2x300 doors]  
RBA60 600 #2 x Doors

**Curved Door**

H:720mm  
CODE WIDTH  
RCRBA30 300x300

**Shallow Base [300mm deep]**

H:720mm  
CODE WIDTH  
RSBU30 300  
RSBU35 350  
RSBU40 400  
RSBU45 450  
RSBU50 500  
RSBU60 600  
RSBU70# 700  
RSBU80# 800  
RSBU90# 900  
RSBU10# 1000  
#2 x Doors

**Splayed**

H:720mm  
CODE WIDTH  
RABA360 360

**Curved Return [300mm deep]**

H:720mm  
CODE WIDTH  
RCRBA26 260

**LOW BASE**

H:575mm  
CODE WIDTH  
RLBU30 300  
RLBU40 400  
RLBU45 450  
RLBU50 500  
RLBU60 600  
RLBU80# 800  
RLBU90# 900  
RLBU10# 1000  
#2 x Doors

**HI-LINE CORNER BASE**

H:720mm  
CODE WIDTH CODE WIDTH  
RBAC830 800/300 RBAC950 900/500  
RBAC80 800/400 RBAC960 900/600  
RBAC845 800/450 RBAC140 1000/400  
RBAC850 800/500 RBAC145 1000/450  
RBAC860 800/600 RBAC10 1000/500  
RBAC940 900/400 RBAC160 1000/600  
RBAC945 900/450 RBAC12 1200/600  
Inc. 60x60mm Corner Post & Blanking Panel

HI-LINE CORNER BASE DRAWERLINE BASE DRAWERLINE SINK BASE CERAMIC SINK BASE

**HI-LINE CORNER BASE**

**'L' Shaped**

H:720mm  
CODE WIDTH CODE WIDTH  
BAC90 900x900  
Bi-fold hinge system Flatpack

**Diagonal**

H:720mm  
CODE WIDTH  
CDA90 900x900  
Flatpack

**DRAWERLINE BASE**

H:720mm  
CODE WIDTH CODE WIDTH  
RBD30 300 RBD80# 800  
RBD40 400 RBD90# 900  
RBD45 450 RBD10# 1000  
RBD50 500 RBD12# 1200  
RBD60 600 #2 x Doors

**Single Top Drawer**

H:720mm  
CODE WIDTH  
RBD80/1 800  
RBD90/1 900  
RBD10/1 1000

**DRAWERLINE SINK BASE**

H:720mm  
CODE WIDTH CODE WIDTH  
RBDF50 300 RBDF80# 450  
RBDF60 400 RBDF90# 500  
RBDF10# 600  
RBD10#\* 800  
RBD12#\* 900  
\*One working drawer #2 x Doors

**CERAMIC SINK BASE**

H:460mm  
CODE WIDTH  
RBSU60 600  
To suit a sink height of 260mm

DRAWERLINE CORNER BASE BUILT UNDER 2 DRAWER BASE 3 DRAWER BASE 4 DRAWER BASE 5 DRAWER BASE

**DRAWERLINE CORNER BASE**

H:720mm  
CODE WIDTH CODE WIDTH  
RBD C830 800/300 RBD C140 1000/400  
RBD C80 800/400 RBD C145 1000/450  
RBD C845 800/450 RBD C10 1000/500  
RBD C850 800/500 RBD C160 1000/600  
RBD C860 800/600 RBD C12 1200/600  
Inc. 60x60mm Corner Post & Blanking Panel

**BUILT UNDER**

**Oven**

H:720mm  
CODE WIDTH  
RBU060 600

**Microwave**

H:720mm  
CODE WIDTH  
RBUM60 600  
175mm drawer & 110mm filler

**2 DRAWER BASE**

H:720mm  
CODE WIDTH  
RBD250 500  
RBD260 600  
RBD280 800  
RBD290 900  
RBD310 1000  
2x355mm Drawers

**3 DRAWER BASE**

H:720mm  
CODE WIDTH  
RBD350 500  
RBD360 600  
RBD380 800  
RBD390 900  
RBD410 1000  
1x140mm, 2x283mm Drawers

**4 DRAWER BASE**

H:720mm  
CODE WIDTH  
RBD450 500  
RBD460 600  
RBD480 800  
RBD490 900  
RBD410 1000  
3x140mm, 1x283mm Drawers

**5 DRAWER BASE**

H:720mm  
CODE WIDTH  
RBD530 300  
RBD540 400  
RBD545 450  
RBD550 500  
RBD560 600  
RBD580 800  
RBD590 900  
RBD510 1000  
5x140mm Drawers

LOW WALL MEDIUM WALL TALL WALL

**LOW WALL**

**Diagonal Corner**

H:575mm  
CODE WIDTH CODE WIDTH  
RWU30-5 300 RWU90-5\* 900  
RWU40-5 400 RWU10-5\* 1000  
RWU45-5 450 \*No muntin [2x300 doors]  
RWU50-5 500 #2 x Doors  
RWU60-5 600 Add 'X' to the end of the code for 350mm deep  
R2WU60-5\* 600  
RWU80-5\* 800

**Splayed**

H:575mm  
CODE WIDTH  
RCWD60-5 600x600  
Add 'X' to the end of the code for 350mm deep [650x650]

**Diagonal Corner**

H:720mm  
CODE WIDTH CODE WIDTH  
RWU26-7 260 R2WU60-7\* 600  
RWU30-7 300 RWU70-7# 700  
RWU35-7 350 RWU80-7# 800  
RWU40-7 400 RWU90-7# 900  
RWU45-7 450 RWU10-7# 1000  
RWU50-7 500 \*No muntin [2x300 doors]  
RWU60-7 600 #2xDoors  
Add 'X' to the end of the code for 350mm deep

**'L' Shaped Corner**

H:720mm  
CODE WIDTH  
RCWL60-7 600x600  
Bi-fold hinge system  
Add 'X' to the end of the code for 350mm deep [650x650]

**MEDIUM WALL**

**Conventional Corner**

H:720mm  
CODE WIDTH CODE WIDTH  
RWUC60-7 600 RAWU360-7 360  
300 Door Add 'X' to the end of the code for 350mm deep  
RWUC260-7 600

**Splayed**

H:720mm  
CODE WIDTH  
RCWDU30-7 300x300

**Curved Door**

H:720mm  
CODE WIDTH  
RMWU60-7 600  
283mm flap, 110mm filler; Mechanism inc.

**Microwave Wall**

H:720mm  
CODE WIDTH  
RBFU60-7 600  
283mm flap, 110mm filler; Mechanism inc.

**Bi-Fold**

H:720mm  
CODE WIDTH  
RBFU80-7 800  
RBFU90-7 900  
RBFU10-7 1000  
Mechanism inc.

**Diagonal Corner**

H:900mm  
CODE WIDTH CODE WIDTH  
RWU30-9 300 R2WU60-9\* 600  
RWU40-9 400 RWU80-9# 800  
RWU45-9 450 RWU90-9# 900  
RWU50-9 500 RWU10-9# 1000  
RWU60-9 600 \*No muntin [2x300 doors]  
#2xDoors  
Add 'X' to the end of the code for 350mm deep

MEDIUM WALL TALL WALL

**MEDIUM WALL**

**Conventional Corner**

H:720mm  
CODE WIDTH CODE WIDTH  
RWUC60-7 600 RAWU360-7 360  
300 Door Add 'X' to the end of the code for 350mm deep  
RWUC260-7 600

**Splayed**

H:720mm  
CODE WIDTH  
RCWDU30-7 300x300

**Curved Door**

H:720mm  
CODE WIDTH  
RMWU60-7 600  
283mm flap, 110mm filler; Mechanism inc.

**Microwave Wall**

H:720mm  
CODE WIDTH  
RBFU60-7 600  
283mm flap, 110mm filler; Mechanism inc.

**Bi-Fold**

H:720mm  
CODE WIDTH  
RBFU80-7 800  
RBFU90-7 900  
RBFU10-7 1000  
Mechanism inc.

**Diagonal Corner**

H:900mm  
CODE WIDTH CODE WIDTH  
RWU30-9 300 R2WU60-9\* 600  
RWU40-9 400 RWU80-9# 800  
RWU45-9 450 RWU90-9# 900  
RWU50-9 500 RWU10-9# 1000  
RWU60-9 600 \*No muntin [2x300 doors]  
#2xDoors  
Add 'X' to the end of the code for 350mm deep

**TALL WALL**

**Conventional Corner**

H:900mm  
CODE WIDTH CODE WIDTH  
RWC60-9 600 RAWU360-9 360  
400 Door Add 'X' to the end of the code for 350mm deep  
RWC260-9 600

**Splayed**

H:900mm  
CODE WIDTH  
RCWDU30-9 300x300

**Curved Door**

H:900mm  
CODE WIDTH  
RMWU60-9 600  
283mm flap, 110mm filler; Mechanism inc.

**Microwave Wall**

H:900mm  
CODE WIDTH  
RBFU60-9 600  
283mm flap, 110mm filler; Mechanism inc.

**Bi-Fold**

H:900mm  
CODE WIDTH  
RBFU80-9 800  
RBFU90-9 900  
RBFU10-9 1000  
Mechanism inc.

**Diagonal Corner**

H:1200mm  
CODE WIDTH CODE WIDTH  
RWC30-12 300 R2WC60-12\* 600  
RWC40-12 400 RWC80-12# 800  
RWC45-12 450 RWC90-12# 900  
RWC50-12 500 RWC10-12# 1000  
RWC60-12 600 \*No muntin [2x300 doors]  
#2xDoors  
Add 'X' to the end of the code for 350mm deep

TALL WALL HORIZONTAL WALL OPEN WALL

**TALL WALL**

**'L' Shaped Corner**

H:900mm  
CODE WIDTH  
RCWL60-9 600x600  
Add 'X' to the end of the code for 350mm deep [650x650]

**Splayed**

H:900mm  
CODE WIDTH  
RAWU360-9 360  
Add 'X' to the end of the code for 350mm deep

**Boiler Wall**

H:900mm  
CODE WIDTH  
BWU6040-9 600  
400mm Deep Flatpack

**HORIZONTAL WALL**

H:290mm  
CODE WIDTH CODE WIDTH  
RHWU5029 500 RHWU5036 500  
RHWU6029 600 RHWU6036 600  
RHWU8029 800 RHWU8036 800  
RHWU9029 900 RHWU9036 900  
RHWU1029 1000 RHWU1036 1000  
Add 'X' to the end of the code for 350mm deep

H:360mm  
CODE WIDTH  
RHWU5036 500  
RHWU6036 600  
RHWU8036 800  
RHWU9036 900  
RHWU1036 1000

**OPEN WALL**

H:290mm  
CODE WIDTH  
RWOS50-2 500  
RWOS60-2 600  
RWOS80-2 800  
RWOS90-2 900  
RWOS10-2 1000  
MFC Carcase

H:360mm  
CODE WIDTH  
RWOS50-3 500  
RWOS60-3 600  
RWOS80-3 800  
RWOS90-3 900  
RWOS10-3 1000  
MFC Carcase

H:575mm  
CODE WIDTH  
RWOS30-5 300  
RWOS40-5 400  
RWOS45-5 450  
RWOS50-5 500  
RWOS60-5 600  
RWOS80-5 800  
RWOS90-5 900  
RWOS10-5 1000  
MFC Carcase

If 350mm deep carcase is required adjust code, e.g. RWOS1035-2

If 350mm deep carcase is required adjust code, e.g. RWOS1035-3

If 350mm deep carcase is required adjust code, e.g. RWOS1035-5

OPEN WALL MIDI UNITS LARDER

**OPEN WALL**

H:720mm  
CODE WIDTH  
RWOS30-7 300  
RWOS40-7 400  
RWOS45-7 450  
RWOS50-7 500  
RWOS60-7 600  
RWOS80-7 800  
RWOS90-7 900  
RWOS10-7 1000  
MFC Carcase

H:900mm  
CODE WIDTH  
RWOS30-9 300  
RWOS40-9 400  
RWOS45-9 450  
RWOS50-9 500  
RWOS60-9 600  
RWOS80-9 800  
RWOS90-9 900  
RWOS10-9 1000  
MFC Carcase

H:1210mm  
CODE WIDTH  
RDC1/50 500  
RDC1/60 600  
MFC Carcase

If 350mm deep carcase is required adjust code, e.g. RDC1/3550

**MIDI UNITS**

H:1250mm  
CODE WIDTH  
RMLU60 600  
RMA160 600

H:1250mm  
CODE WIDTH  
RMD060 600  
RMOH560 600

**LARDER**

H:1970mm  
CODE WIDTH  
RTL30 300  
RTL40 400  
RTL50 500  
RTL60 600  
TLU80 800  
TLU10 1000

H:2150mm  
CODE WIDTH  
RETL30 300  
RETL40 400  
RETL50 500  
RETL60 600  
ETLU80 800  
ETLU10 1000

H:1970mm  
CODE WIDTH  
TDLU80 800  
TDLU10 1000  
2x355mm drawers

LARDER PULL-OUT LARDER INNER DRAWER LARDER DOUBLE OVEN SINGLE OVEN SINGLE OVEN + COMPACT

**LARDER**

**Diagonal Walk-in Larder**

H:1970mm \*H:2150mm  
CODE WIDTH CODE WIDTH  
TDWL1144 1144x1144  
ETDWL1144\* 1144x1144

**Diagonal**

H:1970mm \*H:2150mm  
CODE WIDTH CODE WIDTH  
TDCLU1003 1003x1003  
ETDCLU1003\* 1003x1003

**PULL-OUT LARDER**

H:1970mm \*H:2150mm  
CODE WIDTH CODE WIDTH  
RTLID30 300  
RTLID40 400  
RTLID50 500  
RTLID60 600

**INNER DRAWER LARDER**

H:1970mm \*H:2150mm  
CODE WIDTH CODE WIDTH  
RETLID30 300  
RETLID40 400  
RETLID50 500  
RETLID60 600  
1 x Standard, 4 x Deep drawers

**DOUBLE OVEN**

H:1970mm \*H:2150mm  
CODE WIDTH CODE WIDTH  
RTOHD60 600  
RTOHDD60 600  
RETOHDD60\* 600

**SINGLE OVEN**

H:1970mm \*H:2150mm  
CODE WIDTH CODE WIDTH  
RTOHS60 600  
RTOHSD60 600  
RETOHS60\* 600

**SINGLE OVEN + COMPACT**

H:1970mm \*H:2150mm  
CODE WIDTH CODE WIDTH  
RTOHSC60 600  
RETOHSC60\* 600

COMPACT TALL FRIDGE/FREEZER BOX WINE RACKS END SUPPORT PANELS CARCASE MFC PANELS

**COMPACT**

H:1970mm \*H:2150mm  
CODE WIDTH CODE WIDTH  
RTOHC60 600  
RETOHC60\* 600

**TALL FRIDGE/FREEZER**

H:1970mm \*H:2150mm  
CODE WIDTH CODE WIDTH  
RTFF1/60 600  
RTFF4/60\* 600  
\*Doors undrilled  
RTFF10/60# 600  
RTFF40/60# 600  
#For door on door appliances

H:2150mm  
CODE WIDTH CODE WIDTH  
RETFF1/60 600  
RETFF2/60 600  
RETFF10/60# 600  
RETFF20/60# 600  
#For door on door appliances

**BOX WINE RACKS**

W:125mm / W:250mm\*  
H:1970mm \*H:2150mm  
CODE HEIGHT CODE HEIGHT  
RWR125-7 720  
RWR250-7\* 720  
RWR125-9 900  
RWR250-9\* 900  
MFC Carcase

**END SUPPORT PANELS**

H:900mm  
CODE WIDTH CODE WXH  
ESP 600  
900/700 700  
MFC Carcase

**CARCASE MFC PANELS**

H:900mm  
CODE WXH CODE WXH  
1970/300 300x1970  
2150/560 560x2150  
2350/660 660x2350  
720/300 300x720  
900/2000 2000x900  
900/300 300x900  
MFC Carcase

\*Un-Glued 1m carcase edging

CORNICE / PELMET PLINTH PLANT ON END PANELS

**CORNICE / PELMET**

**Curved Combi Section**

H:28mm  
CODE LENGTH  
CM/MM 3000  
Matt

**Curved Plinth Section**

H:28mm  
CODE WIDTH  
CCMS/MM 323x323  
Matt  
Use in conjunction with CM/MM

**Clear Sealing Strip**

H:150mm  
CODE WIDTH  
PL 2940  
Melamine [Carcase MFC]  
PL/MM 3000  
Matt

**PLANT ON END PANELS**

18mm  
CODE WXH CODE WXH  
2400/650/18MM 650x2400  
780/375/18MM 375x780  
900/650/18MM 650x900  
960/375/18MM 375x960  
Matt

18mm Breakfast Bar Panel  
CODE WXH  
900/2400/18MM 2400x900  
Matt

Corner Post [Spare]  
H:715mm  
CODE WIDTH  
CP/MM 60x60  
Matt

FURNITURE ACCESSORIES INTEGRATED DOORS SPARE DOOR FITTINGS GENERAL ACCS.

**FURNITURE ACCESSORIES**

**External Corner Post**

W:72mm  
CODE HEIGHT  
ECP7/MM 715  
ECP9/MM 900  
Matt

**External Radius Corner Post**

H:900mm  
CODE WIDTH  
ERCP/MM 80  
Matt

**Radius End Post**

H:2400mm  
CODE WXD  
RP/MM 88x128  
Matt

**Radius End Post Caps - Combi**

H:28mm  
CODE  
RPCMC/MM  
Matt  
Use in conjunction with RP/MM

**INTEGRATED DOORS**

**Undrilled**

CODE WXH  
INT4571 446x715  
INT6071 596x715

**SPARE DOOR FITTINGS**

**Hinges [Hettich Soft Close]**

CODE  
SCHINGE90 90 degree [Pair]  
SCHINGE170 170 degree [Pair]

**Stays [Blum Aventos]**

CODE  
BLSTAYHKS\* HK-S stay [Pair]  
\*[Inc mounting brackets]

**GENERAL ACCS.**

CODE  
STPWN Set of 2  
Door Strapping Plates  
LEGSET Set of 4  
Adjustable legs  
SACC Pk 50  
14mm Self Adhesive  
Cover Caps  
PCC/MM  
Painted Care Kit

Note: Furniture codes beginning with the letter 'R' are assembled (rigid), by removing the 'R' the units are supplied unassembled (flat-pack).

Note: Furniture codes beginning with the letter 'R' are assembled (rigid), by removing the 'R' the units are supplied unassembled (flat-pack).



J-HANDLE  
PRICE GROUP 4  
**SARAYA GLOSS**

Special sizes available  
contact us for further information

Colours Options (PG4): Ash and White.



**HI-LINE BASE**

Pull-Out		Curved Door		Curved Return [300mm deep]		Splayed	
H:720mm CODE	WIDTH	H:720mm CODE	WIDTH	H:720mm CODE	WIDTH	H:720mm CODE	WIDTH
RBA15	150	RZBA60*	600	RBISPO15	150	RABU30	300
RBA26	260	RBA70#	700	Standard Mechanism inc.		RSBU35	350
RBA30	300	RBA80#	800	RBKPO15	150	RSBU40	400
RBA35	350	RBA90#	900	Kesseböhmer Mechanism inc.		RSBU45	450
RBA40	400	RBA10#	1000	RBKTP015	150	RSBU50	500
RBA45	450	RBA12#	1200	Kesseböhmer Mechanism & Towel rail inc.		RSBU60	600
RBA50	500						
RBA60	600						

**LOW BASE**

HI-LINE CORNER BASE		DRAWERLINE BASE	
H:720mm CODE	WIDTH	H:720mm CODE	WIDTH
RBAC830	800/300	RBD30	300
RBAC80	800/400	RBD40	400
RBAC845	800/450	RBD45	450
RBAC850	800/500	RBD50	500
RBAC860	800/600	RBD60	600
RBAC940	900/400		
RBAC945	900/450		

**DRAWERLINE SINK BASE**

H:720mm CODE	WIDTH	H:460mm CODE	WIDTH
RBD50	500	RBSU60	600
RBD60	600		
RBD70	700		
RBD80	800		
RBD90	900		
RBD100	1000		
RBD110	1100		
RBD120	1200		

**4 DRAWER BASE**

H:720mm CODE	WIDTH	H:720mm CODE	WIDTH
RBD450	500	RBD530	300
RBD460	600	RBD540	400
RBD480	800	RBD545	450
RBD490	900	RBD550	500
RBD410	1000	RBD560	600
RBD450/175	500	RBD580	800
RBD460/175	600	RBD590	900
		RBD510	1000

**MEDIUM WALL**

H:720mm CODE	WIDTH	H:720mm CODE	WIDTH
RWU30-7	300	RWU40-5	400
RWU40-7	400	RWU45-5	450
RWU45-7	450	RWU50-5	500
RWU50-7	500	RWU60-5	600
RWU60-7	600		

H:900mm CODE	WIDTH	H:900mm CODE	WIDTH
RWU30-9	300	RWU40-9	400
RWU40-9	400	RWU45-9	450
RWU45-9	450	RWU50-9	500
RWU50-9	500	RWU60-9	600

H:290mm CODE	WIDTH	H:360mm CODE	WIDTH
RWOS50-2	500	RWOS50-3	500
RWOS60-2	600	RWOS60-3	600
RWOS80-2	800	RWOS80-3	800
RWOS90-2	900	RWOS90-3	900
RWOS10-2	1000	RWOS10-3	1000

H:2150mm CODE	WIDTH	H:1970mm CODE	WIDTH
RETU30	300	RTID30	300
RETU40	400	RTID40	400
RETU50	500	RTID50	500
RETU60	600	RTID60	600

H:1970mm CODE	WIDTH	H:1970mm CODE	WIDTH
RTOHDD60	600	RTOH560	600
RTOHDD60*	600	RETOH560*	600

H:900mm CODE	WIDTH	H:25mm CODE	LENGTH
ESP	600	PCM/BG	3000
900/700	700	CCMS/BG	322x322
		PL	2940
		PL/BG	3000

22mm	22mm Breakfast Bar Panel	Corner Post [Spare]	External Corner Post
2440/350/22BG	900/2400/22BG	CP/BG	ECP/BG
2440/650/22BG			
900/650/22BG			
910/1185/22BG			
950/350/22BG			

Note: Furniture codes beginning with the letter 'R' are assembled (rigid), by removing the 'R' the units are supplied unassembled (flat-pack).

Note: Furniture codes beginning with the letter 'R' are assembled (rigid), by removing the 'R' the units are supplied unassembled (flat-pack).

J-HANDLE  
PRICE GROUP 4  
**SARAYA MATT**

Special sizes available  
contact us for further information

Colours Options [PG4]: Ash, Cloud, Graphite and White.



**HI-LINE BASE**

Pull-Out		Curved Door		Curved Return [300mm deep]		Splayed	
H:720mm CODE	WIDTH	H:720mm CODE	WIDTH	H:720mm CODE	WIDTH	H:720mm CODE	WIDTH
RBA15	150	RBA15	150	RBA15	150	RBA15	150
RBA26	260	RBA26	260	RBA26	260	RBA26	260
RBA30	300	RBA30	300	RBA30	300	RBA30	300
RBA35	350	RBA35	350	RBA35	350	RBA35	350
RBA40	400	RBA40	400	RBA40	400	RBA40	400
RBA45	450	RBA45	450	RBA45	450	RBA45	450
RBA50	500	RBA50	500	RBA50	500	RBA50	500
RBA60	600	RBA60	600	RBA60	600	RBA60	600

**LOW BASE**

L' Shaped		Diagonal		Single Top Drawer	
H:720mm CODE	WIDTH	H:720mm CODE	WIDTH	H:720mm CODE	WIDTH
RLBU30	300	RLBU30	300	RLBU30	300
RLBU40	400	RLBU40	400	RLBU40	400
RLBU45	450	RLBU45	450	RLBU45	450
RLBU50	500	RLBU50	500	RLBU50	500
RLBU60	600	RLBU60	600	RLBU60	600
RLBU80	800	RLBU80	800	RLBU80	800
RLBU90	900	RLBU90	900	RLBU90	900
RLBU10	1000	RLBU10	1000	RLBU10	1000
RLBU12	1200	RLBU12	1200	RLBU12	1200

**DRAWERLINE SINK BASE**

Oven		Microwave	
H:720mm CODE	WIDTH	H:720mm CODE	WIDTH
RBD50	500	RBD50	500
RBD60	600	RBD60	600
RBD70	700	RBD70	700
RBD80	800	RBD80	800
RBD90	900	RBD90	900
RBD10	1000	RBD10	1000
RBD11	1100	RBD11	1100
RBD12	1200	RBD12	1200

**4 DRAWER BASE**

Diagonal Corner		Splayed	
H:720mm CODE	WIDTH	H:720mm CODE	WIDTH
RBD450	500	RBD450	500
RBD460	600	RBD460	600
RBD480	800	RBD480	800
RBD490	900	RBD490	900
RBD410	1000	RBD410	1000
RBD450/175	500	RBD450/175	500
RBD460/175	600	RBD460/175	600

**MEDIUM WALL**

Glazed		Diagonal Corner		'L' Shaped Corner		Conventional Corner		Splayed		Curved Door		Microwave Wall		Bi-Fold	
H:720mm CODE	WIDTH	H:720mm CODE	WIDTH	H:720mm CODE	WIDTH	H:720mm CODE	WIDTH	H:720mm CODE	WIDTH	H:720mm CODE	WIDTH	H:720mm CODE	WIDTH	H:720mm CODE	WIDTH
RWU50-7	500	RWU50-7	500	RWU50-7	500	RWU50-7	500	RWU50-7	500	RWU50-7	500	RWU50-7	500	RWU50-7	500
RWU10-7	1000	RWU10-7	1000	RWU10-7	1000	RWU10-7	1000	RWU10-7	1000	RWU10-7	1000	RWU10-7	1000	RWU10-7	1000

Note: Furniture codes beginning with the letter 'R' are assembled (rigid), by removing the 'R' the units are supplied unassembled (flat-pack).

**TALL WALL** **HORIZONTAL WALL**

Diagonal Corner		'L' Shaped Corner		Splayed		Boiler Wall	
H:900mm CODE	WIDTH	H:900mm CODE	WIDTH	H:900mm CODE	WIDTH	H:900mm CODE	WIDTH
RWU30-9	300	RWU30-9	300	RWU30-9	300	RWU30-9	300
RWU40-9	400	RWU40-9	400	RWU40-9	400	RWU40-9	400
RWU45-9	450	RWU45-9	450	RWU45-9	450	RWU45-9	450
RWU50-9	500	RWU50-9	500	RWU50-9	500	RWU50-9	500
RWU60-9	600	RWU60-9	600	RWU60-9	600	RWU60-9	600

OPEN WALL		MIDI UNITS		LARDER	
H:290mm CODE	WIDTH	H:120mm CODE	WIDTH	H:1970mm CODE	WIDTH
RWOS50-2	500	RMLU60	600	RTLU30	300
RWOS60-2	600	RMA160	600	RTLU40	400
RWOS80-2	800	RMD060	600	RTLU50	500
RWOS90-2	900	RMOH560	600	RTLU60	600
RWOS10-2	1000			TLU80	800
				TLU10	1000

LARDER		DRAWER LARDER		DIAGONAL WALK-IN LARDER		DIAGONAL		PULL-OUT LARDER		INNER DRAWER LARDER	
H:2150mm CODE	WIDTH	H:1970mm CODE	WIDTH	H:1970mm CODE	WIDTH	H:1970mm CODE	WIDTH	H:1970mm CODE	WIDTH	H:1970mm CODE	WIDTH
RETLU30	300	TDLU80	800	TDWIL1144	1144x1144	TDCLU1003	1003x1003	RTIPOL30	300	RTLID30	300
RETLU40	400	TDLU10	1000	ETDWIL1144*	1144x1144	ETDCLU1003*	1003x1003	RTKPOL30	300	RTLID40	400
RETLU50	500							Standard Mechanism inc.		RTLID50	500
RETLU60	600							RETISPOL30*	300	RTLID60	600
RETLU80	800							RETSPOL30*	300		
ETLU10	1000							Kesseböhmer Mechanism inc.			

DOUBLE OVEN		SINGLE OVEN		SINGLE OVEN + COMPACT		COMPACT		TALL FRIDGE/FREEZER		BOX WINE RACKS	
H:1970mm CODE	WIDTH	H:1970mm CODE	WIDTH	H:1970mm CODE	WIDTH	H:1970mm CODE	WIDTH	H:1970mm CODE	WIDTH	H:1970mm CODE	WIDTH
RTOHD60	600	RTOHS60	600	RTOHS60	600	RTOHC60	600	RTFF1/60	600	RETF1/60	600
RTOHD60*	600	RETOHS60*	600	RETOHS60*	600	RETOHC60*	600	RTFF4/60*	600	RETF4/60*	600
								RTFF1U/60#	600	RETF1U/60#	600
								RTFF4U/60#	600	RETF4U/60#	600

END SUPPORT PANELS		CARCASE MFC PANELS		CORNICE / PELMET		PLINTH	
H:900mm CODE	WIDTH	CODE	WXH	H:25mm CODE	LENGTH	H:25mm CODE	WIDTH
ESP	600	1970/300	300x1970	PCMB	3000	CCMS/BM	322x322
900/700	700	2150/560	560x2150	UG/*ET	1000x22	PL	2940
		2350/660	660x2350	*Un-Glued 1m carcass edging		MFC Carcase	
		720/300	300x720			PL/BM	3000
		900/2000	2000x900				
		900/300	300x900				

PLANT ON END PANELS		FURNITURE ACCESSORIES		INTEGRATED DOORS		SPARE DOOR FITTINGS		GENERAL ACCS.	
CODE	WXH	CODE	WXH	CODE	WXH	CODE	DESCRIPTION	CODE	DESCRIPTION
2440/350/22BM	350x2440	900/2400/22BM	2400x900	INTG045	596x450	SCHINGE90	Hinges [Hettich Soft Close]	STPWN	Set of 2 Door Strapping Plates
2440/650/22BM	650x2440			INTG571	446x715	SCHINGE170	Stays [Blum Aventos]	LEGSET	Set of 4 Adjustable legs
900/650/22BM	650x900			INTG6014	596x140			SACC	Pk 50 14mm Self Adhesive Cover Caps
910/1185/22BM	1185x910			INTG6057	596x570				
950/350/22BM	350x950			INTG6071	596x715				

Note: Furniture codes beginning with the letter 'R' are assembled (rigid), by removing the 'R' the units are supplied unassembled (flat-pack).



## Slab

Transform your space with our Slab kitchen collection - a modern embodiment of simplicity and style. The sleek, plain slab doors seamlessly integrate into a contemporary setting, offering an understated charm.

Choose between the high-gloss finish for a sophisticated sheen or the painted matt kitchen for a laid-back feel.

SLAB  
PRICE GROUP 2  
**BRAVA**

Special sizes available  
contact us for further information

Colours Options [PG2]: Concrete, Dark Oak and Rustic Iron



HI-LINE BASE LOW BASE

HI-LINE BASE				LOW BASE			
H:720mm CODE	WIDTH	CODE	WIDTH	H:720mm CODE	WIDTH	CODE	WIDTH
RBA15	150	R2BA60*	600	RBISPO15	150	RABA360	360
RBA30	300	RBA70#	700	RSBU30	300	RSBU70#	700
RBA35	350	RBA90#	900	RSBU35	350	RSBU80#	800
RBA40	400	RBA90#	900	RSBU40	400	RSBU90#	900
RBA45	450	RBA10#	1000	RSBU45	450	RSBU10#	1000
RBA50	500	RBA12#	1200	RSBU50	500	RSBU50	500
RBA60	600	*No muntin [2x300 doors] # 2 x Doors		RSBU60	600	RLBU30	300
						RLBU40	400
						RLBU45	450
						RLBU50	500
						RLBU60	600

HI-LINE CORNER BASE DRAWERLINE BASE DRAWERLINE SINK BASE

HI-LINE CORNER BASE				DRAWERLINE BASE				DRAWERLINE SINK BASE			
H:720mm CODE	WIDTH	CODE	WIDTH	H:720mm CODE	WIDTH	CODE	WIDTH	H:720mm CODE	WIDTH	CODE	WIDTH
RBAC830	800/300	RBAC950	900/500	RBD30	300	RBD80#	800	RBBD0/1	800	RBD50	500
RBAC80	800/400	RBAC960	900/600	RBD40	400	RBD90#	900	RBBD90/1	900	RBD60	600
RBAC845	800/450	RBAC140	1000/400	RBD45	450	RBD10#	1000	RBBD10/1	1000		
RBAC850	800/500	RBAC145	1000/450	RBD50	500	RBD12#	1200				
RBAC860	800/600	RBAC10	1000/500	RBD60	600						
RBAC940	900/400	RBAC160	1000/600								
RBAC945	900/450	RBAC12	1200/600								

CERAMIC SINK BASE DRAWERLINE CORNER BASE BUILT UNDER 2 DRAWER BASE 3 DRAWER BASE 4 DRAWER BASE

CERAMIC SINK BASE				DRAWERLINE CORNER BASE				BUILT UNDER		2 DRAWER BASE		3 DRAWER BASE		4 DRAWER BASE	
H:460mm CODE	WIDTH	CODE	WIDTH	H:720mm CODE	WIDTH	CODE	WIDTH	Oven	Microwave	H:720mm CODE	WIDTH	H:720mm CODE	WIDTH	H:720mm CODE	WIDTH
RBSU60	600	RBDC830	800/300	RBDC140	1000/400	RBU060	600			RBD250	500	RBD350	500	RBD450	500
		RBDC80	800/400	RBDC145	1000/450					RBD260	600	RBD360	600	RBD460	600
		RBDC845	800/450	RBDC10	1000/500					RBD280	800	RBD380	800	RBD480	800
		RBDC850	800/500	RBDC160	1000/600					RBD290	900	RBD390	900	RBD490	900
		RBDC860	800/600	RBDC12	1200/600					RBD210	1000	RBD310	1000	RBD410	1000

5 DRAWER BASE LOW WALL MEDIUM WALL

5 DRAWER BASE				LOW WALL				MEDIUM WALL			
H:720mm CODE	WIDTH	CODE	WIDTH	H:575mm CODE	WIDTH	CODE	WIDTH	H:720mm CODE	WIDTH	CODE	WIDTH
RBD530	300	RWU30-5	300	RCWD60-5	600x600	RAWU360-5	360	RWU30-7	300	R2WU60-9*	600
RBD540	400	RWU40-5	400	Add 'X' to the end of the code for 350mm deep [650x650]		Add 'X' to the end of the code for 350mm deep		RWU35-7	350	RWU70-7#	700
RBD545	450	RWU45-5	450					RWU40-7	400	RWU80-7#	800
RBD550	500	RWU50-5	500					RWU45-7	450	RWU90-7#	900
RBD560	600	RWU60-5	600					RWU50-7	500	RWU10-7#	1000

MEDIUM WALL TALL WALL

MEDIUM WALL				TALL WALL			
H:720mm CODE	WIDTH	CODE	WIDTH	H:900mm CODE	WIDTH	CODE	WIDTH
RCWL60-7	600x600	RWUC260-7	600	RWU30-9	300	R2WU60-9*	600
				RWU40-9	400	RWU80-9#	800
				RWU45-9	450	RWU90-9#	900
				RWU50-9	500	RWU10-9#	1000
				RWU60-9	600		

TALL WALL HORIZONTAL WALL OPEN WALL

TALL WALL				HORIZONTAL WALL				OPEN WALL			
H:900mm CODE	WIDTH	CODE	WIDTH	H:290mm CODE	WIDTH	H:360mm CODE	WIDTH	H:290mm CODE	WIDTH	H:360mm CODE	WIDTH
RCWL60-9	600x600	RAWU360-9	360	RHWU5029	500	RHWU5036	500	RWOS50-2	500	RWOS50-3	500
				RHWU6029	600	RHWU6036	600	RWOS60-2	600	RWOS60-3	600
				RHWU8029	800	RHWU8036	800	RWOS80-2	800	RWOS80-3	800
				RHWU9029	900	RHWU9036	900	RWOS90-2	900	RWOS90-3	900
				RHWU1029	1000	RHWU1036	1000	RWOS10-2	1000	RWOS10-3	1000

OPEN WALL MIDI UNITS LARDER

OPEN WALL				MIDI UNITS				LARDER			
H:720mm CODE	WIDTH	CODE	WIDTH	H:900mm CODE	WIDTH	H:1210mm CODE	WIDTH	H:1250mm CODE	WIDTH	H:1970mm CODE	WIDTH
RWOS30-7	300	RWOS30-9	300	RMLU60	600	RDC1/50	500	RMLU60	600	RTL30	300
RWOS40-7	400	RWOS40-9	400	RMA160	600	RDC1/60	600	RMA160	600	RTL40	400
RWOS45-7	450	RWOS45-9	450					RMD060	600	RTL50	500
RWOS50-7	500	RWOS50-9	500					RMOH560	600	RTL60	600
RWOS60-7	600	RWOS60-9	600							TLU80	800

LARDER PULL-OUT LARDER INNER DRAWER LARDER

LARDER				PULL-OUT LARDER				INNER DRAWER LARDER			
H:1970mm CODE	WIDTH	CODE	WIDTH	H:1970mm CODE	WIDTH	H:1970mm CODE	WIDTH	H:1970mm CODE	WIDTH	H:1970mm CODE	WIDTH
RTLUD50	500	TDLU80	800	TCLU98	985x985	TDWIL1144	1144x1144	TDCLU1003	1003x1003	RTISPOL30	300
RTLUD60	600	TDLU10	1000	ETCLU98*	985x985	ETDWIL1144*	1144x1144	ETDCLU1003*	1003x1003	RTKPOL30	300

INNER DRAWER LARDER DOUBLE OVEN SINGLE OVEN SINGLE OVEN + COMPACT COMPACT TALL FRIDGE/FREEZER

INNER DRAWER LARDER				DOUBLE OVEN				SINGLE OVEN				SINGLE OVEN + COMPACT				COMPACT				TALL FRIDGE/FREEZER			
H:2150mm CODE	WIDTH	CODE	WIDTH	H:1970mm CODE	WIDTH	H:1970mm CODE	WIDTH	H:1970mm CODE	WIDTH	H:1970mm CODE	WIDTH	H:1970mm CODE	WIDTH	H:1970mm CODE	WIDTH	H:1970mm CODE	WIDTH	H:1970mm CODE	WIDTH				
RETLID30	300	OTOHDD60	600	RTOHS60	600	RTOHSC60	600	RTOHC60	600	RTFF1/60	600	RTFF2/60	600	RTFF4/60*	600	RTFF1U/60#	600	RTFF2U/60#	600				
RETLID40	400	RETOHDD60*	600	RETOHS60*	600	RETOHSC60*	600	RETOHC60*	600	*Doors undrilled													

BOX WINE RACKS END SUPPORT PANELS CARCASE MFC PANELS CORNICE / PELMET PLINTH

BOX WINE RACKS				END SUPPORT PANELS				CARCASE MFC PANELS				CORNICE / PELMET				PLINTH			
W:125mm / W:250mm*	HEIGHT	CODE	HEIGHT	H:900mm CODE	WIDTH	CODE	WIDTH	WXH	CODE	WXH	H:22mm CODE	LENGTH	H:150mm CODE	WIDTH	CODE	WIDTH			
	720	RWR125-7	1210	ESP	600	1970/300	300x1970	UG/**ET	1000x22	PCM/B	3000	PL	2940	PST	3000				
	720	RWR250-7*	1970	900/700	700	2150/560	560x2150	*Un-glued 1m carcass edging											

PLANT ON END PANELS FURNITURE ACCESSORIES INTEGRATED DOORS SPARE DOOR FITTINGS GENERAL ACCS.

PLANT ON END PANELS				FURNITURE ACCESSORIES				INTEGRATED DOORS				SPARE DOOR FITTINGS				GENERAL ACCS.			
22mm	22mm Breakfast Bar Panel	Corner Post [Spare]	Undrilled	H:715mm CODE	WIDTH	CODE	WXH	CODE	WXH	Hinges [Hettich Soft Close]	Stays [Blum Aventos]	CODE	STPWN	Set of 2	LEGSET	Set of 4			
2400/350/22B	350x2440	900/2400/22B	2400x900	CP/B	146	INT4571	446x715	SCHINGE90	90 degree [Pair]	BLSTAYHKS	HK-5 stay [Pair]	SACC	Pk 50						

Note: Furniture codes beginning with the letter 'R' are assembled (rigid), by removing the 'R' the units are supplied unassembled (flat-pack).

Note: Furniture codes beginning with the letter 'R' are assembled (rigid), by removing the 'R' the units are supplied unassembled (flat-pack).

SLAB  
PRICE GROUP 2  
**COMO**  
Special sizes available  
contact us for further information  
Colours Options [PG2]: Cashmere, Dust Grey, Fern, Grey, Indigo, Oyster, Sage and White.



**HI-LINE BASE** **LOW BASE**

**Pull-Out** **Splayed** **Shallow Base [300mm deep]**

H:720mm CODE	WIDTH	CODE	WIDTH	H:720mm CODE	WIDTH	H:720mm CODE	WIDTH	H:720mm CODE	WIDTH	H:575mm CODE	WIDTH	CODE	WIDTH
RBA15	150	R2BA60*	600	RBISPO15	150	RBA360	360	RSBU30	300	RSBU70*	700	RLBU30	300
RBA25	250	RBA70*	700	Standard Mechanism inc.				RSBU35	350	RSBU80*	800	RLBU40	400
RBA30	300	RBA80*	800	RBKPO15	150			RSBU40	400	RSBU90*	900	RLBU45	450
RBA35	350	RBA90*	900	Kesseböhmer Mechanism inc.				RSBU45	450	RSBU10*	1000	RLBU50	500
RBA40	400	RBA10*	1000	RBKTP015	150			RSBU50	500	RSBU10*	1000	RLBU60	600
RBA45	450	RBA12*	1200	Kesseböhmer Mechanism & Towel rail inc.				RSBU60	600	# 2 x Doors			
RBA50	500	*No muntin [2x300 doors]											
RBA60	600	# 2 x Doors											

**HI-LINE CORNER BASE** **DRAWERLINE BASE** **DRAWERLINE SINK BASE** **CERAMIC SINK BASE**

**'L' Shaped** **Diagonal** **Single Top Drawer**

H:720mm CODE	WIDTH	CODE	WIDTH	H:720mm CODE	WIDTH	H:720mm CODE	WIDTH	H:720mm CODE	WIDTH	H:720mm CODE	WIDTH	H:460mm CODE	WIDTH
RBAC830	800/300	RBAC950	900/500	BAC90	900x900	CDA90	900x900	RBD30	300	RBD80/1	800	RBD50	500
RBAC840	800/400	RBAC960	900/600	Bi-fold hinge system				RBD40	400	RBD90/1	900	RBD60	600
RBAC845	800/450	RBAC140	1000/400	Flatpack				RBD45	450	RBD10/1	1000	RBD80*	800
RBAC850	800/500	RBAC145	1000/450					RBD50	500	RBD10*	1000	RBD90*	900
RBAC860	800/600	RBAC10	1000/500					RBD60	600	RBD12*	1200	RBD20*	2000
RBAC940	900/400	RBAC160	1000/600					RBD80*	800			RBD10*	1000
RBAC945	900/450	RBAC12	1200/600					RBD90*	900			RBD12*	1200

Inc. Corner Post & Blanking Panel

**DRAWERLINE CORNER BASE** **BUILT UNDER** **2 DRAWER BASE** **3 DRAWER BASE** **4 DRAWER BASE** **5 DRAWER BASE**

**Oven** **Microwave**

H:720mm CODE	WIDTH	CODE	WIDTH	H:720mm CODE	WIDTH	H:720mm CODE	WIDTH	H:720mm CODE	WIDTH	H:720mm CODE	WIDTH	H:720mm CODE	WIDTH
RBDC830	800/300	RBDC140	1000/400	RBU060	600	RBUM60	600	RBD250	500	RBD350	500	RBD450	500
RBDC840	800/400	RBDC145	1000/450	175mm drawer & 110mm filler				RBD260	600	RBD360	600	RBD460	600
RBDC845	800/450	RBDC10	1000/500					RBD280	800	RBD380	800	RBD480	800
RBDC850	800/500	RBDC160	1000/600					RBD290	900	RBD390	900	RBD490	900
RBDC860	800/600	RBDC12	1200/600					RBD210	1000	RBD310	1000	RBD410	1000

Inc. Corner Post & Blanking Panel

**LOW WALL** **MEDIUM WALL**

**Diagonal Corner** **Splayed** **Glazed Door** **Diagonal Corner**

H:575mm CODE	WIDTH	CODE	WIDTH	H:575mm CODE	WIDTH	H:720mm CODE	WIDTH	H:720mm CODE	WIDTH	H:720mm CODE	WIDTH
RWU30-5	300	R2WU60-5*	600	RCWD60-5	600x600	RAWU360-5	360	RWU25-7	250	R2WU60-7*	600
RWU40-5	400	RWU80-5*	800	Add 'X' to the end of the code for 350mm deep [650x650]				RWU30-7	300	RWU70-7*	700
RWU45-5	450	RWU90-5*	900					RWU35-7	350	RWU80-7*	800
RWU50-5	500	RWU10-5*	1000					RWU40-7	400	RWU90-7*	900
RWU60-5	600	*No muntin # 2 x Doors						RWU45-7	450	RWU10-7*	1000

Add 'X' to the end of the code for 350mm deep

**MEDIUM WALL** **TALL WALL**

**'L' Shaped Corner** **Conventional Corner** **Splayed** **Microwave Wall** **Bi-Fold** **Glazed Door**

H:720mm CODE	WIDTH	CODE	WIDTH	H:720mm CODE	WIDTH	H:900mm CODE	WIDTH	H:900mm CODE	WIDTH
RCWL60-7	600x600	RWUC60-7	600	RAWU360-7	360	RMWU60-7	600	RBFWU50-7	500
Inc. Corner Post		Add 'X' to the end of the code for 350mm deep		Add 'X' to the end of the code for 350mm deep				RBFWU60-7	600
								RBFWU80-7	800
								RBFWU90-7	900
								RBFWU10-7	1000

**TALL WALL** **HORIZONTAL WALL** **GLAZED DRESSER** **OPEN WALL**

**Diagonal Corner** **Splayed** **Boiler Wall**

H:900mm CODE	WIDTH	H:900mm CODE	WIDTH	H:900mm CODE	WIDTH	H:290mm CODE	WIDTH	H:360mm CODE	WIDTH	H:1210mm CODE	WIDTH	H:290mm CODE	WIDTH	H:360mm CODE	WIDTH
RCWD60-9	600x600	RAWU360-9	360	BWU6040-9	600	RHWU5029	500	RHWU5036	500	RDR1/50	500	RWOS50-2	500	RWOS50-3	500
Add 'X' to the end of the code for 350mm deep [650x650]		Add 'X' to the end of the code for 350mm deep		400mm Deep Flatpack		RHWU6029	600	RHWU6036	600	Dresser Unit - 1 door		RWOS60-2	600	RWOS60-3	600
						RHWU8029	800	RHWU8036	800	Add 'X' to the end of the code for 350mm deep		RWOS80-2	800	RWOS80-3	800
						RHWU9029	900	RHWU9036	900			RWOS90-2	900	RWOS90-3	900
						RHWU1029	1000	RHWU1036	1000			RWOS10-2	1000	RWOS10-3	1000

Add 'X' to the end of the code for 350mm deep

If 350mm deep carcass is required adjust code, e.g. RWOS1035-2

If 350mm deep carcass is required adjust code, e.g. RWOS1035-3

**OPEN WALL** **MIDI UNITS** **LARDER**

**RMLU60** **RMA160** **RMD060** **RMOHS60** **RTLU30** **RTLU40** **RTLU50** **RTLU60** **TLU80** **TLU10**

H:575mm CODE	WIDTH	H:720mm CODE	WIDTH	H:900mm CODE	WIDTH	H:1210mm CODE	WIDTH	H:1970mm CODE	WIDTH	H:2150mm CODE	WIDTH
RWOS30-5	300	RWOS30-7	300	RWOS30-9	300	RDC1/50	500	RMLU60	600	RTLU30	300
RWOS40-5	400	RWOS40-7	400	RWOS40-9	400	RDC1/60	600	RMA160	600	RTLU40	400
RWOS45-5	450	RWOS45-7	450	RWOS45-9	450	MFC Carcass		RMD060	600	RTLU50	500
RWOS50-5	500	RWOS50-7	500	RWOS50-9	500	If 350mm deep carcass is required adjust code, e.g. RDC1/350		RMOHS60	600	RTLU60	600
RWOS60-5	600	RWOS60-7	600	RWOS60-9	600					TLU80	800
RWOS80-5	800	RWOS80-7	800	RWOS80-9	800					TLU10	1000
RWOS90-5	900	RWOS90-7	900	RWOS90-9	900						
RWOS10-5	1000	RWOS10-7	1000	RWOS10-9	1000						

If 350mm deep carcass is required adjust code, e.g. RWOS1035-5

If 350mm deep carcass is required adjust code, e.g. RWOS1035-7

If 350mm deep carcass is required adjust code, e.g. RWOS1035-9

**LARDER** **PULL-OUT LARDER** **INNER DRAWER LARDER**

**Drawer Larder** **'L' Shaped** **Diagonal Walk-in Larder** **Diagonal**

H:1970mm CODE	WIDTH	H:1970mm CODE	*H:2150mm WIDTH	H:1970mm CODE	*H:2150mm WIDTH	H:1970mm CODE	*H:2150mm WIDTH	H:1970mm CODE	*H:2150mm WIDTH	H:1970mm CODE	WIDTH	H:2150mm CODE	WIDTH
TDLU80	800	TDLU98	985x985	TDWIL1144	1144x1144	TDCLU1003	1003x1003	RTISPOL30	300	RTLID30	300	RETLID30	300
TDLU10	1000	ETDLU98*	985x985	ETDWIL1144*	1144x1144	ETDCLU1003*	1003x1003	RTKPOL30	300	RTLID40	400	RETLID40	400
2x355mm Drawers		Bi-fold hinge system						RETISPOL30*	300	RTLID50	500	RETLID50	500
								RETIPOL30*	300	RTLID60	600	RETLID60	600

Standard Mechanism inc.  
Kesseböhmer Mechanism inc.

1 x Standard, 4 x Deep drawers

**DOUBLE OVEN** **SINGLE OVEN** **SINGLE OVEN + COMPACT** **COMPACT** **TALL FRIDGE/FREEZER** **BOX WINE RACKS**

H:1970mm CODE	*H:2150mm WIDTH	H:1970mm CODE	*H:2150mm WIDTH	H:1970mm CODE	*H:2150mm WIDTH	H:1970mm CODE	WIDTH	H:1970mm CODE	WIDTH	H:2150mm CODE	WIDTH	W:125mm / W:250mm*	HEIGHT
RTOHD60	600	RTOHS60	600	RETOHSC60	600	RETOHC60	600	RTFF1/60	600	RTFF1/60	600	RWR125-7	720
RTOHD60*	600	RETOHS60*	600	RETOHSC60*	600	RETOHC60*	600	RTFF3/60*	600	RTFF2/60	600	RWR250-7*	720
								*Doors supplied undrilled		RTFF1U/60*	600	RWR125-9	900
								RTFFU/60*	600	RTFF2U/60*	600	RWR250-9*	900
								RTFF3U/60*	600	# For door on door appliances		RWR125-1210	1210

\*For door on door appliances

MFC Carcass  
If using as base order LEGSET

**END SUPPORT PANELS** **CARCASS MFC PANELS** **CORNICE - MODERN** **PLINTH** **PLANT ON END PANELS**

**Modern** **Clear Sealing Strip** **18mm Plain** **18mm Tongue & Grooved**

H:900mm CODE	WIDTH	CODE	WXH	H:31mm CODE	WIDTH	H:150mm CODE	WIDTH	CODE	WIDTH	CODE	WXH	CODE	WXH
ESP	600	1970/300	300x1970	CM/OF	3000	PL	2940	PST	3000	1387/350P/OF	350x1387	1387/350T/18OF	350x1387
900/700	700	2150/560	560x2150	Door Finish		MFC Carcass				2400/650P/OF	650x2400	2400/650T/18OF	650x2400
MFC Carcass		2350/660	660x2350			PL/OF	2400			900/650P/OF	650x900	900/650T/18OF	650x900
		720/300	300x720			Door Finish				964/350P/OF	350x964	964/350T/18OF	350x964
		900/2000	2000x900										
		900/300	300x900										

MFC Carcass  
UG\*\*ET  
\*Un-Glued 1m Carcass Edging

**PLANT ON END PANELS** **FURNITURE ACCESSORIES** **INTEGRATED DOORS** **SPARE DOOR FITTINGS** **GENERAL ACCS.**

**18mm Plain Breakfast Bar Panel** **18mm Tongue & Grooved Breakfast Bar Panel** **Corner Post [Spare]** **Door Hung Spice Rack** **Undrilled** **Hinges [Hettich Soft Close]** **STPWN** **LEGSET** **SACC**

CODE	WXH	CODE	WXH	CODE	WIDTH	CODE	WXD	CODE	WXH	CODE	Set of
915/2400P/OF	2400x915	915/2400T/OF	2400x915	CPOF*1	146	DHSR/BNO	350x106	INT4571	446x715	BLSTAYHKS	Set of 2
Door Finish		Door Finish		Flat Panel for on site conversion				INT6071	596x715	HK-5 stay [Pair]	Set of 4
				Door Finish						*[inc mounting brackets]	

SLAB  
PRICE GROUP 2  
**DARGA**

Colours Options [PG2]: Cashmere, Cloud, Dust Grey, Graphite, Light Grey and White.



HI-LINE BASE LOW BASE HI-LINE CORNER BASE

Pull-Out		Splayed		Curved Door		Curved Return [300mm deep]	
H:720mm CODE	WIDTH	H:720mm CODE	WIDTH	H:720mm CODE	WIDTH	H:720mm CODE	WIDTH
RBA15	150	RBA30	300	RCDRBA30	300x300	RCRBA26	260
RBA26	260	RBA45	450				
RBA30	300	RBA60	600				
RBA35	350						
RBA40	400						
RBA45	450						
RBA50	500						
RBA60	600						

HI-LINE CORNER BASE DRAWERLINE BASE DRAWERLINE SINK BASE CERAMIC SINK BASE DRAWERLINE CORNER BUILT UNDER 2 DRAWER BASE

'L' Shaped		Single Top Drawer		Diagonal		Oven		Microwave	
H:720mm CODE	WIDTH	H:720mm CODE	WIDTH	H:720mm CODE	WIDTH	H:720mm CODE	WIDTH	H:720mm CODE	WIDTH
BAC90	900x900	RBD30	300	RBD50	500	RBU060	600	RBD250	500
		RBD40	400	RBD60	600			RBD260	600
		RBD45	450	RBD80	800			RBD280	800
		RBD50	500	RBD90	900			RBD290	900
		RBD60	600	RBD10	1000			RBD210	1000
		RBD80	800	RBD12	1200				
		RBD90	900						
		RBD10	1000						
		RBD12	1200						

3 DRAWER BASE 4 DRAWER BASE 5 DRAWER BASE LOW WALL MEDIUM WALL

3 DRAWER BASE		4 DRAWER BASE		5 DRAWER BASE		Diagonal Corner		Splayed	
H:720mm CODE	WIDTH	H:720mm CODE	WIDTH	H:720mm CODE	WIDTH	H:720mm CODE	WIDTH	H:720mm CODE	WIDTH
RBD350	500	RBD450	500	RBD530	300	RWU30-5	300	RCWD60-5	600x600
RBD360	600	RBD460	600	RBD540	400	RWU40-5	400		
RBD380	800	RBD480	800	RBD545	450	RWU45-5	450		
RBD390	900	RBD490	900	RBD550	500	RWU50-5	500		
RBD310	1000	RBD410	1000	RBD560	600	RWU60-5	600		
				RBD580	800	RZWU60-5*	600		
				RBD590	900	RWU70-5	700		
				RBD510	1000	RWU80-5	800		
						RWU90-5	900		
						RWU10-5	1000		

MEDIUM WALL

Glazed Door		Diagonal Corner		'L' Shaped Corner		Conventional Corner		Splayed		Curved Door		Microwave Wall	
H:720mm CODE	D:300mm WIDTH	H:720mm CODE	D:300mm WIDTH	H:720mm CODE	D:300mm WIDTH	H:720mm CODE	D:300mm WIDTH	H:720mm CODE	D:300mm WIDTH	H:720mm CODE	D:300mm WIDTH	H:720mm CODE	D:300mm WIDTH
RWG50-7*	500	RCWD60-7	600x600	RCWL60-7	600x600	RWUC60-7	600	RAWU360-7	360	RCDWU30-7	300x300	RMWU60-7	600
RWG10-7*	1000												

Note: Furniture codes beginning with the letter 'R' are assembled (rigid), by removing the 'R' the units are supplied unassembled (flat-pack).

MEDIUM WALL		TALL WALL		Glazed Door		Diagonal Corner		Splayed		Boiler Wall	
H:720mm CODE	D:300mm WIDTH	H:900mm CODE	WIDTH	H:900mm CODE	WIDTH	H:900mm CODE	D:300mm WIDTH	H:900mm CODE	D:300mm WIDTH	H:900mm CODE	WIDTH
RBFWU50-7	500	RWU30-9	300	RZWU60-9*	600	RWG50-9*	500	RCWD60-9	600x600	RAWU360-9	360
RBFWU60-7	600	RWU40-9	400	RWU80-9*	800	RWG10-9*	1000			RAWU6040-9	600
RBFWU80-7	800	RWU45-9	450	RWU90-9*	900						
RBFWU90-7	900	RWU50-9	500	RWU10-9*	1000						
RBFWU10-7	1000	RWU60-9	600								

HORIZONTAL WALL		OPEN WALL		OPEN WALL	
H:290mm CODE	D:300mm WIDTH	H:290mm CODE	WIDTH	H:290mm CODE	WIDTH
RHWU5029	500	RWOS50-2	500	RWOS50-3	500
RHWU6029	600	RWOS60-2	600	RWOS60-3	600
RHWU8029	800	RWOS80-2	800	RWOS80-3	800
RHWU9029	900	RWOS90-2	900	RWOS90-3	900
RHWU1029	1000	RWOS10-2	1000	RWOS10-3	1000

MIDI UNITS LARDER

RMLU60		RMA160		Drawer Larder		'L' Shaped		Diagonal		Diagonal Walk-in Larder	
H:1970mm CODE	WIDTH	H:1970mm CODE	WIDTH	H:1970mm CODE	WIDTH	H:1970mm CODE	*H:2150mm WIDTH	H:1970mm CODE	*H:2150mm WIDTH	H:1970mm CODE	*H:2150mm WIDTH
RMLU30	300	RMA160	160	TDLU80	800	TCLU98	985x985	TDCLU1003	1003x1003	TDWIL1144	1144x1144
RMLU40	400			TDLU10	1000	ETCLU98*	985x985	ETDCLU1003*	1003x1003	ETDWIL1144*	1144x1144

INNER DRAWER LARDER DOUBLE OVEN SINGLE OVEN SINGLE OVEN + COMPACT COMPACT TALL FRIDGE/FREEZER TALL FRIDGE/FREEZER

INNER DRAWER LARDER		DOUBLE OVEN		SINGLE OVEN		SINGLE OVEN + COMPACT		COMPACT		TALL FRIDGE/FREEZER		TALL FRIDGE/FREEZER	
H:1970mm CODE	WIDTH	H:2150mm CODE	WIDTH	H:1970mm CODE	WIDTH	H:1970mm CODE	*H:2150mm WIDTH	H:1970mm CODE	*H:2150mm WIDTH	H:1970mm CODE	WIDTH	H:2150mm CODE	WIDTH
RTLID30	300	RETLD30	300	RTOHD60	600	RTOHS60	600	RTOHSC60	600	RTFF1/60	600	RETFF1/60	600
RTLID40	400	RETLD40	400	RTOHDD60	600	RTOHSD60	600	RETOHSC60*	600	RTFF4/60*	600	RETFF2/60	600

BOX WINE RACKS END SUPPORT PANELS CARCASE MFC PANELS CORNICE + PELMET PLINTH

BOX WINE RACKS		END SUPPORT PANELS		CARCASE MFC PANELS		CORNICE + PELMET		PLINTH	
W:125mm / W:250mm*	HEIGHT	H:900mm CODE	WIDTH	CODE	WXH	H:28mm CODE	LENGTH	H:28mm CODE	WIDTH
RWR125-7	720	ESP	600	1970/300	300x1970	CM/UG	3000	PL	2940
RWR250-7*	720	900/700	700	2150/560	560x2150	CM/UG	3000	PST	3000

PLINTH PLANT ON END PANELS FURNITURE ACCESSORIES INTEGRATED DOORS SPARE DOOR FITTINGS GENERAL ACCS.

PLINTH		PLANT ON END PANELS		FURNITURE ACCESSORIES		INTEGRATED DOORS		SPARE DOOR FITTINGS		GENERAL ACCS.	
H:150mm CODE	WXD	CODE	WXH	CODE	WXH	CODE	WXH	CODE	CODE	CODE	DESCRIPTION
CPLS/UG	430x320	900/1200/18UG	650x2430	CP/UG	146	INT4571	446x715	SCHINGE90	BLSTAYHKS	STPNW	Set of 2 Door Strapping Plates

Note: Furniture codes beginning with the letter 'R' are assembled (rigid), by removing the 'R' the units are supplied unassembled (flat-pack).

SLAB  
PRICE GROUP 3  
**ENKO**  
Special sizes available  
contact us for further information  
Colours Options [PG3]: Black, Fern, Hunter, Indigo, Stone and Taupe.



**HI-LINE BASE** **Pull-Out** **Splayed** **Shallow Base [300mm deep]** **LOW BASE**

CODE	WIDTH	CODE	WIDTH	CODE	WIDTH	CODE	WIDTH	CODE	WIDTH	CODE	WIDTH	CODE	WIDTH	CODE	WIDTH
RBA15	150	RBA60*	600	RBISPO15	150	RBA360	360	RSBU30	300	RSBU70*	700	RLBU30	300	RLBU80*	800
RBA26	260	RBA70*	700	RBKPO15	150			RSBU35	350	RSBU80*	800	RLBU40	400	RLBU90*	900
RBA30	300	RBA80*	800					RSBU40	400	RSBU90*	900	RLBU45	450	RLBU10*	1000
RBA35	350	RBA90*	900					RSBU45	450	RSBU10*	1000	RLBU50	500	RLBU12*	1200
RBA40	400	RBA10*	1000					RSBU50	500			RLBU60	600		
RBA45	450	RBA12	1200					RSBU60	600						
RBA50	500														

**HI-LINE CORNER BASE** **DRAWERLINE BASE** **DRAWERLINE SINK BASE** **CERAMIC SINK BASE** **DRAWERLINE CORNER**

CODE	WIDTH	CODE	WIDTH	CODE	WIDTH	CODE	WIDTH	CODE	WIDTH	CODE	WIDTH	CODE	WIDTH	CODE	WIDTH
RBAC830	800/300	RBAC950	900/500	BAC90	900x900	RBD30	300	RBD80/1	800	RBD50	500	RBD60	600	RBD80*	800
RBAC80	800/400	RBAC960	900/600			RBD40	400	RBD90/1	900	RBD60*	600	RBD80*	800	RBD90*	900
RBAC845	800/450	RBAC140	1000/400			RBD45	450	RBD10/1	1000	RBD80*	800	RBD90*	900	RBD10*	1000
RBAC850	800/500	RBAC145	1000/450			RBD50	500			RBD90*	900	RBD10*	1000	RBD12*	1200
RBAC860	800/600	RBAC10	1000/500			RBD60	600			RBD10*	1000	RBD12*	1200		
RBAC940	900/400	RBAC160	1000/600			RBD80*	800			RBD12*	1200				
RBAC945	900/450	RBAC12	1200/600			RBD90*	900			RBD12*	1200				

**BUILT UNDER** **2 DRAWER BASE** **3 DRAWER BASE** **4 DRAWER BASE** **5 DRAWER BASE** **LOW WALL**

CODE	WIDTH	CODE	WIDTH	CODE	WIDTH	CODE	WIDTH	CODE	WIDTH	CODE	WIDTH	CODE	WIDTH	CODE	WIDTH
RBUM60	600	RBD250	500	RBD350	500	RBD450	500	RBD530	300	RWD30-5	300	RCWD60-5	600x600	RAWU30-5	300
		RBD260	600	RBD360	600	RBD460	600	RBD540	400	RWU40-5	400			RWU40-5	400
		RBD280	800	RBD380	800	RBD480	800	RBD545	450	RWU45-5	450			RWU45-5	450
		RBD290	900	RBD390	900	RBD490	900	RBD550	500	RWU50-5	500			RWU50-5	500
		RBD210	1000	RBD410	1000	RBD510	1000	RBD560	600	RWU60-5	600			RWU60-5	600

**MEDIUM WALL**

CODE	WIDTH	CODE	WIDTH	CODE	WIDTH	CODE	WIDTH	CODE	WIDTH	CODE	WIDTH	CODE	WIDTH	CODE	WIDTH
RWU26-7	260	RWU70-7*	700	RCWD60-7	600x600	RCWL60-7	600x600	RWUC60-7	600	RAWU360-7	360	RMWU60-7	600	RBFWU50-7	500
RWU30-7	300	RWU80-7*	800											RBFWU60-7	600
RWU35-7	350	RWU90-7*	900											RBFWU80-7	800
RWU40-7	400	RWU10-7*	1000											RBFWU90-7	900
RWU45-7	450													RBFWU10-7	1000

**TALL WALL** **Diagonal Corner** **Splayed** **Boiler Wall** **HORIZONTAL WALL**

CODE	WIDTH	CODE	WIDTH	CODE	WIDTH	CODE	WIDTH	CODE	WIDTH	CODE	WIDTH	CODE	WIDTH	CODE	WIDTH
RWU30-9	300	R2WU60-9*	600	RCWD60-9	600x600	RAWU360-9	360	BWU6040-9	600	RHWU5029	500	RHWU5036	500	RHWU6036	600
RWU40-9	400	RWU80-9*	800							RHWU6029	600	RHWU8036	800	RHWU9036	900
RWU45-9	450	RWU90-9*	900							RHWU8029	800	RHWU1036	1000		
RWU50-9	500	RWU10-9*	1000							RHWU9029	900				
RWU60-9	600									RHWU1029	1000				

**OPEN WALL**

CODE	WIDTH	CODE	WIDTH	CODE	WIDTH	CODE	WIDTH	CODE	WIDTH	CODE	WIDTH	CODE	WIDTH	CODE	WIDTH
RWOS50-2	500	RWOS50-3	500	RWOS30-5	300	RWOS30-7	300	RWOS30-9	300	RDC1/50	500	RMLU60	600	RMA160	600
RWOS60-2	600	RWOS60-3	600	RWOS40-5	400	RWOS40-7	400	RWOS40-9	400	RDC1/60	600	RMD060	600	RMOH560	600
RWOS80-2	800	RWOS80-3	800	RWOS45-5	450	RWOS45-7	450	RWOS45-9	450						
RWOS90-2	900	RWOS90-3	900	RWOS50-5	500	RWOS50-7	500	RWOS50-9	500						
RWOS10-2	1000	RWOS10-3	1000	RWOS60-5	600	RWOS60-7	600	RWOS60-9	600						

**LARDER**

CODE	WIDTH	CODE	WIDTH	CODE	WIDTH	CODE	WIDTH	CODE	WIDTH	CODE	WIDTH	CODE	WIDTH	CODE	WIDTH
RTL30	300	RETL30	300	TLUSD50	500	TDLU80	800	TCLU98	985x985	TDCLU1003	1003x1003	TDWIL1144	1144x1144	ETDCLU1003*	1003x1003
RTLU40	400	RETL40	400	TLUSD60	600	TDLU10	1000	ETCLU98*	985x985						
RTLU50	500	RETL50	500												
RTLU60	600	RETL60	600												
TLU80	800	ETLU80	800												
TLU10	1000	ETLU10	1000												

**PULL-OUT LARDER** **INNER DRAWER LARDER** **DOUBLE OVEN** **SINGLE OVEN** **SINGLE OVEN + COMPACT** **COMPACT**

CODE	WIDTH	CODE	WIDTH	CODE	WIDTH	CODE	WIDTH	CODE	WIDTH	CODE	WIDTH	CODE	WIDTH	CODE	WIDTH
RTSPOL30	300	RTLID30	300	RETLID30	300	OTOHD60	600	OTOHSD60	600	OTOHSC60	600	OTOHC60	600		
RTKPOL30	300	RTLID40	400	RETLID40	400	RETOHDD60*	600	RETOHSD60*	600	RETOHSC60*	600	RETOHC60*	600		
RETSPOL30*	300	RTLID50	500	RETLID50	500										
RETKPOL30*	300	RTLID60	600	RETLID60	600										

**TALL FRIDGE/FREEZER** **BOX WINE RACKS** **END SUPPORT PANELS** **CARCASE MFC PANELS** **COMBI** **PLINTH**

CODE	WIDTH	CODE	WIDTH	CODE	WIDTH	CODE	WIDTH	CODE	WIDTH	CODE	WIDTH	CODE	WIDTH	CODE	WIDTH
RTFF1/60	600	RETFF1/60	600	RWR125-7	720	ESP	600	1970/300	300x1970	H:36mm	UPCM/PM	2740x55	H:150mm	PL	2940
RTFF4/60*	600	RETFF2/60	600	RWR250-7*	720	900/700	700	2150/560	560x2150						
RTFF1U/60*	600	RETFF1U/60*	600	RWR250-9	900			2350/660	660x2350						
RTFF4U/60*	600	RETFF2U/60*	600	RWR250-9*	900			720/300	300x720						

**PLINTH** **PLANT ON END PANELS** **FURNITURE ACCESSORIES** **INTEGRATED DOORS** **SPARE DOOR FITTINGS** **GENERAL ACCS.**

CODE	WIDTH	CODE	WIDTH	CODE	WIDTH	CODE	WIDTH	CODE	WIDTH	CODE	WIDTH	CODE	WIDTH	CODE	WIDTH
PST	3000	2400/650/18PM	650x2400	900/1200/18PM	1200x900	CP/PM	146	INT4571	446x715	Hinges [Hettich Soft Close]		STPWN	Set of 2		
		900/350/18PM	350x900	900/2400/18PM	2400x900			INT6071	596x715	Undrilled		LEGSET	Set of 4		
		900/650/18PM	650x900							Corner Post [Spare]		SCHINGE170	Adjustable legs		
										Un-drilled		SACC	Pk 50		

Note: Furniture codes beginning with the letter 'R' are assembled (rigid), by removing the 'R' the units are supplied unassembled (flat-pack).

Note: Furniture codes beginning with the letter 'R' are assembled (rigid), by removing the 'R' the units are supplied unassembled (flat-pack).

SLAB  
PRICE GROUP 1  
**EPOS**  
Special sizes available  
contact us for further information  
Colours Options [PG]: Slate



HI-LINE BASE

LOW BASE

Pull-Out		Splayed		Shallow Base [300mm deep]			
H:720mm	WIDTH	H:720mm	WIDTH	H:720mm	WIDTH	H:720mm	WIDTH
CODE	WIDTH	CODE	WIDTH	CODE	WIDTH	CODE	WIDTH
RBA15	150	R2BA60*	600	RBISPO15	150	RLBU30	300
RBA26	260	RBA70*	700	Standard Mechanism inc.		RSBU35	350
RBA30	300	RBA80*	800	RBKPO15	150	RSBU40	400
RBA35	350	RBA90*	900	Kesseböhmer Mechanism inc.		RSBU45	450
RBA40	400	RBA10*	1000	RBKTP015	150	RSBU50	500
RBA45	450	RBA12	1200	Kesseböhmer Mechanism & Towel rail inc.		RSBU60	600
RBA50	500	*No muntin [2 x 300 doors] # 2 x Doors					

HI-LINE CORNER BASE | HI-LINE CORNER BASE | DRAWERLINE BASE | DRAWERLINE SINK BASE | CERAMIC SINK BASE | DRAWERLINE CORNER

L' Shaped		Single Top Drawer					
H:720mm	WIDTH	H:720mm	WIDTH	H:720mm	WIDTH	H:720mm	WIDTH
CODE	WIDTH	CODE	WIDTH	CODE	WIDTH	CODE	WIDTH
RBAC830	800/300	RBAC950	900/500	BAC90	900x900	RBDC830	800/300
RBAC80	800/400	RBAC960	900/600	Bi-fold hinge system Flat pack		RBDC80	800/400
RBAC845	800/450	RBAC140	1000/400			RBDC845	800/450
RBAC850	800/500	RBAC145	1000/450			RBDC850	800/500
RBAC860	800/600	RBAC10	1000/500			RBDC860	800/600
RBAC940	900/400	RBAC160	1000/600			RBDC140	1000/400
RBAC945	900/450	RBAC12	1200/600			RBDC145	1000/450

BUILT UNDER | 2 DRAWER BASE | 3 DRAWER BASE | 4 DRAWER BASE | 5 DRAWER BASE | LOW WALL

Oven		Microwave				Diagonal Corner		Splayed	
H:720mm	WIDTH	H:720mm	WIDTH	H:720mm	WIDTH	H:720mm	WIDTH	H:720mm	WIDTH
CODE	WIDTH	CODE	WIDTH	CODE	WIDTH	CODE	WIDTH	CODE	WIDTH
RBUC60	600	RBUC60	600	RBDC350	500	RBDC450	500	RWU30-5	300
		RBDC250	500	RBDC360	600	RBDC460	600	RWU40-5	400
		RBDC260	600	RBDC380	800	RBDC480	800	RWU45-5	450
		RBDC280	800	RBDC390	900	RBDC490	900	RWU50-5	500
		RBDC290	900	RBDC310	1000	RBDC500	600	RWU60-5	600
		RBDC210	1000	1x140mm, 2x283mm Drawers		RBDC580	800	R2WU60-5*	600
				RBDC350/175	500	RBDC590	900	RWU70-5*	700
				RBDC360/175	600	RBDC510	1000	RWU80-5*	800
				2x175mm, 1x355mm Drawers				RWU90-5*	900
								RWU10-5*	1000
								*No muntin [2 x 300 doors] # 2 x Doors	
								Add 'X' to the end of the code for 350mm deep	

MEDIUM WALL

Diagonal Corner		'L' Shaped Corner		Conventional Corner		Splayed		Microwave Wall		Bi-Fold	
H:720mm	WIDTH	H:720mm	WIDTH	H:720mm	WIDTH	H:720mm	WIDTH	H:720mm	WIDTH	H:720mm	WIDTH
CODE	WIDTH	CODE	WIDTH	CODE	WIDTH	CODE	WIDTH	CODE	WIDTH	CODE	WIDTH
RWU26-7	260	R2WU60-7*	600	RCWD60-7	600x600	RCWL60-7	600x600	RWUC60-7	600	RBFWU50-7	500
RWU30-7	300	RWU70-7*	700	Add 'X' to the end of the code for 350mm deep		Bi-fold hinge system		inc. Corner Post		RBFWU60-7	600
RWU35-7	350	RWU80-7*	800			Add 'X' to the end of the code for 350mm deep		Mechanism inc.		RBFWU80-7	800
RWU40-7	400	RWU90-7*	900			Add 'X' to the end of the code for 350mm deep		Add 'X' to the end of the code for 350mm deep		RBFWU90-7	900
RWU45-7	450	RWU10-7*	1000							RBFWU10-7	1000
RWU50-7	500	*No muntin [2x300 doors] # 2 x Doors								Mechanism inc.	
RWU60-7	600									Add 'X' to the end of the code for 350mm deep	

TALL WALL | HORIZONTAL WALL

Diagonal Corner		Splayed		Boiler Wall			
H:900mm	WIDTH	H:900mm	WIDTH	H:900mm	WIDTH	H:290mm	WIDTH
CODE	WIDTH	CODE	WIDTH	CODE	WIDTH	CODE	WIDTH
RWU30-9	300	R2WU60-9*	600	RCWD60-9	600x600	RAWU360-9	360
RWU40-9	400	RWU80-9*	800	Add 'X' to the end of the code for 350mm deep [650x650]		Add 'X' to the end of the code for 350mm deep	
RWU45-9	450	RWU90-9*	900			BWU6040-9	600
RWU50-9	500	RWU10-9*	1000			400mm Deep Flat pack	
RWU60-9	600	*No muntin [2x300 doors] # 2 x Doors					

OPEN WALL | MIDI UNITS

H:290mm		H:360mm		H:575mm		H:720mm		H:900mm		H:1210mm	
CODE	WIDTH	CODE	WIDTH	CODE	WIDTH	CODE	WIDTH	CODE	WIDTH	CODE	WIDTH
RWOS50-2	500	RWOS50-3	600	RWOS30-5	300	RWOS30-7	300	RWOS30-9	300	RDC1/50	500
RWOS60-2	600	RWOS60-3	600	RWOS40-5	400	RWOS40-7	400	RWOS40-9	400	RDC1/60	600
RWOS80-2	800	RWOS80-3	800	RWOS45-5	450	RWOS45-7	450	RWOS45-9	450	MFC Carcase	
RWOS90-2	900	RWOS90-3	900	RWOS50-5	500	RWOS50-7	500	RWOS50-9	500	If 350mm deep carcass is required adjust code, e.g. RDC1/3550	
RWOS10-2	1000	RWOS10-3	1000	RWOS60-5	600	RWOS60-7	600	RWOS60-9	600		
MFC Carcase		MFC Carcase		RWOS80-5	800	RWOS80-7	800	RWOS80-9	800		
				RWOS90-5	900	RWOS90-7	900	RWOS90-9	900		
				RWOS10-5	1000	RWOS10-7	1000	RWOS10-9	1000		
				MFC Carcase		MFC Carcase		MFC Carcase			

LARDER

Single Door		Drawer Larder		'L' Shaped		Diagonal		Diagonal Walk-in Larder	
H:1970mm	WIDTH	H:2150mm	WIDTH	H:1970mm	*H:2150mm	H:1970mm	*H:2150mm	H:1970mm	*H:2150mm
CODE	WIDTH	CODE	WIDTH	CODE	WIDTH	CODE	WIDTH	CODE	WIDTH
RTLU30	300	RETLU30	300	TLUSD50	500	TDLU80	800	TCLU98	985x985
RTLU40	400	RETLU40	400	TLUSD60	600	TDLU10	1000	ETCLU98*	985x985
RTLU50	500	RETLU50	500					Bi-fold hinge system	
RTLU60	600	RETLU60	600						
TLU80	800	ETLU80	800						
TLU10	1000	ETLU10	1000						

PULL-OUT LARDER | INNER DRAWER LARDER | DOUBLE OVEN | SINGLE OVEN | SINGLE OVEN + COMPACT | COMPACT

Pull-out Larder		Inner Drawer Larder		Double Oven		Single Oven		Single Oven + Compact		Compact	
H:1970mm	*H:2150mm	H:1970mm	WIDTH	H:2150mm	WIDTH	H:1970mm	*H:2150mm	H:1970mm	*H:2150mm	H:1970mm	*H:2150mm
CODE	WIDTH	CODE	WIDTH	CODE	WIDTH	CODE	WIDTH	CODE	WIDTH	CODE	WIDTH
RTISPOL30	300	RTLID30	300	RETLD30	300	RTOHD60	600	RTOHS60	600	RTOHSC60	600
RTKPOL30	300	RTLID40	400	RETLD40	400	RTOHDD60	600	RTOHSD60	600	RETOHSC60*	600
Standard Mechanism inc.		RTLID50	500	RETLD50	500	RETOHDD60*	600	RETOHSD60*	600		
RETISPOL30*	300	RTLID60	600	RETLD60	600						
Kesseböhmer Mechanism											

TALL FRIDGE/FREEZER | TALL FRIDGE/FREEZER | BOX WINE RACKS | END SUPPORT PANELS | CARCASE MFC PANELS | PLINTH

Tall Fridge/Freezer		Tall Fridge/Freezer		Box Wine Racks		End Support Panels		Carcase MFC Panels		Plinth	
H:1970mm	WIDTH	H:2150mm	WIDTH	W:125mm / W:250mm*	HEIGHT	H:900mm	WIDTH	CODE <th>WXH</th> <th>CODE <th>WIDTH</th> </th>	WXH	CODE <th>WIDTH</th>	WIDTH
RTFF1/60	600	RETFF1/60	600	RWR125-7	720	ESP	600	1970/300	300x1970	PL	2940
RTFF4/60*	600	RETFF2/60	600	RWR250-7*	720	900/700	700	2150/560	560x2150	MFC Carcase	
*Doors undrilled		RETFF1U/60*	600	RWR125-9	900			2350/660	660x2350	PL/PSL	2740
RTFF1U/60*	600	RETFF2U/60*	600	RWR250-9*	900			720/300	300x720	Door Finish	
RTFF4U/60*	600			RWR125-1210	1210			900/2000	2000x900		
# For door on door appliances				WR125-1970	1970			900/300	300x900		
				WR250-1970*	1970			MFC Carcase			
								MFC Carcase			
								UG/**ET	1000x22		
								*Un-Glued 1m Carcase Edging			

PLANT ON END PANELS | FURNITURE ACCESSORIES | INTEGRATED DOORS | SPARE DOOR FITTINGS | GENERAL ACCS.

Plant on End Panels		Furniture Accessories		Integrated Doors		Spare Door Fittings		General Accs.	
CODE	WXH	CODE	WXH	CODE	WXH	CODE	WIDTH	CODE	WIDTH
2400/650/18PSL	650x2400	CP/PSL	146	INT4571	446x715	STPWN	Set of 2	LEGSET	Set of 4
900/350/18PSL	350x900			INT6071	596x715	Door Strapping Plates		Adjustable legs	
900/650/18PSL	650x900					SACC	Pk 50	14mm Self Adhesive Carcase Cover Caps	

Note: Furniture codes beginning with the letter 'R' are assembled (rigid), by removing the 'R' the units are supplied unassembled (flat-pack).

Note: Furniture codes beginning with the letter 'R' are assembled (rigid), by removing the 'R' the units are supplied unassembled (flat-pack).



SLAB  
PRICE GROUP 3  
**JUKO MATT**

Special sizes available  
contact us for further information

Colours Options [PG3]: Ash, Cloud and Graphite.



**HI-LINE BASE**

H:720mm CODE	WIDTH	CODE	WIDTH	H:720mm CODE	WIDTH	H:720mm CODE	WIDTH	H:720mm CODE	WIDTH	H:720mm CODE	WIDTH	H:720mm CODE	WIDTH
RBA15	150	R2BA60*	600	RBISPO15	150	RCDRBA30	300x300	RCRBA26	260	RABA360	360	R2BU30	300
RBA26	260	RBA70#	700	Standard Mechanism inc.				R2BU35	350	R2BU70#	700	R2BU40	400
RBA30	300	RBA80#	800	RBKPO15	150	Kesseböhmer Mechanism inc.				R2BU45	450	R2BU90#	900
RBA35	350	RBA90#	900	Kesseböhmer Mechanism inc.				R2BU50	500	R2BU10#	1000	R2BU60	600
RBA40	400	RBA10#	1000	Kesseböhmer Mechanism & Towel rail inc.									
RBA45	450	RBA12#	1200	*No muntin [2x300 doors]									
RBA50	500			#2 x Doors									
RBA60	600												

**LOW BASE**

H:575mm CODE	WIDTH	H:720mm CODE	WIDTH	H:720mm CODE	WIDTH	H:720mm CODE	WIDTH	H:720mm CODE	WIDTH	H:720mm CODE	WIDTH	H:720mm CODE	WIDTH	
RLBU30	300	RBAC830	800/300	RBAC950	900/500	BAC90	900x900	Bi-fold hinge system	RBD30	300	RBD80#	800	RBD80/1	800
RLBU40	400	RBAC80	800/400	RBAC960	900/600	Flatpack		RBD40	400	RBD90#	900	RBD90/1	900	
RLBU45	450	RBAC845	800/450	RBAC140	1000/400			RBD45	450	RBD10#	1000	RBD10/1	1000	
RLBU50	500	RBAC850	800/500	RBAC145	1000/450			RBD50	500	RBD12#	1200			
RLBU60	600	RBAC860	800/600	RBAC10	1000/500			RBD60	600	#2 x Doors				
RLBU80#	800	RBAC940	900/400	RBAC160	1000/600									
RLBU90#	900	RBAC945	900/450	RBAC12	1200/600									
RLBU10#	1000					Inc. 60x60mm Corner Post & Blanking Panel								
RLBU12#	1200													
#2 x Doors														

**DRAWERLINE SINK BASE CERAMIC SINK BASE DRAWERLINE CORNER BASE BUILT UNDER 2 DRAWER BASE 3 DRAWER BASE**

H:720mm CODE	WIDTH	H:460mm CODE	WIDTH	H:720mm CODE	WIDTH	H:720mm CODE	WIDTH	H:720mm CODE	WIDTH	H:720mm CODE	WIDTH	H:720mm CODE	WIDTH
RBD50	500	RBSU60	600	RBDC830	800/300	RBDC140	1000/400	RBU060	600	RBUM60	600	RBD250	500
RBD60	600	To suit a sink height of 260mm		RBDC80	800/400	RBDC145	1000/450	175mm drawer & 110mm filler		RBD260	600	RBD360	600
RBD70#	700			RBDC845	800/450	RBDC10	1000/500			RBD280	800	RBD380	800
RBD80#	800			RBDC850	800/500	RBDC160	1000/600			RBD290	900	RBD390	900
RBD90#	900			RBDC860	800/600	RBDC12	1200/600			RBD210	1000	RBD310	1000
RBD10#	1000			Inc. 60x60mm Corner Post & Blanking Panel									
RBD12#	1200												
#2 x Doors													

**4 DRAWER BASE 5 DRAWER BASE LOW WALL MEDIUM WALL**

H:720mm CODE	WIDTH	H:720mm CODE	WIDTH	H:575mm CODE	WIDTH	H:575mm CODE	WIDTH	H:720mm CODE	WIDTH	H:720mm CODE	WIDTH	H:720mm CODE	WIDTH
RBD450	500	RBD530	300	RWU30-5	300	R2WU60-5*	600	RAWU360-5	360	RWU26-7	260	R2WU60-7*	600
RBD460	600	RBD540	400	RWU40-5	400	RWU80-5#	800	Add 'X' to the end of the code for 350mm deep [650x650]		RWU30-7	300	RWU70-7#	700
RBD480	800	RBD545	450	RWU45-5	450	RWU90-5#	900			RWU35-7	350	RWU80-7#	800
RBD490	900	RBD550	500	RWU50-5	500	RWU10-5#	1000			RWU40-7	400	RWU90-7#	900
RBD410	1000	RBD560	600	RWU60-5	600	*No muntin [2 x 300 doors]				RWU45-7	450	RWU10-7#	1000
3x140mm, 1x283mm Drawers		RBD580	800	Add 'X' to the end of the code for 350mm deep						RWU50-7	500	*No muntin [2x300 doors]	
RBD450/175	500	RBD590	900							RWU60-7	600	#2x Doors	
RBD460/175	600	RBD510	1000							Add 'X' to the end of the code for 350mm deep			
4x175mm Drawers													

**MEDIUM WALL**

H:720mm CODE	WIDTH	H:720mm CODE	WIDTH	H:720mm CODE	WIDTH	H:720mm CODE	WIDTH	H:720mm CODE	WIDTH	H:720mm CODE	WIDTH	H:720mm CODE	WIDTH
RWG50-7	500	RCVD60-7	600x600	RCWL60-7	600x600	RWUC260-7	600	RAWU360-7	360	RCDWU30-7	300x300	RMWU60-7	600
RWG10-7	1000	Add 'X' to the end of the code for 350mm deep [650x650]		Bi-fold hinge system		Inc. 60x60mm Corner Post		Add 'X' to the end of the code for 350mm deep		283mm flap, 110mm filler; Mechanism inc.		RBFWU50-7	500
Add 'X' to the end of the code for 350mm deep													

Note: Furniture codes beginning with the letter 'R' are assembled (rigid), by removing the 'R' the units are supplied unassembled (flat-pack).

**TALL WALL HORIZONTAL WALL**

H:900mm CODE	WIDTH	CODE	WIDTH	H:900mm CODE	WIDTH	H:900mm CODE	WIDTH	H:900mm CODE	WIDTH	H:290mm CODE	WIDTH	H:360mm CODE	WIDTH
RWU30-9	300	R2WU60-9*	600	RCWD60-9	600x600	RCWL60-9	600x600	RAWU360-9	360	BWU6040-9	600	RHWU5029	500
RWU40-9	400	RWU80-9#	800	Add 'X' to the end of the code for 350mm deep [650x650]		Add 'X' to the end of the code for 350mm deep [650x650]		Add 'X' to the end of the code for 350mm deep		400mm Deep Flatpack		RHWU6029	600
RWU45-9	450	RWU90-9#	900									RHWU8029	800
RWU50-9	500	RWU10-9#	1000									RHWU9029	900
RWU60-9	600	*No muntin [2x300 doors]										RHWU1029	1000
#2 x Doors													
Add 'X' to the end of the code for 350mm deep													

**OPEN WALL**

H:290mm CODE	WIDTH	H:360mm CODE	WIDTH	H:575mm CODE	WIDTH	H:720mm CODE	WIDTH	H:900mm CODE	WIDTH	H:1210mm CODE	WIDTH	RMLU60	RMA160	LARDER	
RWOS50-2	500	RWOS50-3	500	RWOS30-5	300	RWOS30-7	300	RWOS30-9	300	RDC1/50	500	RMD060	RMOH560	RTLU30	300
RWOS60-2	600	RWOS60-3	600	RWOS40-5	400	RWOS40-7	400	RWOS40-9	400	RDC1/60	600			RTLU40	400
RWOS80-2	800	RWOS80-3	800	RWOS45-5	450	RWOS45-7	450	RWOS45-9	450	MFC Carcase				RTLU50	500
RWOS90-2	900	RWOS90-3	900	RWOS50-5	500	RWOS50-7	500	RWOS50-9	500	If 350mm deep carcase is required adjust code, e.g. RDC1/3550				TLU60	600
RWOS10-2	1000	RWOS10-3	1000	RWOS60-5	600	RWOS60-7	600	RWOS60-9	600					TLU80	800
MFC Carcase															
If 350mm deep carcase is required adjust code, e.g. RWOS1035-2															
If 350mm deep carcase is required adjust code, e.g. RWOS1035-3															
If 350mm deep carcase is required adjust code, e.g. RWOS1035-5															
If 350mm deep carcase is required adjust code, e.g. RWOS1035-7															
If 350mm deep carcase is required adjust code, e.g. RWOS1035-9															

**LARDER**

H:2150mm CODE	WIDTH	H:1970mm CODE	WIDTH	H:1970mm CODE	WIDTH	H:1970mm CODE	WIDTH	H:1970mm CODE	WIDTH	H:1970mm CODE	WIDTH	H:1970mm CODE	WIDTH	H:2150mm CODE	WIDTH
RETLU30	300	TDLU80	800	TCLU98	985x985	ETLU98*	985x985	TDWIL1144*	1144x1144	ETDCLU1003*	1003x1003	RTISPOL30	300	RTLID30	300
RETLU40	400	TDLU10	1000	Bi-fold hinge system								RTKPOL30	300	RTLID40	400
RETLU50	500	2x355 drawers										Standard Mechanism inc.	RTLID50	500	
RETLU60	600											RETISPOL30*	300	RTLID60	600
ETLU80	800											RETSPOL30*	300	RETID60	600
ETLU10	1000											Kesseböhmer Mechanism		1 x Standard, 4 x Deep drawers	

**DOUBLE OVEN SINGLE OVEN SINGLE OVEN + COMPACT COMPACT TALL FRIDGE/FREEZER BOX WINE RACKS**

H:1970mm CODE	WIDTH	H:1970mm CODE	WIDTH	H:1970mm CODE	WIDTH	H:1970mm CODE	WIDTH	H:1970mm CODE	WIDTH	H:2150mm CODE	WIDTH	H:2150mm CODE	WIDTH	H:2150mm CODE	WIDTH
RTOHD60	600	RTOHS60	600	RTOHSC60	600	RTOHC60	600	RTFF1/60	600	RTFF2/60	600	RTFF1U/60#	600	RTFF2U/60#	600
RTOHDD60	600	RTOHSD60	600	RTOHSC60*	600	RTOHC60*	600	*Doors undrilled						*For door on door appliances	
RETOHDD60*	600	RETOHS60*	600											1x Standard, 4x Deep drawers	

**END SUPPORT PANELS CARCASE MFC PANELS CORNICE / PELMET PLINTH**

H:900mm CODE	WIDTH	CODE	WXH	CODE	WXH	H:25mm CODE	LENGTH	H:25mm CODE	WIDTH	H:150mm CODE	WIDTH	H:150mm CODE	WXD	CODE	WIDTH
ESP	600	1970/300	300x1970	UG/*ET	1000x22	PCM/BM	3000	CCMS/BM	322x322	PL	2940	CPLS/BM	275x535	PST	3000
900/700	700	2150/560	560x2150	*Un-Glued 1m carcase edging				Matt		MFC Carcase		Matt		Use in conjunction with PL/BM	
MFC Carcase															
2350/660 660x2350															
720/300 300x720															
900/2000 2000x900															
900/300 300x900															
MFC Carcase															

**PLANT ON END PANELS FURNITURE ACCESSORIES INTEGRATED DOORS SPARE DOOR FITTINGS GENERAL ACCS.**

CODE	WXH	CODE	WXH	H:715mm CODE	WIDTH	CODE	WXH
2400/350/228M	350x2440	900/2400/228M	2400x900	CP/BM	60x60	INT4571	446x715
2400/650/228M	650x2440			INT6071	596x715		
900/650/228M	650x900						
910/1185/228M	1185x910						
Matt							

Note: Furniture codes beginning with the letter 'R' are assembled (rigid), by removing the 'R' the units are supplied unassembled (flat-pack).

SLAB  
PRICE GROUP 2  
**KOLT**

Special sizes available  
contact us for further information

Colours Options [PG2]: Ash Marble, Copper Blend, Dark Oak, Graphite Blend, Grey Blend, Grey Marble, Lead Marble, Natural Oak and White Oak.



**HI-LINE BASE** **LOW BASE**

Pull-Out				Splayed				LOW BASE									
H:720mm CODE	WIDTH	CODE	WIDTH	H:720mm CODE	WIDTH	H:720mm CODE	WIDTH	H:720mm CODE	WIDTH	H:720mm CODE	WIDTH	H:720mm CODE	WIDTH				
RBA15	150	R2BA60*	600	RBISPO15	150	RBA360	360	RSBU30	300	RSBU70#	700	RLBU30	300	RLBU80#	800		
RBA26	260	RBA70#	700	Standard Mechanism inc.				RSBU35	350	RSBU80#	800	RLBU40	400	RLBU90#	900		
RBA30	300	RBA80#	800	RBKPO15	150	Kesseböhmer Mechanism inc.				RSBU40	400	RSBU90#	900	RLBU10#	1000		
RBA35	350	RBA90#	900	RBKTP015	150	Kesseböhmer Mechanism & Towel rail inc.				RSBU45	450	RSBU10#	1000	RLBU12#	1200		
RBA40	400	RBA10#	1000					RSBU50	500	# 2 x Doors		RLBU50	500	# 2 x Doors			
RBA45	450	RBA12#	1200					RSBU60	600					RLBU60	600		
RBA50	500	*No muntin [2x300 doors]															
RBA60	600	# 2 x Doors															

**HI-LINE CORNER BASE** **DRAWERLINE BASE**

HI-LINE CORNER BASE				DRAWERLINE BASE			
H:720mm CODE	WIDTH	CODE	WIDTH	H:720mm CODE	WIDTH	H:720mm CODE	WIDTH
RBAC830	800/300	RBAC950	900/500	BAC90	900x900	CDA90	900x900
RBAC80	800/400	RBAC960	900/600	Bi-fold hinge system Flatpack			
RBAC845	800/450	RBAC140	1000/400	RBD30	300	RBD80#	800
RBAC850	800/500	RBAC145	1000/450	RBD40	400	RBD90#	900
RBAC860	800/600	RBAC10	1000/500	RBD45	450	RBD10#	1000
RBAC940	900/400	RBAC160	1000/600	RBD50	500	RBD12#	1200
RBAC945	900/450	RBAC12	1200/600	RBD60	600	# 2 x Doors	

**DRAWERLINE SINK BASE** **BUILT UNDER**

DRAWERLINE SINK BASE				BUILT UNDER				
H:720mm CODE	WIDTH	CODE	WIDTH	H:720mm CODE	WIDTH	H:720mm CODE	WIDTH	
RBDF50	500	RBSU60	600	Oven	RBU060	600	RBUM60	600
RBDF60	600	To suit a sink height of 260mm		Microwave	175mm drawer & 110mm filler			
RBDF80#	800					RBUM60	600	
RBDF90#	900					RBUM60	600	
RBDF10#	1000					RBUM60	600	
RBDD10**	1000					RBUM60	600	
RBDD12**	1200					RBUM60	600	

**3 DRAWER BASE** **LOW WALL**

3 DRAWER BASE				LOW WALL			
H:720mm CODE	WIDTH	CODE	WIDTH	H:720mm CODE	WIDTH	H:575mm CODE	WIDTH
RBD350	500	RBD450	500	RBD530	300	RWU30-5	300
RBD360	600	RBD460	600	RBD540	400	RWU40-5	400
RBD380	800	RBD480	800	RBD545	450	RWU45-5	450
RBD390	900	RBD490	900	RBD550	500	RWU50-5	500
RBD310	1000	RBD410	1000	RBD560	600	RWU60-5	600
1x140mm, 2x283mm Drawers		3x140mm, 1x283mm Drawers		RBD580	800	*No muntin [2 x 300 doors]	
RBD350/175	500	RBD450/175	500	RBD590	900	# 2 x Doors	
RBD360/175	600	RBD460/175	600	RBD510	1000	Add 'X' to the end of the code for 350mm deep	

**MEDIUM WALL**

MEDIUM WALL			
H:720mm CODE	WIDTH	CODE	WIDTH
RWU26-7	260	R2WU60-7*	600
RWU30-7	300	RWU70-7#	700
RWU35-7	350	RWU80-7#	800
RWU40-7	400	RWU90-7#	900
RWU45-7	450	RWU10-7#	1000
RWU50-7	500	*No muntin [2x300 doors]	
RWU60-7	600	#2x Doors	

**TALL WALL** **HORIZONTAL WALL**

Diagonal Corner				'L' Shaped Corner				Splayed				Boiler Wall			
H:900mm CODE	WIDTH	CODE	WIDTH	H:900mm CODE	WIDTH	H:900mm CODE	WIDTH	H:900mm CODE	WIDTH	H:900mm CODE	WIDTH	H:290mm CODE	WIDTH	H:360mm CODE	WIDTH
RWU30-9	300	R2WU60-9*	600	RCWD60-9	600x600	RCWL60-9	600x600	RAWU360-9	360	BWU6040-9	600	RHWU5029	500	RHWU5036	500
RWU40-9	400	RWU80-9#	800	Add 'X' to the end of the code for 350mm deep [650x650]				Add 'X' to the end of the code for 350mm deep [650x650]				400mm Deep Flatpack			
RWU45-9	450	RWU90-9#	900									RHWU6029			
RWU50-9	500	RWU10-9#	1000									RHWU8029			
RWU60-9	600	*No muntin [2x300 doors]										RHWU9029			
												RHWU1029			

**OPEN WALL** **MIDI UNITS**

OPEN WALL				MIDI UNITS			
H:290mm CODE	WIDTH	H:360mm CODE	WIDTH	H:720mm CODE	WIDTH	H:900mm CODE	WIDTH
RWOS50-2	500	RWOS50-3	500	RWOS30-5	300	RWOS30-7	300
RWOS60-2	600	RWOS60-3	600	RWOS40-5	400	RWOS40-7	400
RWOS80-2	800	RWOS80-3	800	RWOS45-5	450	RWOS45-7	450
RWOS90-2	900	RWOS90-3	900	RWOS50-5	500	RWOS50-7	500
RWOS10-2	1000	RWOS10-3	1000	RWOS60-5	600	RWOS60-7	600
MFC Carcase				MFC Carcase			

**LARDER** **PULL-OUT LARDER**

LARDER				PULL-OUT LARDER			
H:1970mm CODE	WIDTH	H:2150mm CODE	WIDTH	H:1970mm CODE	WIDTH	H:2150mm CODE	WIDTH
RTL30	300	RETL30	300	RTL50	500	RETL50	500
RTL40	400	RETL40	400	RTL60	600	RETL60	600
RTL80	800	ETLU80	800	TLU80	800	ETLU80	800
TLU10	1000	ETLU10	1000	TLU10	1000	ETLU10	1000

**INNER DRAWER LARDER** **DOUBLE OVEN**

INNER DRAWER LARDER				DOUBLE OVEN			
H:1970mm CODE	WIDTH	H:2150mm CODE	WIDTH	H:1970mm CODE	WIDTH	H:2150mm CODE	WIDTH
RTLID30	300	RETLID30	300	RTOHD60	600	RTOHS60	600
RTLID40	400	RETLID40	400	RTOHD60*	600	RTOHS60*	600
RTLID50	500	RETLID50	500				
RTLID60	600	RETLID60	600				

**TALL FRIDGE/FREEZER** **BOX WINE RACKS**

TALL FRIDGE/FREEZER				BOX WINE RACKS			
H:2150mm CODE	WIDTH	H:2150mm CODE	WIDTH	W:125mm / W:250mm*	H:900mm CODE	WIDTH	CODE
RTFF1/60	600	RWR125-7	720	ESP	600	900/700	700
RTFF2/60	600	RWR250-7*	720	MFC Carcase			
RTFF3/60*	600	RWR125-9	900				
RTFF10/60#	600	RWR250-9*	900				
RTFF20/60#	600	RWR125-1210	1210				
RTFF30/60#	600	WR125-1970	1970				

**PLINTH** **PLANT ON END PANELS**

PLINTH				PLANT ON END PANELS			
CODE	WIDTH	CODE	WIDTH	CODE	WXH	CODE	WXH
PST	3000	2400/650/18MK	650x2400	900/1200/18MK	1200x900	900/1200/18MK	1200x900
				Door Finish			
				940/375/18MK 375x940			

Note: Furniture codes beginning with the letter 'R' are assembled (rigid), by removing the 'R' the units are supplied unassembled (flat-pack).

SLAB  
PRICE GROUP 6 + 7  
**LANGLEY**  
PAINT TO ORDER

Special sizes available  
contact us for further information

Colour Options [PG6]: Auburn, Black, Bone, Dusty Rose, Cashmere, Coal, Cotton, Fern, Forest, Mink, Mist, Moss, Navy, Putty, Riptide, Sea Salt, Smoke, Space, Thyme and Twilight.

Bespoke Colour Option [PG7]



HI-LINE BASE LOW BASE HI-LINE CORNER BASE

Pull-Out		Splayed		Shallow Base [300mm deep]		'L' Shaped		Diagonal	
H:720mm CODE	WIDTH	H:720mm CODE	WIDTH	H:720mm CODE	WIDTH	H:720mm CODE	WIDTH	H:720mm CODE	WIDTH
RBA15	150	R2BA60*	600	RBSP015	150	RBA360	360	RSBU30	300
RBA30	300	RBA70#	700	RBSP015	150			RSBU35	350
RBA35	350	RBA80#	800	RBKPO15	150			RSBU40	400
RBA40	400	RBA90#	900	Kesseböhmer Mechanism inc.				RSBU45	450
RBA45	450	RBA10#	1000	RBKTP015	150			RSBU50	500
RBA50	500	RBA12#	1200	Kesseböhmer Mechanism & Towel rail inc.				RSBU60	600
RBA60	600	*No muntin [2x300 doors] # 2 x Doors						RSBU70#	700
								RSBU80#	800
								RSBU90#	900
								RSBU10#	1000

HI-LINE CORNER BASE DRAWERLINE BASE DRAWERLINE SINK BASE CERAMIC SINK BASE DRAWERLINE CORNER BASE BUILT UNDER

Single Top Drawer		Oven	
H:720mm CODE	WIDTH	H:720mm CODE	WIDTH
RBAC830	800/300	RBAC950	900/500
RBAC80	800/400	RBAC960	900/600
RBAC845	800/450	RBAC1000	1000/450
RBAC850	800/500	RBAC145	1000/450
RBAC860	800/600	RBAC10	1000/500
RBAC940	900/400	RBAC160	1000/600
RBAC945	900/450	RBAC12	1200/600

2 DRAWER BASE 3 DRAWER BASE 4 DRAWER BASE 5 DRAWER BASE LOW WALL

Diagonal Corner		Splayed	
H:720mm CODE	WIDTH	H:720mm CODE	WIDTH
RBD250	500	RBD350	500
RBD260	600	RBD360	600
RBD280	800	RBD380	800
RBD290	900	RBD390	900
RBD210	1000	RBD310	1000

MEDIUM WALL

Glazed Door		Diagonal Corner		'L' Shaped Corner		Conventional Corner		Splayed		Microwave Wall	
H:720mm CODE	WIDTH	H:720mm CODE	WIDTH	H:720mm CODE	WIDTH	H:720mm CODE	WIDTH	H:720mm CODE	WIDTH	H:720mm CODE	WIDTH
RWU30-7	300	R2WU60-7*	600	RCWD60-7	600x600	RCWL60-7	600x600	RWUC60-7	600	RMWU60-7	600
RWU35-7	350	RWU70-7#	700	Add 'X' to the end of the code for 350mm deep [650x650]		Add 'X' to the end of the code for 350mm deep [650x650]		Add 'X' to the end of the code for 350mm deep [650x650]		Add 'X' to the end of the code for 350mm deep [650x650]	

MEDIUM WALL TALL WALL

Bi-Fold		Glazed Door		Diagonal Corner		Splayed		Boiler Wall	
H:720mm CODE	WIDTH	H:900mm CODE	WIDTH	H:720mm CODE	WIDTH	H:900mm CODE	WIDTH	H:900mm CODE	WIDTH
RBFWU50-7	500	RWU30-9	300	R2WU60-9*	600	RWGR50-9*	500	RCWD60-9	600x600
RBFWU60-7	600	RWU40-9	400	RWU80-9*	800	RWGR10-9*	1000	Add 'X' to the end of the code for 350mm deep [650x650]	

Note: Furniture codes beginning with the letter 'R' are assembled (rigid), by removing the 'R' the units are supplied unassembled (flat-pack).

HORIZONTAL WALL GLAZED DRESSER OPEN WALL

H:290mm		H:360mm		H:1210mm		H:290mm		H:360mm		H:575mm		H:720mm		H:900mm		H:1210mm	
CODE	WIDTH	CODE	WIDTH	CODE	WIDTH	CODE	WIDTH	CODE	WIDTH	CODE	WIDTH	CODE	WIDTH	CODE	WIDTH	CODE	WIDTH
RHWU5029	500	RHWU5036	500	RDRR1/50*	500	RWOS50-2	500	RWOS50-3	500	RWOS30-5	300	RWOS30-7	300	RWOS30-9	300		
RHWU6029	600	RHWU6036	600	*Reeded glass		RWOS60-2	600	RWOS60-3	600	RWOS40-5	400	RWOS40-7	400	RWOS40-9	400		

MIDI UNITS LARDER

RMLU60		RMA160		RMD060		RMOH560		Single Door		Drawer Larder		'L' Shaped		Diagonal Walk-in Larder	
H:1250mm CODE	WIDTH	H:1250mm CODE	WIDTH	H:1250mm CODE	WIDTH	H:1250mm CODE	WIDTH	H:1250mm CODE	WIDTH	H:1250mm CODE	WIDTH	H:1250mm CODE	WIDTH	H:1250mm CODE	WIDTH
RMLU60	600	RMA160	600	RMD060	600	RMOH560	600	RTLU30	300	RETLU30	300	RTLUD50	500	RTLUD60	600

LARDER PULL-OUT LARDER INNER DRAWER LARDER DOUBLE OVEN SINGLE OVEN SINGLE OVEN + COMPACT

Diagonal		PULL-OUT LARDER		INNER DRAWER LARDER		DOUBLE OVEN		SINGLE OVEN		SINGLE OVEN + COMPACT	
H:1970mm CODE	WIDTH	H:1970mm CODE	WIDTH	H:1970mm CODE	WIDTH	H:1970mm CODE	WIDTH	H:1970mm CODE	WIDTH	H:1970mm CODE	WIDTH
TDCLU1003	1003x1003	RTSPOL30	300	RTLID30	300	RETLD30	300	RTOHD60	600	RTOH560	600

COMPACT TALL FRIDGE/FREEZER BOX WINE RACKS END SUPPORT PANELS CARCASE MFC PANELS CORNICE

RTOHC60		RTFF1/60		RETFF1/60		RW125-7		ESP		1970/300		2150/560		2350/660		720/300		900/2000		900/300	
H:1970mm CODE	WIDTH	H:1970mm CODE	WIDTH	H:1970mm CODE	WIDTH	H:1970mm CODE	HEIGHT	H:900mm CODE	WIDTH	CODE	WXH	CODE	WXH	CODE	WXH	CODE	WXH	CODE	WXH	CODE	WXH
RTOHC60	600	RTFF1/60	600	RETFF1/60	600	RWR125-7	720	ESP	600	1970/300	300x1970	2150/560	560x2150	2350/660	660x2350	720/300	300x720	900/2000	2000x900	900/300	300x900

COMBI PLINTH PLANT ON END PANELS

PCMB		PL		PST		DECPL/B		22mm Plain		22mm Plain Breakfast Bar Back Panel	
H:28mm CODE	LENGTH	CODE	WIDTH	CODE	WIDTH	H:170mm CODE	WIDTH	CODE	WXH	CODE	WXH
PCMB	3000	PL	2940	PST	3000	DECPL/B	3000	2440/350/22B	350x2440	900/1170/22B	1170x900

FURNITURE ACCESSORIES INTEGRATED DOORS WINE CAB DOORS SPARE DOOR FITTINGS GENERAL ACCS.

Corner Post [Spare]		Mantle Shelf		Decorative Corbel [Single]		Door Hung Spice Rack		Undrilled		WINE CAB DOORS		SPARE DOOR FITTINGS		GENERAL ACCS.	
H:715mm CODE	WIDTH	H:25mm CODE	WXD	H:219mm CODE	WXD	H:1050mm CODE	WXD	CODE	WXH	CODE	WXH	[Hettich Soft Close]		CODE	DESCRIPTION
CPB**10	146	MS/B	2400x200	COR/B	107x95	DHSR/BNO	350x106	INT4571	446x715	WCD607	715x596	CHINGE90	90 degree [Pair]	STPNW	Set of 2 Door Strapping Plates

Note: Furniture codes beginning with the letter 'R' are assembled (rigid), by removing the 'R' the units are supplied unassembled (flat-pack).

SLAB  
PRICE GROUP 2  
**LYDE**  
Special sizes available  
contact us for further information  
Colours Options [PG2]: Dust Grey, Graphite, Grey, Savanna and White.



**HI-LINE BASE**

H:720mm CODE	WIDTH	CODE	WIDTH
RBA15	150	RZBA60*	600
RBA26	260	RBA70*	700
RBA30	300	RBA80*	800
RBA35	350	RBA90*	900
RBA40	400	RBA10*	1000
RBA45	450	RBA12*	1200
RBA50	500	*No muntin [2x300 doors]	
RBA60	600	*2 x Doors	

**Pull-Out**

H:720mm CODE	WIDTH
RBISPO15	150

**Curved Door**

H:720mm CODE	WIDTH
RCDBA30	300x300

H:720mm CODE	WIDTH	H:720mm CODE	WIDTH
RSBU30	300	RLBU30	300
RSBU35	350	RLBU40	400
RSBU40	400	RLBU45	450
RSBU45	450	RLBU50	500
RSBU50	500	RLBU60	600
RSBU60	600	RLBU80*	800
RSBU70*	700	RLBU90*	900
RSBU80*	800	RLBU10*	1000
RSBU90*	900	RLBU12*	1200
RSBU10*	1000		

\*2 x Doors

**LOW BASE**

**HI-LINE CORNER BASE**

H:720mm CODE	WIDTH	H:720mm CODE	WIDTH
RBAC30	300	RBAC950	900/500
RBAC80	800/300	RBAC960	900/600
RBAC845	800/400	RBAC140	1000/400
RBAC850	800/500	RBAC145	1000/450
RBAC860	800/600	RBAC10	1000/500
RBAC940	900/400	RBAC160	1000/600
RBAC945	900/450	RBAC12	1200/600

Inc. 60x60mm Corner Post & Blanking Panel

**HI-LINE CORNER BASE**

**'L' Shaped**

H:720mm CODE	WIDTH
BAC90	900x900

Bi-fold hinge system  
Flatpack

**Diagonal**

H:720mm CODE	WIDTH
CDA90	900x900

Flatpack

**DRAWERLINE BASE**

H:720mm CODE	WIDTH	CODE	WIDTH
RBD30	300	RBD80*	800
RBD40	400	RBD90*	900
RBD45	450	RBD10*	1000
RBD50	500	RBD12*	1200
RBD60	600	*2 x Doors	

**DRAWERLINE SINK BASE**

**Single Top Drawer**

H:720mm CODE	WIDTH	H:720mm CODE	WIDTH
RBD80/1	800	RBDF50	500
RBD90/1	900	RBDF60	600
RBD10/1	1000	RBDF80*	800
		RBDF90*	900

\*One working drawer  
\*2 x Doors

**CERAMIC SINK BASE**

H:460mm CODE	WIDTH	H:720mm CODE	WIDTH
RBSU60	600	RBDC830	800/300
To suit a sink height of 260mm		RBDC80	800/400
		RBDC845	800/450
		RBDC850	800/500
		RBDC860	800/600

**DRAWERLINE CORNER BASE**

H:720mm CODE	WIDTH	H:720mm CODE	WIDTH
RBDC140	1000/400	RBDC12	1200/600
RBDC145	1000/450		
RBDC10	1000/500		
RBDC160	1000/600		

Inc. 60x60mm Corner Post & Blanking Panel

**BUILT UNDER**

H:720mm CODE	WIDTH	H:720mm CODE	WIDTH
RBUM60	600	RBUM60	600

175mm drawer & 110mm filler

**4 DRAWER BASE**

H:720mm CODE	WIDTH	H:720mm CODE	WIDTH
RBD450	500	RBD530	300
RBD460	600	RBD540	400
RBD480	800	RBD545	450
RBD490	900	RBD550	500
RBD410	1000	RBD560	600
3x140mm, 1x283mm Drawers		RBD580	800
RBD450/175	500	RBD590	900
RBD460/175	600	RBD510	1000
4x175mm Drawers			

**5 DRAWER BASE**

H:720mm CODE	WIDTH	H:575mm CODE	WIDTH
RBD530	300	RWU30-5	300
RBD540	400	RWU40-5	400
RBD545	450	RWU45-5	450
RBD550	500	RWU50-5	500
RBD560	600	RWU60-5	600
RBD580	800	RZU60-5*	600
RBD590	900	RWU80-5*	800
RBD510	1000	RWU90-5*	900
		RWU10-5*	1000

\*No muntin [2 x 300 doors]  
\*2 x Doors  
Add 'X' to the end of the code for 350mm deep

**MEDIUM WALL**

**Diagonal Corner**

H:575mm CODE	WIDTH	H:720mm CODE	WIDTH
RCWD60-5	600x600	RWU26-7	260

Add 'X' to the end of the code for 350mm deep

**Splayed**

H:720mm CODE	WIDTH	H:720mm CODE	WIDTH
RAWU360-5	360	RWU30-7	300

Add 'X' to the end of the code for 350mm deep

**'L' Shaped Corner**

H:720mm CODE	WIDTH	H:720mm CODE	WIDTH
RCWL60-7	600x600	RWU35-7	350

Add 'X' to the end of the code for 350mm deep

**MEDIUM WALL**

H:720mm CODE	WIDTH	H:720mm CODE	WIDTH
RWUC260-7	600	RMWU60-7	600

Inc. 60x60mm Corner Post  
Add 'X' to the end of the code for 350mm deep

**Conventional Corner**

H:720mm CODE	WIDTH	H:720mm CODE	WIDTH
RAWU360-7	360	RBFWU50-7	500

Add 'X' to the end of the code for 350mm deep

**Splayed**

H:720mm CODE	WIDTH	H:720mm CODE	WIDTH
RCWU30-7	300x300	RBFWU60-7	600

Add 'X' to the end of the code for 350mm deep

**Curved Door**

H:720mm CODE	WIDTH	H:720mm CODE	WIDTH
RMWU60-7	600	RBFWU80-7	800

Add 'X' to the end of the code for 350mm deep

**Curved Return [300mm deep]**

H:720mm CODE	WIDTH	H:720mm CODE	WIDTH
RCRBA26	260	RBFWU90-7	900

Add 'X' to the end of the code for 350mm deep

**Microwave Wall**

H:720mm CODE	WIDTH	H:720mm CODE	WIDTH
RMWU60-7	600	RBFWU10-7	1000

283mm flap, 110mm filler; Mechanism inc.  
Add 'X' to the end of the code for 350mm deep

**Bi-Fold**

H:720mm CODE	WIDTH	H:900mm CODE	WIDTH
RWU30-9	300	RWU40-9	400
RWU40-9	400	RWU45-9	450
RWU50-9	500	RWU50-9	500
RWU60-9	600	RWU60-9	600

\*No muntin [2x300 doors]  
\*2 x Doors  
Add 'X' to the end of the code for 350mm deep

**TALL WALL**

H:900mm CODE	WIDTH	H:900mm CODE	WIDTH
RWU30-9	300	RZU60-9*	600
RWU40-9	400	RWU80-9*	800
RWU45-9	450	RWU90-9*	900
RWU50-9	500	RWU10-9*	1000
RWU60-9	600	*No muntin [2x300 doors]	

#2 x Doors  
Add 'X' to the end of the code for 350mm deep

Note: Furniture codes beginning with the letter 'R' are assembled (rigid), by removing the 'R' the units are supplied unassembled (flat-pack).

**TALL WALL**

H:900mm CODE	WIDTH	H:900mm CODE	WIDTH
RCWD60-9	600x600	RCWL60-9	600x600

Add 'X' to the end of the code for 350mm deep [650x650]

H:900mm CODE	WIDTH	H:900mm CODE	WIDTH
RAWU360-9	360	RAWU360-9	360

Add 'X' to the end of the code for 350mm deep

H:900mm CODE	WIDTH	H:900mm CODE	WIDTH
BWU6040-9	600	BWU6040-9	600

400mm Deep Flatpack

**HORIZONTAL WALL**

H:290mm CODE	WIDTH	H:360mm CODE	WIDTH
RHWU5029	500	RHWU5036	500
RHWU6029	600	RHWU6036	600
RHWU8029	800	RHWU8036	800
RHWU9029	900	RHWU9036	900
RHWU1029	1000	RHWU1036	1000

Add 'X' to the end of the code for 350mm deep

H:290mm CODE	WIDTH	H:360mm CODE	WIDTH
RWOS50-2	500	RWOS50-3	500
RWOS60-2	600	RWOS60-3	600
RWOS80-2	800	RWOS80-3	800
RWOS90-2	900	RWOS90-3	900
RWOS10-2	1000	RWOS10-3	1000

MFC Carcase

If 350mm deep carcass is required adjust code, e.g. RWOS1035-2

If 350mm deep carcass is required adjust code, e.g. RWOS1035-3

**OPEN WALL**

H:575mm CODE	WIDTH	H:720mm CODE	WIDTH
RWOS30-5	300	RWOS30-7	300
RWOS40-5	400	RWOS40-7	400
RWOS45-5	450	RWOS45-7	450
RWOS50-5	500	RWOS50-7	500
RWOS60-5	600	RWOS60-7	600
RWOS80-5	800	RWOS80-7	800
RWOS90-5	900	RWOS90-7	900
RWOS10-5	1000	RWOS10-7	1000

MFC Carcase

If 350mm deep carcass is required adjust code, e.g. RWOS1035-5

H:720mm CODE	WIDTH	H:900mm CODE	WIDTH
RWOS30-9	300	RWOS30-9	300
RWOS40-9	400	RWOS40-9	400
RWOS45-9	450	RWOS45-9	450
RWOS50-9	500	RWOS50-9	500
RWOS60-9	600	RWOS60-9	600
RWOS80-9	800	RWOS80-9	800
RWOS90-9	900	RWOS90-9	900
RWOS10-9	1000	RWOS10-9	1000

MFC Carcase

If 350mm deep carcass is required adjust code, e.g. RWOS1035-7

H:1210mm CODE	WIDTH
RDC1/50	500
RDC1/60	600

MFC Carcase

If 350mm deep carcass is required adjust code, e.g. RDC1/3550

**MIDI UNITS**

H:1250mm CODE	WIDTH	H:1250mm CODE	WIDTH
RMLU60	600	RMLU60	600
RMA160	600	RMA160	600
RMD060	600	RMD060	600
RMOH560	600	RMOH560	600

**LARDER**

H:1970mm CODE	WIDTH	H:2150mm CODE	WIDTH
RTLJ30	300	RETLJ30	300
RTLJ40	400	RETLJ40	400
RTLJ50	500	RETLJ50	500
RTLJ60	600	RETLJ60	600
TLU80	800	ETLU80	800
TLU10	1000	ETLU10	1000

**LARDER**

H:1970mm CODE	WIDTH	H:1970mm CODE	WIDTH
TDLU80	800	TDLU1003	1003x1003
TDLU10	1000	ETDLU1003*	1003x1003

2x355 drawers

H:1970mm CODE	WIDTH	H:1970mm CODE	WIDTH
TCLU98	985x985	RTISPOL30	300
ETCLU98*	985x985	RTKPOL30	300
	Bi-fold hinge system	Standard Mechanism inc.	
		RETISPOL30*	300
		RETKPOL30*	300

1 x Standard, 4 x Deep drawers

H:1970mm CODE	WIDTH	H:1970mm CODE	WIDTH
TDWIL1144	1144x1144	RRLID30	300
ETDWIL1144*	1144x1144	RRLID40	400
		RRLID50	500
		RRLID60	600

1 x Standard, 4 x Deep drawers

H:1970mm CODE	WIDTH	H:1970mm CODE	WIDTH
RTISPOL30	300	RETID30	300
RTKPOL30	300	RETID40	400
Standard Mechanism inc.		RETID50	500
RETISPOL30*	300	RETID60	600
RETKPOL30*	300		

Kesseböhmer Mechanism inc.

**SINGLE OVEN**

H:1970mm CODE	WIDTH	H:1970mm CODE	WIDTH
ROHS60	600	RETOHSC60*	600
ROHSD60	600	RETOHSC60*	600
RETOHS60*	600		

**SINGLE OVEN + COMPACT**

H:1970mm CODE	WIDTH	H:1970mm CODE	WIDTH
RTFFF1/60	600	RTFFF1U/60*	600
RTFFF2/60	600	RTFFF2U/60*	600
RTFFF4/60*	600		
RTFFF1U/60*	600		
RTFFF2U/60*	600		
RTFFF4U/60*	600		

\*Doors undrilled  
\*For door on door appliances

**COMPACT**

H:1970mm CODE	WIDTH	H:1970mm CODE	WIDTH
RETOHC60	600	RETOHC60*	600

**TALL FRIDGE/FREEZER**

H:1970mm CODE	WIDTH	H:2150mm CODE	WIDTH
RTRF1/60	600	RTFFF1/60	600
RTRF2/60	600	RTFFF2/60	600
RTRF4/60*	600	RTFFF4U/60*	600
RTFFF1U/60*	600		
RTFFF2U/60*	600		
RTFFF4U/60*	600		

\*Doors undrilled  
\*For door on door appliances

**BOX WINE RACKS**

W:125mm
---------

SLAB  
PRICE GROUP 2  
**VIRA**  
Special sizes available  
contact us for further information

Colours Options [PG2]: Anthracite, Black, Blush, Fern, Fjord, Grey, Hunter, Indigo, Mussel, Navy, Porcelain and Terracotta.

**HI-LINE BASE**

H:720mm CODE	WIDTH	CODE	WIDTH
RBA15	150	R2BA60*	600
RBA26	260	RBA70*	700
RBA30	300	RBA80*	800
RBA35	350	RBA90*	900
RBA40	400	RBA10*	1000
RBA45	450	RBA12*	1200
RBA50	500	*No muntin [2x300 doors] # 2 x Doors	
RBA60	600		

**LOW BASE**   **HI-LINE CORNER BASE**

H:720mm CODE	WIDTH	H:720mm CODE	WIDTH
RBISPO15	150	RCDBA30	300x300
RBKPO15	150	RSBU30	300
RKPTPO15	150	RSBU35	350
		RSBU40	400
		RSBU45	450
		RSBU50	500
		RSBU60	600

**HI-LINE CORNER BASE**

H:720mm CODE	WIDTH	H:720mm CODE	WIDTH
BAC90	900x900	CDA90	900x900
*Bi-fold hinge system Flatpack			

**DRAWERLINE SINK BASE**   **CERAMIC SINK BASE**   **DRAWERLINE CORNER BASE**

H:720mm CODE	WIDTH	H:720mm CODE	WIDTH
RBD30	300	RBD80*	800
RBD40	400	RBD90*	900
RBD45	450	RBD10*	1000
RBD50	500	RBD12*	1200
RBD60	600	*No muntin # 2 x Doors	

**BUILT UNDER**   **2 DRAWER BASE**   **3 DRAWER BASE**   **4 DRAWER BASE**   **5 DRAWER BASE**   **LOW WALL**

H:720mm CODE	WIDTH	H:720mm CODE	WIDTH
RBW060	600	RBD250	500
		RBD360	600
		RBD380	800
		RBD390	900
		RBD210	1000
		RBD310	1000
		RBD350/175	500
		RBD360/175	600

**MEDIUM WALL**

H:720mm CODE	WIDTH	H:720mm CODE	WIDTH
RWU26-7	260	R2WU60-7*	600
RWU30-7	300	RWU70-7*	700
RWU35-7	350	RWU80-7*	800
RWU40-7	400	RWU90-7*	900
RWU45-7	450	RWU10-7*	1000
RWU50-7	500	*No muntin [2x300 doors] # 2 x Doors	
RWU60-7	600		

**MEDIUM WALL**   **TALL WALL**

H:720mm CODE	WIDTH	H:900mm CODE	WIDTH
RBFWU50-7	500	RWU30-9	300
RBFWU60-7	600	RWU40-9	400
RBFWU80-7	800	RWU45-9	450
RBFWU90-7	900	RWU50-9	500
RBFWU10-7	1000	RWU60-9	600

**MEDIUM WALL**   **TALL WALL**

H:720mm CODE	WIDTH	H:900mm CODE	WIDTH
RBFWU50-7	500	RWU30-9	300
RBFWU60-7	600	RWU40-9	400
RBFWU80-7	800	RWU45-9	450
RBFWU90-7	900	RWU50-9	500
RBFWU10-7	1000	RWU60-9	600

**HORIZONTAL WALL**

H:290mm CODE	WIDTH	H:360mm CODE	WIDTH
RHWU5029	500	RHWU5036	500
RHWU6029	600	RHWU6036	600
RHWU8029	800	RHWU8036	800
RHWU9029	900	RHWU9036	900
RHWU1029	1000	RHWU1036	1000

**GLAZED DRESSER**   **OPEN WALL**

H:1210mm CODE	WIDTH	H:290mm CODE	WIDTH
RDR2/50	500	RWOS50-2	500
1 Drawer		RWOS60-2	600
Add 'X' to the end of the code for 350mm deep		RWOS80-2	800
		RWOS90-2	900
		RWOS10-2	1000
		MFC Carcase	

**LARDER**   **PULL-OUT LARDER**

H:1970mm CODE	WIDTH	H:2150mm CODE	WIDTH
RTL30	300	RETL30	300
RTL40	400	RETL40	400
RTL50	500	RETL50	500
RTL60	600	RETL60	600
TLU80	800	ETLU80	800
TLU10	1000	ETLU10	1000

**INNER DRAWER LARDER**   **DOUBLE OVEN**   **SINGLE OVEN**   **SINGLE OVEN + COMPACT**   **COMPACT**   **TALL FRIDGE/FREEZER**

H:1970mm CODE	WIDTH	H:1970mm CODE	WIDTH
RTL30	300	RTL40	400
RTL50	500	RTL60	600
RTL80	800	RTL10	1000

**TALL FRIDGE/FREEZER**   **BOX WINE RACKS**   **END SUPPORT PANELS**   **CARCASE MFC PANELS**   **CORNICE**

H:2150mm CODE	WIDTH	W:125mm / W:250mm* CODE	HEIGHT
RETF1/60	600	RWR125-7	720
RETF2/60	600	RWR250-7*	720
RETF1U/60*	600	RWR125-9	900
RETF2U/60*	600	RWR250-9*	900
* For door on door appliances		RWR125-1210	1210
		WR125-1970	1970
		WR250-1970*	1970

**CORNICE**   **PLINTH**   **Curved Plinth Section**   **Clear Sealing Strip**   **PLANT ON END PANELS**   **FURNITURE ACCESSORIES**

H:30mm CODE	WIDTH	H:150mm CODE	WIDTH
CCMS/TM	318x318	PL	2940
Use in conjunction with PCM/TM		PL/TM	3000

**FURNITURE ACCESSORIES**   **INTEGRATED DOORS**   **SPARE DOOR FITTINGS**   **GENERAL ACCESSORIES**

H:3000mm CODE	WIDTH	H:30mm CODE	WXH
RP/TM	80x80	RPCM/TM	80x80
Door Finish		Use in conjunction with PCM/TM & RP/TM	Door Finish

Note: Furniture codes beginning with the letter 'R' are assembled (rigid), by removing the 'R' the units are supplied unassembled (flat-pack).





## Bedrooms.

It's time to wind down and get comfortable, relax into a peaceful slumber.

Our bedroom range ensures your private retreat is clutter free to set the perfect ambience. With our bedroom range, your private retreat is thoughtfully designed to maintain a clutter-free environment, ensuring the ideal ambience for your relaxation.

BEDROOMS

PRICE GROUP 7

# HOLTON

Colours Options: Anthracite, Blueberry, Fjord, Laurel, Lichen, Oyster, Monsoon, Stone, Storm Grey and White.



**ROBE CORNER ROBE ANGLED ROBE**

**ROBE** Standard Height Tall Height Standard Height Tall Height Standard Height Tall Height Standard Height

CODE	WIDTH	CODE	WIDTH	CODE	WIDTH	CODE	WIDTH	CODE	WIDTH	CODE	WIDTH	CODE	WIDTH
<b>SR30</b>	300	<b>TR30</b>	300	<b>SMR40</b>	400	<b>TMR40</b>	400	<b>SCR60</b>	600	<b>TCR60</b>	600	<b>SAR30</b>	300
<b>SR35</b>	350	<b>TR35</b>	350	<b>SMR45</b>	450	<b>TMR45</b>	450	<b>SCR80</b>	800	<b>TCR80</b>	800		
<b>SR40</b>	400	<b>TR40</b>	400	<b>SMR50</b>	500	<b>TMR50</b>	500	<b>SCR90</b>	900	<b>TCR90</b>	900	<b>SMAR30</b>	300
<b>SR45</b>	450	<b>TR45</b>	450	<b>SMR80</b>	800	<b>TMR80</b>	800	<b>SCR10</b>	1000	<b>TCR10</b>	1000		
<b>SR50</b>	500	<b>TR50</b>	500	<b>SMR90</b>	900	<b>TMR90</b>	900	Solid Door		Solid Door		Specify LH or RH	
<b>SR60*</b>	600	<b>TR60*</b>	600	<b>SMR10</b>	1000	<b>TMR10</b>	1000	<b>SMCR80*</b>	800	<b>TMCR80</b>	800	Supplied with four shelves	
<b>SR70</b>	700	<b>TR70</b>	700	Mirror Door		Mirror Door		<b>SMCR90*</b>	900	<b>TMCR90</b>	900		
<b>SR80</b>	800	<b>TR80</b>	800					<b>SMCR10*</b>	1000	<b>TMCR10</b>	1000		
<b>SR90</b>	900	<b>TR90</b>	900					Mirror Door		Mirror Door			
<b>SR10</b>	1000	<b>TR10</b>	1000										

H:2116mm CODE WIDTH H:2221mm CODE WIDTH H:2116mm CODE WIDTH H:2221mm CODE WIDTH H:2116mm CODE WIDTH H:2221mm CODE WIDTH H:2116mm CODE WIDTH H:2221mm CODE WIDTH

**SR10** Solid Door \*2 x Doors  
**TR10** Solid Door \*2 x Doors

**ANGLED ROBE STABLE ROBE DIAGONAL ROBE COMBINATION ROBE**

**ANGLED ROBE** Tall Height **STABLE ROBE** Standard Height Tall Height **DIAGONAL ROBE** Standard Height Tall Height **COMBINATION ROBE** Standard Height Tall Height

CODE	WIDTH	CODE	WIDTH	CODE	WIDTH	CODE	WIDTH	CODE	WIDTH	CODE	WIDTH
<b>TAR30</b>	300	<b>SSR50</b>	500	<b>TSR50</b>	500	<b>SDR970</b>	970/970	<b>TDR970</b>	970/970	<b>SCBR240</b>	400
Solid Door		<b>SSR10</b>	1000	<b>TSR10</b>	1000	Solid Door		<b>TDR10</b>	Solid Door	<b>TCBR245</b>	450
<b>TMAR30</b>	300	Specify LH or RH		Specify LH or RH		<b>SMDR970</b>	970/970	<b>TMDR970</b>	970/970	<b>TCBR250</b>	500
Mirror Door		RH Shown		RH Shown		<b>SCBR280</b>	800	<b>TMDR280</b>	800	<b>TCBR280</b>	800
Specify LH or RH						<b>SCBR290</b>	900	<b>TMDR290</b>	900	<b>TCBR290</b>	900
Supplied with four shelves						<b>SCBR210</b>	1000	<b>TMDR210</b>	1000	<b>TCBR210</b>	1000
						Two Drawers [2x355]		Two Drawers [2x355]		Two Drawers [2x355]	

H:2221mm CODE WIDTH H:2116mm CODE WIDTH H:2221mm CODE WIDTH H:2116mm CODE WIDTH H:2221mm CODE WIDTH H:2116mm CODE WIDTH H:2221mm CODE WIDTH

**COMBINATION ROBE TALL BOY CHEST**

**COMBINATION ROBE** Standard Height Tall Height Standard Height Tall Height **TALL BOY CHEST** 3 Drawers 4 Drawers 6 Drawers

CODE	WIDTH	CODE	WIDTH	CODE	WIDTH	CODE	WIDTH	CODE	WIDTH	CODE	WIDTH
<b>SCBR340</b>	400	<b>TCBR340</b>	400	<b>SCBR440</b>	400	<b>TCBR440</b>	400	<b>TBDC360</b>	600	<b>TBDC460</b>	600
<b>SCBR345</b>	450	<b>TCBR345</b>	450	<b>SCBR445</b>	450	<b>TCBR445</b>	450	<b>TBDC380</b>	800	<b>TBDC480</b>	800
<b>SCBR350</b>	500	<b>TCBR350</b>	500	<b>SCBR450</b>	500	<b>TCBR450</b>	500	Three Drawers [3x355]		Four Drawers [2x175 & 2x355]	
<b>SCBR380</b>	800	<b>TCBR380</b>	800	<b>SCBR480</b>	800	<b>TCBR480</b>	800			Six Drawers [6x175]	
<b>SCBR390</b>	900	<b>TCBR390</b>	900	<b>SCBR490</b>	900	<b>TCBR490</b>	900				
<b>SCBR310</b>	1000	<b>TCBR310</b>	1000	<b>SCBR410</b>	1000	<b>TCBR410</b>	1000				
Three Drawers [2x175 & 1x355]		Three Drawers [2x175 & 1x355]		Four Drawers [4x175]		Four Drawers [4x175]					

H:2116mm CODE WIDTH H:2221mm CODE WIDTH H:2116mm CODE WIDTH H:2221mm CODE WIDTH H:1137mm CODE WIDTH H:1137mm CODE WIDTH H:1137mm CODE WIDTH

**BRIDGING UNIT STANDARD CABINET DRAWLINE CABINET CORNER CABINET DRAWER CHEST**

**BRIDGING UNIT** Scribing Panel **STANDARD CABINET** **DRAWLINE CABINET** **CORNER CABINET** **DRAWER CHEST** Standard 2 Drawer 3 Drawer

CODE	WIDTH	CODE	WIDTH	CODE	WIDTH	CODE	WIDTH	CODE	WIDTH	CODE	WIDTH
<b>BU40</b>	400	<b>BP2400/655/OH</b>	655	<b>SC30</b>	300	<b>SDC30</b>	300	<b>SCC60</b>	600	<b>SDC230</b>	300
<b>BU45</b>	450	Fit to the underside of bridging units to match plant-on end panels		<b>SC35</b>	350	<b>SDC35</b>	350	<b>SCC80</b>	800	<b>SDC235</b>	350
<b>BU50</b>	500	Painted		<b>SC40</b>	400	<b>SDC40</b>	400	Excludes chest top		<b>SDC240</b>	400
<b>BU80</b>	800			<b>SC45</b>	450	<b>SDC45</b>	450			<b>SDC245</b>	450
<b>BU90</b>	900			<b>SC50</b>	500	<b>SDC50</b>	500			<b>SDC250</b>	500
<b>BU10</b>	1000			<b>SC60</b>	600	<b>SDC60</b>	600			<b>SDC260</b>	600
				<b>SC80</b>	800	<b>SDC80</b>	800			<b>SDC280</b>	800
				Excludes chest top		Excludes chest top				Excludes chest top	
										Two drawers [2x355]	
										Three drawers [2x175 & 1x355]	

H:459mm CODE WIDTH H:2400mm CODE WIDTH H:778mm CODE WIDTH H:778mm CODE WIDTH H:778mm CODE WIDTH H:778mm CODE WIDTH H:778mm CODE WIDTH

**DRAWER CHEST BEDSIDE CABINET BEDSIDE DRAWER CHEST 3 Drawer FLOATING DRAWER WINDOW SEAT 1 Drawer 2 Drawer**

**DRAWER CHEST** 4 Drawer **BEDSIDE CABINET** **BEDSIDE DRAWER CHEST** 2 Drawer 3 Drawer **FLOATING DRAWER** **WINDOW SEAT** 1 Drawer 2 Drawer

CODE	WIDTH	CODE	WIDTH	CODE	WIDTH	CODE	WIDTH	CODE	WIDTH	CODE	WIDTH
<b>SDC430</b>	300	<b>BSC20</b>	200	<b>BSD230</b>	300	<b>BSD330</b>	300	<b>FBSD40</b>	400	<b>WDS160</b>	600
<b>SDC435</b>	350	<b>BSC30</b>	300	<b>BSD235</b>	350	<b>BSD335</b>	350	<b>FBSD50</b>	500	<b>WDS180</b>	800
<b>SDC440</b>	400	<b>BSC35</b>	350	<b>BSD240</b>	400	<b>BSD340</b>	400	<b>FBSD60</b>	600	Excludes chest top	
<b>SDC445</b>	450	<b>BSC40</b>	400	<b>BSD245</b>	450	<b>BSD345</b>	450	One drawer [1x355]		One drawer [1x355]	
<b>SDC450</b>	500	<b>BSC45</b>	450	<b>BSD250</b>	500	<b>BSD350</b>	500			Two Drawers [2x175]	
<b>SDC460</b>	600	<b>BSC50</b>	500	<b>BSD260</b>	600	<b>BSD360</b>	600				
<b>SDC480</b>	800	<b>BSC60</b>	600	<b>BSD280</b>	800	<b>BSD380</b>	800				
Excludes chest top		<b>BSC80</b>	800	Excludes chest top		Excludes chest top					
Four drawers [4x175]		Excludes chest top		Two drawers [1x175 & 1x355]		Three drawers [3x175]					

H:778mm CODE WIDTH H:598mm CODE WIDTH H:598mm CODE WIDTH H:598mm CODE WIDTH H:359mm CODE WIDTH H:418mm CODE WIDTH H:418mm CODE WIDTH

**DRESSING TABLE DRAWER CHEST TOPS INTERIOR ROBE INTERNAL DIVIDERS**

**DRESSING TABLE DRAWER** Single Drawer **CHEST TOPS** 18mm Painted **INTERIOR ROBE** 4 Drawer Chest **INTERNAL DIVIDERS** Standard Height Tall Height

Single overhang = one plant-on end panel  
Double overhang = two plant-on end panels

CODE	WIDTH	CODE	WIDTH	CODE	WIDTH	CODE	WIDTH	CODE	WIDTH	CODE	WIDTH
<b>DTD60</b>	600	<b>WT200SO</b>	228	<b>WT400DO</b>	456	<b>WT800SO</b>	828	<b>INT4DR40</b>	400	<b>ISRD60</b>	600
<b>DTD70</b>	700	Suits 200 base with Single overhang		Suits 400 base with Double overhang		Suits 800 base with Single overhang		<b>INT4DR50</b>	500	<b>ISRD70</b>	700
<b>DTD80</b>	800	<b>WT200DO</b>	256	<b>WT450SO</b>	478	<b>WT800DO</b>	856	<b>INT4DR60</b>	600	<b>ISRD80</b>	800
Excludes chest top		Suits 200 base with Double overhang		Suits 450 base with Single overhang		Suits 800 base with Double overhang		<b>INT4DR70</b>	700	<b>ISRD90</b>	900
One drawer [1x175]		<b>WT300SO</b>	328	<b>WT450DO</b>	506	<b>WT1200SO</b>	1228	<b>INT4DR80</b>	800	<b>ISRD10</b>	1000
		Suits 300 base with Single overhang		Suits 450 base with Double overhang		Suits 1200 base with Single overhang		<b>INT4DR90</b>	900	Consists:	
		<b>WT300DO</b>	356	<b>WT500SO</b>	528	<b>WT1200DO</b>	1256	<b>INT4DR10</b>	1000	1 x Vertical Divide & 3 Shelves	
		Suits 300 base with Double overhang		Suits 500 base with Single overhang		Suits 1200 base with Double overhang		Top included		1 x Vertical Divide & 3 Shelves	
		<b>WT350SO</b>	378	<b>WT500DO</b>	556	<b>WT1600SO</b>	1628				
		Suits 350 base with Single overhang		Suits 500 base with Double overhang		Suits 1600 base with Single overhang					
		<b>WT350DO</b>	406	<b>WT600SO</b>	628	<b>WT1600DO</b>	1656				
		Suits 350 base with Double overhang		Suits 600 base with Single overhang		Suits 1600 base with Double overhang					
		<b>WT400SO</b>	428	<b>WT600DO</b>	656	<b>WT2400</b>	2400				
		Suits 400 base with Single overhang		Suits 600 base with Double overhang							

H:180mm CODE WIDTH D:520mm CODE WIDTH CODE WIDTH H:735mm CODE WIDTH

**INTERNAL HANGING RAILS - SPARE INTERNAL SHELVES - SPARE MODERN CORNICE PLINTH INTERIOR MIRROR**

**INTERNAL HANGING RAILS - SPARE** **INTERNAL SHELVES - SPARE** **MODERN CORNICE** **PLINTH** **INTERIOR MIRROR**

CODE	WIDTH	CODE	WIDTH	CODE	WIDTH	CODE	LENGTH	CODE	HEIGHT	CODE	WIDTH
<b>HR300</b>	300	<b>HR700</b>	700	<b>RS300</b>	300	<b>RS700</b>	700	<b>BCM/OH*</b>	3000	<b>BPL60/OH*</b>	60
<b>HR350</b>	350	<b>HR800</b>	800	<b>RS350</b>	350	<b>RS800</b>	800	Painted		<b>BPL100/OH*</b>	100
<b>HR400</b>	400	<b>HR900</b>	900	<b>RS400</b>	400	<b>RS900</b>	900			Scribe to suit on site	
<b>HR450</b>	450	<b>HR1000</b>	1000	<b>RS450</b>	450	<b>RS1000</b>	1000			Painted	
<b>HR500</b>	500	<b>HRD*</b>		<b>RS500</b>	500	<b>RSDIAG*</b>					
<b>HR600</b>	600	*Diagonal Robe		<b>RS600</b>	600	*Diagonal Robe					

H:49mm CODE LENGTH L:3000mm CODE HEIGHT H:1550mm CODE WIDTH

**PLANT ON END PANELS EDGING TAPE**

**PLANT ON END PANELS** 18mm Painted **EDGING TAPE**

CODE	WIDTH	CODE	WIDTH
<b>BP1200/520/OH</b>	520x1200	<b>10ET/OGT</b>	10mtr
Tall Boy		Carcase edging / Un-glued	
<b>BP2400/655/OH</b>	655x2400	<b>3ET/OH</b>	3mtr
Robe		Painted / Pre-glued	
<b>BP2800/170/OH</b>	170x2800		
Flat pelmet/filler			
<b>BP459/665/OH</b>	665x459		
Bridging unit			
<b>BP856/520/OH</b>	520x856		
Base cabinet			

H:22mm CODE WIDTH



**BEDROOMS**  
**PRICE GROUP 1**  
**LUCCO**

Colours Options: Anthracite, Grey Oak, Light Oak and Walnut.



**ROBE**      **CORNER ROBE**      **ANGLED ROBE**

Standard Height		Tall Height		Standard Height		Tall Height		Standard Height		Tall Height		Standard Height			
CODE	WIDTH	CODE	WIDTH	CODE	WIDTH	CODE	WIDTH	CODE	WIDTH	CODE	WIDTH	CODE	WIDTH		
SR30	300	TR30	300	SMR40	400	TMR40	400	SCR60	600	TCR60	600	SAR30	300		
SR35	350	TR35	350	SMR45	450	TMR45	450	SCR80	800	TCR80	800				
SR40	400	TR40	400	SMR50	500	TMR50	500	SCR90	900	TCR90	900				
SR45	450	TR45	450	SMR80	800	TMR80	800	SCR10	1000	TCR10	1000				
SR50	500	TR50	500	SMR90	900	TMR90	900								
SR60*	600	TR60*	600	SMR10	1000	TMR10	1000	SMCR80*	800	TMCR80	800				
SR70	700	TR70	700					SMCR90*	900	TMCR90	900				
SR80	800	TR80	800					SMCR10*	1000	TMCR10	1000				
SR90	900	TR90	900												
SR10	1000	TR10	1000												

Notes: SR60, TR60, SMR10, TMR10, SMCR80\*, SMCR90\*, SMCR10\* are Mirror Door. SR10, TR10 are Solid Door. \*2 x Doors. TMR90, TMR10 are Mirror Door. TMCR80, TMCR90, TMCR10 are Solid Door. SAR30, SMAR30 are Mirror Door. Specify LH or RH. Supplied with four shelves.

**ANGLED ROBE**      **STABLE ROBE**      **DIAGONAL ROBE**      **COMBINATION ROBE**

Tall Height		Standard Height		Tall Height		Standard Height		Tall Height		Standard Height		Tall Height			
CODE	WIDTH	CODE	WIDTH	CODE	WIDTH	CODE	WIDTH	CODE	WIDTH	CODE	WIDTH	CODE	WIDTH		
TAR30	300	SSR50	500	TSR50	500	SDR970	970/970	TDR970	970/970	SCBR240	400	TCBR240	400		
TAR30	300	SSR10	1000	TSR10	1000	SDR970	970/970	TDR970	970/970	SCBR245	450	TCBR245	450		
						SMDR970	970/970	TMDR970	970/970	SCBR250	500	TCBR250	500		
										SCBR280	800	TCBR280	800		
										SCBR290	900	TCBR290	900		
										SCBR210	1000	TCBR210	1000		

Notes: TAR30, TMDR970 are Mirror Door. Specify LH or RH. Supplied with four shelves. SSR50, SSR10, TSR50, TSR10 are Solid Door. RH Shown. SMDR970, TMDR970 are Mirror Door. SCBR240, TCBR240, SCBR245, TCBR245, SCBR250, TCBR250, SCBR280, TCBR280, SCBR290, TCBR290, SCBR210, TCBR210 are Two Drawers [2x355].

**COMBINATION ROBE**      **TALL BOY CHEST**

Standard Height		Tall Height		Standard Height		Tall Height		3 Drawers		4 Drawers		6 Drawers			
CODE	WIDTH	CODE	WIDTH	CODE	WIDTH	CODE	WIDTH	CODE	WIDTH	CODE	WIDTH	CODE	WIDTH		
SCBR340	400	TCBR340	400	SCBR440	400	TCBR440	400	TBDC360	600	TBDC460	600	TBDC660	600		
SCBR345	450	TCBR345	450	SCBR445	450	TCBR445	450	TBDC380	800	TBDC480	800	TBDC680	800		
SCBR350	500	TCBR350	500	SCBR450	500	TCBR450	500								
SCBR380	800	TCBR380	800	SCBR480	800	TCBR480	800								
SCBR390	900	TCBR390	900	SCBR490	900	TCBR490	900								
SCBR310	1000	TCBR310	1000	SCBR410	1000	TCBR410	1000								

Notes: SCBR340, TCBR340, SCBR345, TCBR345, SCBR350, TCBR350, SCBR380, TCBR380, SCBR390, TCBR390, SCBR310, TCBR310 are Three Drawers [2x175 & 1x355]. SCBR440, TCBR440, SCBR445, TCBR445, SCBR450, TCBR450, SCBR480, TCBR480, SCBR490, TCBR490, SCBR410, TCBR410 are Four Drawers [4x175]. TBDC360, TBDC380, TBDC460, TBDC480, TBDC660, TBDC680 are Three Drawers [3x355]. TBDC460, TBDC480, TBDC660, TBDC680 are Four Drawers [2x175 & 2x355]. TBDC660, TBDC680 are Six Drawers [6x175].

**BRIDGING UNIT**      **STANDARD CABINET**      **DRAWLINE CABINET**      **CORNER CABINET**      **DRAWER CHEST**

Scribing Panel		Standard		2 Drawer		3 Drawer			
CODE	WIDTH	CODE	WIDTH	CODE	WIDTH	CODE	WIDTH		
BU40	400	BP2400/655/O	655	SC30	300	SDC30	300	SDC330	300
BU45	450			SC35	350	SDC35	350	SDC335	350
BU50	500			SC40	400	SDC40	400	SDC340	400
BU80	800			SC45	450	SDC45	450	SDC345	450
BU90	900			SC50	500	SDC50	500	SDC350	500
BU10	1000			SC60	600	SDC60	600	SDC360	600
				SC80	800	SDC80	800	SDC380	800

Notes: BU40, BU45, BU50, BU80, BU90, BU10 are Bridging unit. BP2400/655/O is Bridging unit. SC30, SC35, SC40, SC45, SC50, SC60, SC80 are Standard. SD C30, SD C35, SD C40, SD C45, SD C50, SD C60, SD C80 are Two Drawers [2x355]. SD C330, SD C335, SD C340, SD C345, SD C350, SD C360, SD C380 are Three Drawers [2x175 & 1x355].

**DRAWER CHEST**      **BEDSIDE CABINET**      **BEDSIDE DRAWER CHEST**      **FLOATING DRAWER**      **WINDOW SEAT**

4 Drawer		2 Drawer		3 Drawer		1 Drawer		2 Drawer			
CODE	WIDTH	CODE	WIDTH	CODE	WIDTH	CODE	WIDTH	CODE	WIDTH		
SDC430	300	BSD230	300	BSD330	300	FBSD40	400	WDS160	600	WDS260	600
SDC435	350	BSD235	350	BSD335	350	FBSD50	500	WDS180	800	WDS280	800
SDC440	400	BSD240	400	BSD340	400	FBSD60	600				
SDC445	450	BSD245	450	BSD345	450						
SDC450	500	BSD250	500	BSD350	500						
SDC460	600	BSD260	600	BSD360	600						
SDC480	800	BSD280	800	BSD380	800						

Notes: SDC430, SDC435, SDC440, SDC445, SDC450, SDC460, SDC480 are Four drawers [4x175]. BSD230, BSD235, BSD240, BSD245, BSD250, BSD260, BSD280 are Two drawers [1x175 & 1x355]. BSD330, BSD335, BSD340, BSD345, BSD350, BSD360, BSD380 are Three Drawers [3x175]. FBSD40, FBSD50, FBSD60 are One drawer [1x355]. WDS160, WDS180, WDS260, WDS280 are Excludes chest top. WDS180 is One drawer [1x355]. WDS260, WDS280 are Two Drawers [2x175].

**DRESSING TABLE DRAWER**      **CHEST TOPS**      **INTERIOR ROBE**      **INTERNAL DIVIDERS**

Single Drawer		18mm MFC		4 Drawer Chest		Standard Height		Tall Height			
CODE	WIDTH	CODE	WIDTH	CODE	WIDTH	CODE	WIDTH	CODE	WIDTH		
DTD60	600	WT200SO	228	WT400DO	456	WT800SO	828	INT4DR40	400	ISRD60	600
DTD70	700	WT200DO	256	WT450SO	478	WT800DO	856	INT4DR50	500	ISRD70	700
DTD80	800	WT300SO	328	WT450DO	506	WT1200SO	1228	INT4DR60	600	ISRD80	800
		WT300DO	356	WT500SO	528	WT1200DO	1256	INT4DR70	700	ISRD90	900
		WT350SO	378	WT500DO	556	WT1600SO	1628	INT4DR80	800	ISRD10	1000
		WT350DO	406	WT600SO	628	WT1600DO	1656	INT4DR90	900		
		WT400SO	428	WT600DO	656	WT2400	2400	INT4DR10	1000		

Notes: DTD60, DTD70, DTD80 are Excludes chest top. One drawer [1x175]. WT200SO, WT200DO, WT300SO, WT300DO, WT350SO, WT350DO, WT400SO, WT400DO, WT450SO, WT450DO, WT500SO, WT500DO, WT600SO, WT600DO, WT800SO, WT800DO, WT1200SO, WT1200DO, WT1600SO, WT1600DO, WT2400 are Suits 200 base with Single overhang, Suits 400 base with Double overhang, Suits 450 base with Single overhang, Suits 450 base with Double overhang, Suits 500 base with Single overhang, Suits 500 base with Double overhang, Suits 500 base with Single overhang, Suits 500 base with Double overhang, Suits 550 base with Single overhang, Suits 550 base with Double overhang, Suits 600 base with Single overhang, Suits 600 base with Double overhang, Suits 800 base with Single overhang, Suits 800 base with Double overhang, Suits 1200 base with Single overhang, Suits 1200 base with Double overhang, Suits 1600 base with Single overhang, Suits 1600 base with Double overhang, Suits 1600 base with Single overhang, Suits 1600 base with Double overhang. Int4DR40, Int4DR50, Int4DR60, Int4DR70, Int4DR80, Int4DR90, Int4DR10 are Top included. ISRD60, ISRD70, ISRD80, ISRD90, ISRD10 are Consists: 1 x Vertical Divide & 3 Shelves. ITRD60, ITRD70, ITRD80, ITRD90, ITRD10 are Consists: 1 x Vertical Divide & 3 Shelves.

**INTERNAL HANGING RAILS - SPARE**      **INTERNAL SHELVES - SPARE**      **FLAT CORNICE**      **PLINTH**      **INTERIOR MIRROR**

INTERNAL HANGING RAILS - SPARE		INTERNAL SHELVES - SPARE		FLAT CORNICE		PLINTH		INTERIOR MIRROR			
CODE	WIDTH	CODE	WIDTH	CODE	DEPTH	CODE	HEIGHT	CODE	WIDTH		
HR300	300	HR700	700	RS300	300	RS700	700	BCM/O*	60	BPL60/O*	60
HR350	350	HR800	800	RS350	350	RS800	800			BPL100/O*	100
HR400	400	HR900	900	RS400	400	RS900	900				
HR450	450	HR1000	1000	RS450	450	RS1000	1000				
HR500	500	HRD*		RS500	500	RSDIAG*					
HR600	600			RS600	600						

Notes: HRD\*, HR1000 are \*Diagonal Robe. RSDIAG\* is \*Diagonal Robe. BCM/O\* is MFC. BPL60/O\*, BPL100/O\* are Scribe to suit on site MFC. IRM is Supplied with fixings. Minimum door width 400.

**PLANT ON END PANELS**      **EDGING TAPE**

18mm MFC		H:22mm	
CODE	WIDTH	CODE	WIDTH
BP1200/520/O	520x1200	10ET/OGT	10mtr
BP2400/655/O	655x2400	10ET/O	10mtr
BP2800/170/O	170x2800		
BP459/665/O	665x459		
BP856/520/O	520x856		

Notes: BP1200/520/O, BP2400/655/O, BP2800/170/O, BP459/665/O, BP856/520/O are Tail Boy. 10ET/OGT, 10ET/O are Carcase edging / Un-glued. BP2800/170/O is Robe. BP459/665/O is Flat pelmet/filler. BP856/520/O is Bridging unit. Base cabinet.

BEDROOMS

PRICE GROUP 4

**NOTO**

Colours Options: Dust Grey, Grey, Oyster and White.



**ROBE CORNER ROBE ANGLED ROBE**

Standard Height		Tall Height		Standard Height		Tall Height		Standard Height		Tall Height		Standard Height	
H:2116mm	CODE	WIDTH	CODE	WIDTH	H:2221mm	CODE	WIDTH	H:2116mm	CODE	WIDTH	H:2221mm	CODE	WIDTH
SR30	TR30	300	SMR40	400	TMR40	400	SCR60	600	TCR60	600	SAR30	300	
SR35	TR35	350	SMR45	450	TMR45	450	SCR80	800	TCR80	800	SAR30	300	
SR40	TR40	400	SMR50	500	TMR50	500	SCR90	900	TCR90	900	SAR30	300	
SR45	TR45	450	SMR80	800	TMR80	800	SCR10	1000	TCR10	1000	SAR30	300	
SR50	TR50	500	SMR90	900	TMR90	900	SMCR80*	800	SMCR80*	800	SAR30	300	
SR60*	TR60*	600	SMR10	1000	TMR10	1000	SMCR90*	900	SMCR90*	900	SAR30	300	
SR70	TR70	700					SMCR10*	1000	SMCR10*	1000	SAR30	300	
SR80	TR80	800											
SR90	TR90	900											
SR10	TR10	1000											

**ANGLED ROBE STABLE ROBE DIAGONAL ROBE COMBINATION ROBE**

Tall Height		Standard Height		Tall Height		Standard Height		Tall Height		Standard Height		Tall Height	
H:2221mm	CODE	WIDTH	H:2116mm	CODE	WIDTH	H:2221mm	CODE	WIDTH	H:2116mm	CODE	WIDTH	H:2221mm	CODE
TAR30	SSR50	300	TSR50	500	SDR970	970/970	TDR970	970/970	SCBR240	400	TCBR240	400	
TAR30	SSR10	300	TSR10	1000	SMDR970	970/970	TMDR970	970/970	SCBR245	450	TCBR245	450	
TAR30	SSR10	300	TSR10	1000	SMDR970	970/970	TMDR970	970/970	SCBR250	500	TCBR250	500	
TAR30	SSR10	300	TSR10	1000	SMDR970	970/970	TMDR970	970/970	SCBR280	800	TCBR280	800	
TAR30	SSR10	300	TSR10	1000	SMDR970	970/970	TMDR970	970/970	SCBR290	900	TCBR290	900	
TAR30	SSR10	300	TSR10	1000	SMDR970	970/970	TMDR970	970/970	SCBR210	1000	TCBR210	1000	

**COMBINATION ROBE TALL BOY CHEST**

Standard Height		Tall Height		Standard Height		Tall Height		3 Drawers		4 Drawers		6 Drawers	
H:2116mm	CODE	WIDTH	H:2221mm	CODE	WIDTH	H:2116mm	CODE	WIDTH	H:1137mm	CODE	WIDTH	H:1137mm	CODE
SCBR340	TCBR340	400	SCBR440	400	TCBR440	400	TBDC360	600	TBDC460	600	TBDC660	600	
SCBR345	TCBR345	450	SCBR445	450	TCBR445	450	TBDC380	800	TBDC480	800	TBDC680	800	
SCBR350	TCBR350	500	SCBR450	500	TCBR450	500							
SCBR380	TCBR380	800	SCBR480	800	TCBR480	800							
SCBR390	TCBR390	900	SCBR490	900	TCBR490	900							
SCBR310	TCBR310	1000	SCBR410	1000	TCBR410	1000							

**BRIDGING UNIT STANDARD CABINET DRAWLINE CABINET CORNER CABINET DRAWER CHEST**

Scribing Panel		Standard		2 Drawer		3 Drawer	
H:459mm	CODE	WIDTH	H:778mm	CODE	WIDTH	H:778mm	CODE
BU40	SC30	400	SDC30	300	SDC30	300	SDC330
BU45	SC35	450	SDC35	350	SDC35	350	SDC335
BU50	SC40	500	SDC40	400	SDC40	400	SDC340
BU80	SC45	800	SDC45	450	SDC45	450	SDC345
BU90	SC50	900	SDC50	500	SDC50	500	SDC350
BU10	SC60	1000	SDC60	600	SDC60	600	SDC360
			SC80	800	SDC80	800	SDC380

DRAWER CHEST		BEDSIDE CABINET		BEDSIDE DRAWER CHEST		FLOATING DRAWER		WINDOW SEAT	
4 Drawer	H:778mm	CODE	WIDTH	2 Drawer	H:598mm	CODE	WIDTH	1 Drawer	H:418mm
SDC430	300	BSC20	200	BSD230	300	BSD330	300	WDS160	600
SDC435	350	BSC30	300	BSD235	350	BSD335	350	WDS180	800
SDC440	400	BSC35	350	BSD240	400	BSD340	400	Excludes chest top	
SDC445	450	BSC40	400	BSD245	450	BSD345	450	One drawer [1x355]	
SDC450	500	BSC45	450	BSD250	500	BSD350	500		
SDC460	600	BSC50	500	BSD260	600	BSD360	600		
SDC480	800	BSC60	600	BSD280	800	BSD380	800		
Excludes chest top		BSC80	800	Excludes chest top		Excludes chest top			
Four drawers [4x175]				Two drawers [1x175 & 1x355]		Three drawers [3x175]			

DRESSING TABLE DRAWER		CHEST TOPS		INTERIOR ROBE		INTERNAL DIVIDERS	
Single Drawer	H:180mm	18mm Foil	D:520mm	4 Drawer Chest	H:735mm	Standard Height	Tall Height
WT2000	600	WT2000S	228	INT4DR40	400	ISRD60	600
WT2000	700	Suits 200 base with Single overhang		INT4DR50	500	ISRD70	700
WT2000	800	Suits 400 base with Double overhang		INT4DR60	600	ISRD80	800
Excludes chest top		Suits 200 base with Double overhang		INT4DR70	700	ISRD90	900
One drawer [1x175]		Suits 450 base with Single overhang		INT4DR80	800	ISRD100	1000
		Suits 300 base with Single overhang		INT4DR90	900	Consists:	
		Suits 300 base with Double overhang		INT4DR10	1000	1 x Vertical Divide & 3 Shelves	
		Suits 500 base with Single overhang		Top included		1 x Vertical Divide & 3 Shelves	
		Suits 500 base with Double overhang					
		Suits 350 base with Single overhang					
		Suits 350 base with Double overhang					
		Suits 400 base with Single overhang					
		Suits 600 base with Double overhang					

INTERNAL HANGING RAILS - SPARE		INTERNAL SHELVES - SPARE		MODERN CORNICE		PLINTH		INTERIOR MIRROR	
HR300	300	HR700	700	RS300	3000	BCM/O*	3000	H:1550mm	IRM
HR350	350	HR800	800	RS350	3500			CODE	WIDTH
HR400	400	HR900	900	RS400	4000			BPL60/O*	60
HR450	450	HR1000	1000	RS450	4500			BPL100/O*	100
HR500	500	HRD*		RS500	5000			Scribe to suit on site	
HR600	600	*Diagonal Robe		RS600	6000			Foil	
								Minimum door width 400	

PLANT ON END PANELS		EDGING TAPE	
18mm MFC	H:22mm	10ET/OGT	10mtr
BP1200/520/O	520x1200	Carcase edging / Un-glued	
BP2400/655/O	655x2400	10ET/O	10mtr
BP2800/170/O	170x2800	Plant-on panel/ chest top edging / Pre-glued	
BP459/665/O	665x459		
BP856/520/O	520x856		
Base cabinet			



BEDROOMS  
PRICE GROUP 2  
**SASSARI**

Colours Options: Cashmere, Dust Grey, Grey, Oyster and White.



**ROBE**      **CORNER ROBE**      **ANGLED ROBE**

Standard Height		Tall Height		Standard Height		Tall Height		Standard Height		Tall Height		Standard Height	
H:2116mm	CODE	WIDTH	CODE	WIDTH	H:2221mm	CODE	WIDTH	H:2116mm	CODE	WIDTH	H:2221mm	CODE	WIDTH
SR30	TR30	300	SMR40	400	TMR40	400	SCR60	600	TCR60	600	SAR30	300	
SR35	TR35	350	SMR45	450	TMR45	450	SCR80	800	TCR80	800	SAR30	300	
SR40	TR40	400	SMR50	500	TMR50	500	SCR90	900	TCR90	900	SAR30	300	
SR45	TR45	450	SMR80	800	TMR80	800	SCR10	1000	TCR10	1000	SAR30	300	
SR50	TR50	500	SMR90	900	TMR90	900	SMCR80*	800	SMCR80*	800	SAR30	300	
SR60*	TR60*	600	SMR10	1000	TMR10	1000	SMCR90*	900	SMCR90*	900	SAR30	300	
SR70	TR70	700					SMCR10*	1000	SMCR10*	1000	SAR30	300	
SR80	TR80	800											
SR90	TR90	900											
SR10	TR10	1000											

**ANGLED ROBE**      **STABLE ROBE**      **DIAGONAL ROBE**      **COMBINATION ROBE**

Tall Height		Standard Height		Tall Height		Standard Height		Tall Height		Standard Height		Tall Height	
H:2221mm	CODE	WIDTH	H:2116mm	CODE	WIDTH	H:2221mm	CODE	WIDTH	H:2116mm	CODE	WIDTH	H:2221mm	CODE
TAR30	SSR50	300	TSR50	500	SDR970	970/970	TDR970	970/970	SCBR240	400	TCBR240	400	
TAR30	SSR10	300	TSR10	1000	SMDR970	970/970	TMDR970	970/970	SCBR245	450	TCBR245	450	
TAR30	SSR10	300	TSR10	1000	SMDR970	970/970	TMDR970	970/970	SCBR250	500	TCBR250	500	
TAR30	SSR10	300	TSR10	1000	SMDR970	970/970	TMDR970	970/970	SCBR280	800	TCBR280	800	
TAR30	SSR10	300	TSR10	1000	SMDR970	970/970	TMDR970	970/970	SCBR290	900	TCBR290	900	
TAR30	SSR10	300	TSR10	1000	SMDR970	970/970	TMDR970	970/970	SCBR210	1000	TCBR210	1000	

**COMBINATION ROBE**      **TALL BOY CHEST**

Standard Height		Tall Height		Standard Height		Tall Height		3 Drawers		4 Drawers		6 Drawers	
H:2116mm	CODE	WIDTH	H:2221mm	CODE	WIDTH	H:2116mm	CODE	WIDTH	H:1137mm	CODE	WIDTH	H:1137mm	CODE
SCBR340	TCBR340	400	SCBR440	400	TCBR440	400	TBDC360	600	TBDC460	600	TBDC660	600	
SCBR345	TCBR345	450	SCBR445	450	TCBR445	450	TBDC380	800	TBDC480	800	TBDC680	800	
SCBR350	TCBR350	500	SCBR450	500	TCBR450	500							
SCBR380	TCBR380	800	SCBR480	800	TCBR480	800							
SCBR390	TCBR390	900	SCBR490	900	TCBR490	900							
SCBR310	TCBR310	1000	SCBR410	1000	TCBR410	1000							

**BRIDGING UNIT**      **STANDARD CABINET**      **DRAWLINE CABINET**      **CORNER CABINET**      **DRAWER CHEST**

Scribing Panel		Standard		2 Drawer		3 Drawer	
H:459mm	CODE	WIDTH	H:778mm	CODE	WIDTH	H:778mm	CODE
BU40	SC30	400	SDC30	SCC60	600	SDC230	300
BU45	SC35	450	SDC35	SCC80	800	SDC235	350
BU50	SC40	500	SDC40			SDC240	400
BU80	SC45	800	SDC45			SDC245	450
BU90	SC50	900	SDC50			SDC250	500
BU10	SC60	1000	SDC60			SDC260	600
			SDC80			SDC280	800

**DRAWER CHEST**      **BEDSIDE CABINET**      **BEDSIDE DRAWER CHEST**      **FLOATING DRAWER**      **WINDOW SEAT**

4 Drawer		2 Drawer		3 Drawer		1 Drawer		2 Drawer			
H:778mm	CODE	WIDTH	H:598mm	CODE	WIDTH	H:598mm	CODE	WIDTH	H:418mm	CODE	WIDTH
SDC430	BSC20	300	BSD230	BSD330	300	FBSD40	400	WDS160	600	WDS260	600
SDC435	BSC30	350	BSD235	BSD335	350	FBSD50	500	WDS180	800	WDS280	800
SDC440	BSC35	400	BSD240	BSD340	400	FBSD60	600				
SDC445	BSC40	450	BSD245	BSD345	450						
SDC450	BSC45	500	BSD250	BSD350	500						
SDC460	BSC50	600	BSD260	BSD360	600						
SDC480	BSC60	800	BSD280	BSD380	800						

**DRESSING TABLE DRAWER**      **CHEST TOPS**      **INTERIOR ROBE**      **INTERNAL DIVIDERS**

Single Drawer		18mm Foil		4 Drawer Chest		Standard Height		Tall Height		
H:180mm	CODE	WIDTH	D:520mm	CODE	WIDTH	H:735mm	CODE	WIDTH	CODE	WIDTH
DTD60	WT200S0	600	WT400D0	WT800S0	828	INT4DR40	ISRD60	600	ITRD60	600
DTD70	WT200D0	700	WT450S0	WT800D0	856	INT4DR50	ISRD70	700	ITRD70	700
DTD80	WT300S0	800	WT500S0	WT1200S0	1228	INT4DR60	ISRD80	800	ITRD80	800
	WT300D0	328	WT500D0	WT1200D0	1256	INT4DR70	ISRD90	900	ITRD90	900
	WT350S0	356	WT550S0	WT1600S0	1628	INT4DR80	ISRD100	1000	ITRD100	1000
	WT350D0	378	WT600S0	WT1600D0	1656	INT4DR90				
	WT350D0	406	WT600D0	WT2400	2400	INT4DR100				
	WT400S0	428								

**INTERNAL HANGING RAILS - SPARE**      **INTERNAL SHELVES - SPARE**      **MODERN CORNICE**      **PLINTH**      **INTERIOR MIRROR**

INTERNAL HANGING RAILS - SPARE		INTERNAL SHELVES - SPARE		MODERN CORNICE		PLINTH		INTERIOR MIRROR	
CODE	WIDTH	CODE	WIDTH	CODE	LENGTH	CODE	HEIGHT	CODE	WIDTH
HR300	300	HR700	700	RS300	3000	BPL60/O*	60	IRM	300
HR350	350	HR800	800	RS350	3500	BPL100/O*	100		
HR400	400	HR900	900	RS400	4000				
HR450	450	HR1000	1000	RS450	4500				
HR500	500	HRD*		RS500	5000				
HR600	600			RS600	6000				

**PLANT ON END PANELS**      **EDGING TAPE**

18mm MFC		H:22mm	
CODE	WIDTH	CODE	WIDTH
BP1200/520/O	520x1200	10ET/OGT	10mtr
BP2400/655/O	655x2400	10ET/O	10mtr
BP2800/170/O	170x2800		
BP459/665/O	665x459		
BP856/520/O	520x856		

BEDROOMS

PRICE GROUP 3

SIENA

Colours Options: Grey, Oyster and White.



ROBE CORNER ROBE ANGLED ROBE

Table listing wardrobe options including Standard Height and Tall Height for Robe, Corner Robe, and Angled Robe. Includes codes like SR30, TR30, SMR40, TMR40, SCR60, TCR60, SAR30, etc.

ANGLED ROBE STABLE ROBE DIAGONAL ROBE COMBINATION ROBE

Table listing wardrobe options including Tall Height and Standard Height for Angled Robe, Stable Robe, Diagonal Robe, and Combination Robe. Includes codes like TAR30, SSR50, TSR50, SDR970, TDR970, SCBR240, etc.

COMBINATION ROBE TALL BOY CHEST

Table listing wardrobe options including Standard Height and Tall Height for Combination Robe, and 3, 4, and 6 Drawers for Tall Boy Chest. Includes codes like SCBR340, TCBR340, etc.

BRIDGING UNIT STANDARD CABINET DRAWLINE CABINET CORNER CABINET DRAWER CHEST

Table listing wardrobe options including Bridging Unit, Standard Cabinet, Drawline Cabinet, Corner Cabinet, and Drawer Chest. Includes codes like BU40, SC30, SCC60, SDC230, etc.

DRAWER CHEST BEDSIDE CABINET BEDSIDE DRAWER CHEST FLOATING DRAWER WINDOW SEAT

Table listing drawer chest and bedside cabinet options. Includes codes like SDC430, BSC20, BSD230, BSD330, FBSD40, WDS160, etc.

DRESSING TABLE DRAWER CHEST TOPS INTERIOR ROBE INTERNAL DIVIDERS

Table listing dressing table drawers, chest tops, interior robes, and internal dividers. Includes codes like WT200SO, WT450SO, WT800SO, etc.

INTERNAL HANGING RAILS - SPARE INTERNAL SHELVES - SPARE MODERN CORNICE PLINTH INTERIOR MIRROR

Table listing spare internal hanging rails, shelves, modern cornice, plinth, and interior mirrors. Includes codes like HR300, RS300, RS700, etc.

PLANT ON END PANELS EDGING TAPE

Table listing plant on end panels and edging tape. Includes codes like BP1200/520/O, 10ET/OGT, etc.





## Handles.

Will it be contemporary linear stainless steel, or a set of traditional pewter knobs? It's amazing how these small [and essential] items can completely transform the finish of your kitchen. Choose the handle that best fits the character of your kitchen, from professional-industrial to Victorian charm.

It's not simply about opening the doors - it's about completing the look.

# Bar Handles

Our collection of bar handles come in a variety of styles, sizes and colours, from traditional through to on-trend metallics to provide the perfect finishing touch and refinement to any kitchen.



MATT BLACK BOW HANDLE

CODE	WIDTH
H325	208



BRUSHED IRON D HANDLE

CODE	WIDTH
H365	204



ANTIQUÉ COPPER BOW HANDLE

CODE	WIDTH
H233	208



BRUSHED NICKEL D HANDLE

CODE	WIDTH
H366	204



BRUSHED IRON BOW HANDLE

CODE	WIDTH
H363	208



ANTIQUÉ COPPER D HANDLE

CODE	WIDTH
H367	204



BRUSHED NICKEL BOW HANDLE

CODE	WIDTH
H268	208



BRUSHED COPPER D HANDLE

CODE	WIDTH
H368	204



BRUSHED COPPER BOW HANDLE

CODE	WIDTH
H260	208



SATIN BRASS FLUTED BAR HANDLE

CODE	WIDTH
H369	264



ANTHRACITE KNURLED BAR HANDLE

CODE	WIDTH
H333	190



BRUSHED SATIN BRASS KNURLED BAR HANDLE

CODE	WIDTH
H290	200



BLACK KNURLED BAR HANDLE

CODE	WIDTH
H288	200



CHROME KNURLED BAR HANDLE

CODE	WIDTH
H289	200



MATT BLACK SLIM D HANDLE

CODE	WIDTH
H314	172



BRUSHED BRASS SLIM D HANDLE

CODE	WIDTH
H300	138



ANTIQUÉ COPPER D HANDLE

CODE	WIDTH
H348	188



BRUSHED NICKEL D HANDLE

CODE	WIDTH
H298	168



ANTIQUÉ COPPER D HANDLE

CODE	WIDTH
H297	168



# Bar Handles

Our collection of bar handles come in a variety of styles, sizes and colours, from traditional through to on-trend metallics to provide the perfect finishing touch and refinement to any kitchen.



SATIN BRASS FLAT BAR HANDLE

CODE	WIDTH
H345	214



MATT BLACK SLIM D HANDLE

CODE	WIDTH
H284	172



BRUSHED SATIN BRASS PULL HANDLE

CODE	WIDTH
H347	160



MATT BLACK BAR HANDLE

CODE	WIDTH
H343	170



MATT BLACK PULL HANDLE

CODE	WIDTH
H320	160



BLACK KNURLED BAR HANDLE AND BACKPLATE

CODE	WIDTH
H305	190



BRUSHED SATIN BRASS BAR HANDLE

CODE	WIDTH
H357	128



ANTIQUe BRASS KNURLED BAR HANDLE AND BACKPLATE

CODE	WIDTH
H304	190



CHROME BAR HANDLE

CODE	WIDTH
H359	128



CHROME PULL HANDLE

CODE	WIDTH
H321	214



SATIN NICKEL LINEAR HANDLE

CODE	WIDTH
H236	256



IRON SQUARE BAR HANDLE

CODE	WIDTH
H340	202
H341	234



STAINLESS STEEL LINEAR HANDLE

CODE	WIDTH
H186	188

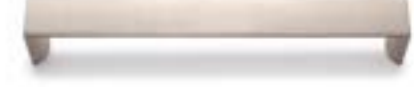

BRUSHED NICKEL CHUNKY D HANDLE

CODE	WIDTH
H200A	166



STAINLESS STEEL BAR HANDLE

CODE	WIDTH	CODE	WIDTH
H160	168	H163	488
H161	232		



FLAT CHROME BAR HANDLE

CODE	WIDTH
H338	206
H339	270



CHROME LINEAR HANDLE

CODE	WIDTH
H237	256



STAINLESS STEEL BOW SHAPED HANDLE

CODE	WIDTH
H181	180



STAINLESS STEEL EFFECT BAR HANDLE

CODE	WIDTH
H291	167



SATIN NICKEL STRAP HANDLE

CODE	WIDTH
H219	140



POLISHED CHROME ARC HANDLE

CODE	WIDTH
H251	200

# Knobs

Our range of kitchen knobs come in a variety of styles, button, flat, round, square and T-bar in a variety of colours and finishes and have accompanying bar handles to match.



BLACK KNURLED KNOB  
CODE WIDTH  
H309 35



CHROME FLAT KNOB  
CODE WIDTH  
H322 38



SATIN BRASS FLAT KNOB  
CODE WIDTH  
H344 38



BRUSHED SATIN BRASS KNOB + BACKPLATE  
CODE WIDTH  
H358 58



CHROME KNOB + BACKPLATE  
CODE WIDTH  
H360 58



BRUSHED COPPER FLAT KNOB  
CODE WIDTH  
H259 35



ANTIQUÉ COPPER FLAT KNOB  
CODE WIDTH  
H232 35



BRUSHED IRON FLAT KNOB  
CODE WIDTH  
H364 35



BRUSHED NICKEL FLAT KNOB  
CODE WIDTH  
H267 35



MATT BLACK FLAT KNOB  
CODE WIDTH  
H313 35



SATIN BRASS FLUTED KNOB  
CODE WIDTH  
H370 30



BRUSHED SATIN BRASS KNOB  
CODE WIDTH  
H354 35



ANTIQUÉ COPPER KNOB  
CODE WIDTH  
H353 35



BRUSHED NICKEL KNOB  
CODE WIDTH  
H355 35



BRUSHED IRON KNOB  
CODE WIDTH  
H356 35



BRUSHED SATIN BRASS BUTTON KNOB  
CODE WIDTH  
H283 38



BRUSHED COPPER BUTTON KNOB  
CODE WIDTH  
H263 38



ANTIQUÉ COPPER BUTTON KNOB  
CODE WIDTH  
H234 38



MATT BLACK BUTTON KNOB  
CODE WIDTH  
H312 38



GUNMETAL KNOB  
CODE WIDTH  
H337 38



BRUSHED SATIN BRASS KNURLED CYLINDER KNOB  
CODE WIDTH  
H287 30



BLACK KNURLED CYLINDER KNOB  
CODE WIDTH  
H285 30



CHROME KNURLED CYLINDER KNOB  
CODE WIDTH  
H286 30



BRUSHED SATIN BRASS 'T' BAR KNOB  
CODE WIDTH  
H346 56



MATT BLACK 'T' BAR KNOB  
CODE WIDTH  
H319 56



IRON EFFECT BUTTON KNOB  
CODE WIDTH  
H362 38



PEWTER EFFECT KNOB  
CODE WIDTH  
H180 33



POLISHED NICKEL KNOB  
CODE WIDTH  
H248 32



BRUSHED NICKEL BUTTON KNOB  
CODE WIDTH  
H269 38



CHROME BUTTON KNOB  
CODE WIDTH  
H250A 38



CHROME BUTTON KNOB  
CODE WIDTH  
H216 31



SATIN BRASS KNOB  
CODE WIDTH  
H293 60



ANTIQUÉ COPPER KNOB  
CODE WIDTH  
H294 60



BRUSHED NICKEL KNOB  
CODE WIDTH  
H295 60



STAINLESS STEEL EFFECT 'T' BAR KNOB  
CODE WIDTH  
H247 60



ANTIQUÉ KNURLED 'T' BAR KNOB  
CODE WIDTH  
H334 50



ANTIQUÉ BRASS KNURLED KNOB  
CODE WIDTH  
H342 35



SATIN BRASS KNURLED KNOB  
CODE WIDTH  
H327 30



BLACK KNURLED KNOB  
CODE WIDTH  
H326 30



CHROME KNURLED KNOB  
CODE WIDTH  
H328 30



ANTHRACITE KNURLED KNOB  
CODE WIDTH  
H335 35



SATIN BRASS KNURLED 'T' BAR KNOB  
CODE WIDTH  
H331 50



BLACK KNURLED 'T' BAR KNOB  
CODE WIDTH  
H330 50



CHROME KNURLED 'T' BAR KNOB  
CODE WIDTH  
H332 50



ANTIQUÉ BRASS KNURLED 'T' BAR KNOB  
CODE WIDTH  
H306 54



BLACK KNURLED 'T' BAR KNOB  
CODE WIDTH  
H307 54

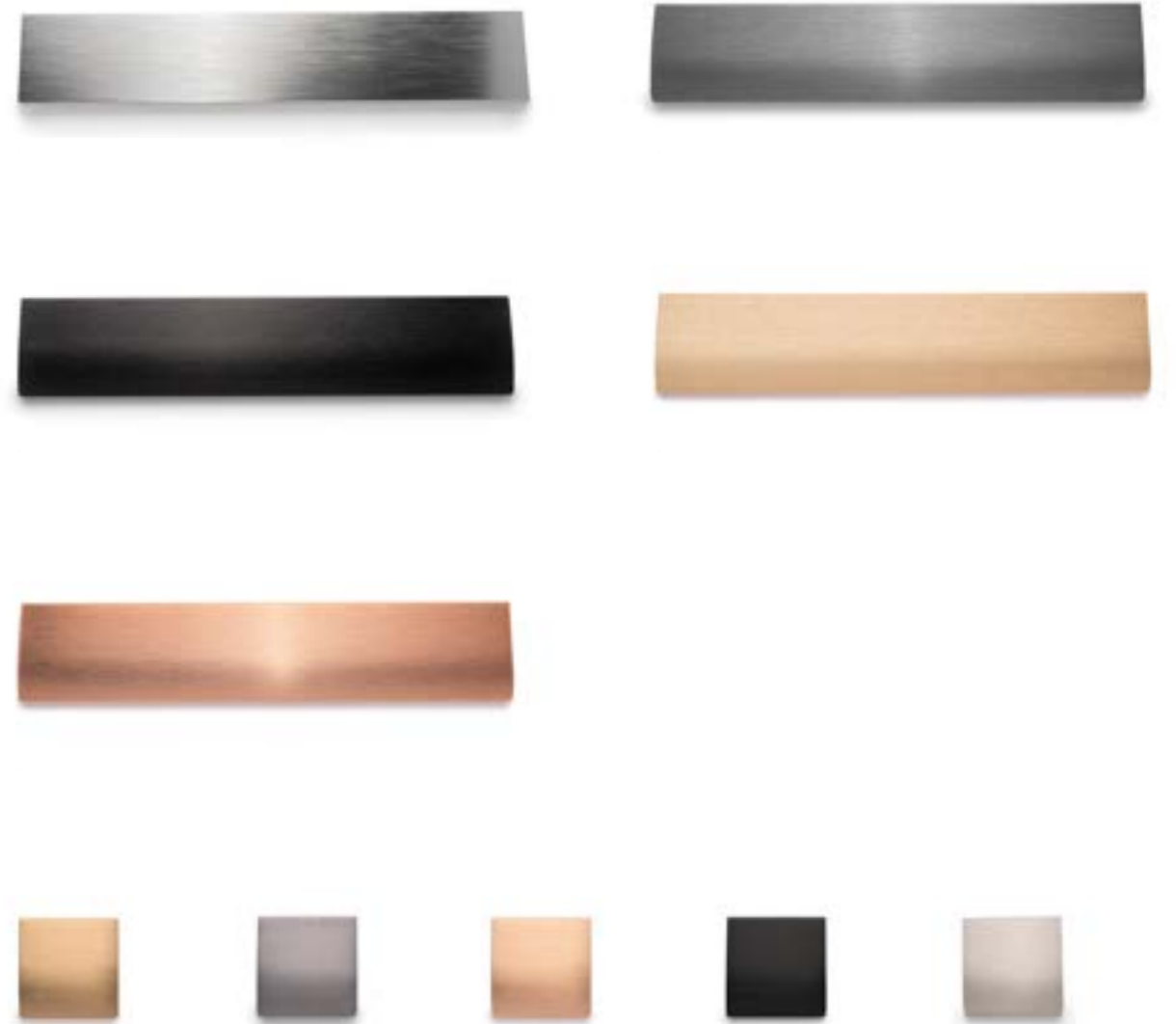

BRUSHED ROSE GOLD  
TAPERED TRIM HANDLE

# Caple Care

The Caple Care Protection plan has been carefully put together to offer you that extra peace of mind.

As the hub of the home, the kitchen is considered the most important room in the house. With this in mind and for that added security, Caple provided a free 5 year guarantee on kitchen furniture as standard to ensure you have complete confidence when investing in your home.





Fourth Way  
Avonmouth  
Bristol  
BS11 8DW

t: 0117 938 1900  
f: 0800 373 163  
e: sales@caple.co.uk  
caple.co.uk



Issue: CA0524

