



# Built-In Freezer Instruction Manual

---

# RIF1797



Contact Caple on 0117 938 7420 for spare parts or [www.caple.co.uk](http://www.caple.co.uk)

## CONTENTS

---

Warnings	3
Environmental Protection	12
Electrical Connection	13
Ventilation Requirements	14
Product Overview	15
Using The Appliance	16
Operating Your Freezer	19
Ice Machine	21
Food Storage	22
Cleaning And Maintenance	27
Transport And Repositioning	29
Troubleshooting	30
Energy Saving Tips	33
Caple Contact Details	36

# SAFETY INSTRUCTIONS

Read these instructions carefully and completely before using your appliance. They provide you with important information regarding the safe installation, use and maintenance of the appliance as well as useful advice for getting the best out of your freezer. Keep this booklet in a safe place for future reference and pass on to any future owner.

- This appliance is produced in accordance with all applicable local and international standards and regulations.
- This appliance is intended to be used in household and similar applications such as:
  - › Staff kitchen areas in shops, offices and other working environments.
  - › Farm Houses.
  - › By clients in hotels, motels and other residential type environments.
  - › Bed and breakfast type environments.
- This appliance may only be used by persons (including children) with reduced physical, sensory or mental capabilities, or lack of experience and knowledge, if they are supervised whilst using it. They may only use it unsupervised if they have been shown how to use it in a safe manner. They must be able to recognise and understand the dangers of misuse.

## **SAFETY WITH CHILDREN:**

- This appliance can be used by children aged from 8 years and above.
- Children less than 8 years of age should be kept away unless continuously supervised or they have been shown how to use it in a safe manner. Children must be able to understand and recognise the possible dangers caused by incorrect operation.
- Children should be supervised in the vicinity of the appliance.
- Never allow children to play with the appliance.
- Cleaning and user maintenance should not be carried out by children without supervision.
- Children aged from 3 to 8 years are allowed to load and unload refrigerating appliances.
- Materials used for packaging (nylon, staplers, Styrofoam etc.) may cause harmful effects to children, they should be disposed of immediately.
- Children can injure themselves on an open door. Do not let children sit on the open door, lean against it or swing on it.

## **TECHNICAL SAFETY:**

- Maintenance and repair work must be made only by authorised Caple service technicians. Installation and repair work that is carried out by unauthorised technicians may endanger you.

- While the appliance is under warranty, repairs should only be undertaken by a Caple authorised service technician. Otherwise the warranty will be invalidated.
- It is dangerous to alter or modify the specifications of the appliance in any way. The requirements for this appliance are stated on the rating label.
- Risk of injury due to electric shock. Any contact with live connections or tampering with the electrical or mechanical components of the appliance will endanger your safety and may lead to the appliance malfunctioning.
- To maintain the efficiency and safety of your appliance, we recommend you always use original spare parts and to call only our authorised Caple Service agents in case of need.
- Multi-socket adapters and extension leads should not be used to connect the appliance to the mains electricity supply.
- The electrical system of this appliance may be used safely only when it is correctly connected to an efficient earthing system in compliance with the safety standards currently in effect.
- Insert the plug into a socket with an efficient ground connection. If the socket has no ground contact or the plug does not match, we recommend you consult a qualified electrician for assistance.
- The appliance must be connected with a properly installed fused socket. The power supply (AC) and

voltage at the operating point must match with the details on the rating plate of the appliance.

- Consult a qualified electrician or service person if the Grounding instructions are not completely understood, or if you have doubts on whether the appliance is properly grounded.
- The incorrect grounding may cause breakdown and electric shock.
- We do not accept responsibility for any damages that occur due to ungrounded usage.
- If the socket does not match the refrigerator plug, it must be replaced by the manufacturer, a service agent or similarly qualified persons in order to avoid a hazard.
- A specially grounded plug has been connected to the power cable of your refrigerator. This plug should be used with a specially grounded socket of 13 amperes. If there is no such socket in your house, please have one installed by an authorised electrician.

## **INSTALLATION WARNINGS:**

- Prior to installation, ensure that the local distribution conditions (electricity voltage and frequency) and the requirements of the appliance are compatible.
- During installation the appliance must be completely disconnected from the mains electricity supply.
- Do not operate the appliance before it is fully installed.

- The appliance must be installed by an authorised technician.
- **⚠ WARNING:** In order to avoid any hazards resulting from the instability of the appliance, it must be fixed in accordance with the following instructions.
- This appliance is not intended for use at altitudes exceeding 2000m.
- Your appliance must be at least 50 cm away from stoves, gas ovens and heater cores, and at least 5 cm away from electrical ovens.
- If your freezer is placed next to a deep freezer, there must be at least 2cm between them to prevent humidity forming on the outer surface.
- Do not cover the body or top of freezer with lace. This will affect the performance of your freezer.
- Clearance of at least 150 mm is required at the top of your appliance. Do not place anything on top of your appliance.
- Caple is not responsible for any damage that may be caused by defective placement and installation by unauthorised persons.
- When unpacking the appliance, make sure that it is not damaged during transportation.
- Check the appliance for any damage.
- In the case of any defect; do not use the appliance and contact your retailer or Caple Service immediately.
- **⚠ WARNING:** When positioning the appliance, ensure

the supply cord is not trapped or damaged. If the supply cord is damaged, it must be replaced by a Caple service technician or similarly qualified persons in order to prevent a hazard.

- Never touch the power cord/plug with wet hands. This may cause a short circuit or electric shock.
- The plug must be accessible after installation.
-  **WARNING:** Do not locate multiple portable socket-outlets or portable power supplies at the rear of the appliance.
- Protect your appliance against atmospheric effects. Do not expose it to effects such as sun, rain, snow etc.

## **DURING USE:**

- Do not store explosive substances such as aerosol cans with a flammable propellant in this appliance.
- Place drinks with high alcohol content vertically in the freezer compartment and make sure their tops are tightly closed.
- If you know you will not be using the appliance for a while switch it off from the main supply and unplug it.
-  **WARNING:** Keep ventilation openings, in the appliance enclosure or in the built-in structure, clear of obstruction.
- Do not place your appliance on a carpeted surface as this will prevent adequate ventilation.
- When the appliance is not in use, we recommend you





- turn it off, and isolate it from the electrical supply.
- This appliance must be used in the vertical position on a flat surface.
  - **!** WARNING: Do not use electrical appliances inside the food storage compartments of the appliance, unless they are of the type recommended by the manufacturer.
  - The manufacturer will not be held liable for any damages that might arise out of incorrect or improper use of the appliance.
  - Do not touch frozen goods with wet hands. Your hands may freeze to the frozen food.
  - Do not eat ice-cream or ice cubes immediately after they are removed from the freezer compartment. Frozen food can cause frost burn to the lips and tongue.
  - Do not re-freeze partially or fully thawed food. This may cause health issues such as food poisoning. Defrosted food may only be re-frozen after it has been cooked.
  - Do not place glass bottles or cans containing carbonated drinks in the freezer compartment as they will burst when the contents freezes.
  - If using the appliance to quickly cool drinks, do not leave bottles inside the freezer compartment for more than 1 hour, otherwise they could burst.

## CLEANING AND MAINTENANCE:

- Clean the appliance thoroughly before use.
- Always switch off the appliance from the mains isolating the electrical supply before any cleaning or maintenance.
-  **WARNING:** Do not use mechanical devices or other means to accelerate the defrosting process, other than those recommended by the manufacturer.

## TRANSPORT:

-  **WARNING:** Do not damage the refrigerant circuit.
- Always transport the appliance in its original packaging and in an upright position.
-  If your appliance uses R600a as a refrigerant, you should take care during transportation and installation to prevent the cooler elements from being damaged. R600a is an environmentally friendly and natural gas, but it is explosive. In the event of a leak due to damage of the cooler elements, move your freezer away from open flames or heat sources and ventilate the room where the appliance is located for a few minutes.
- Never use the door handles for lifting.
- The appliance is heavy and could cause injury, it must be transported by two people.

## DISPOSAL OF OLD APPLIANCE:

- Old freezers and freezers contain isolation material and refrigerant with CFC. Therefore, take care not to harm environment when you are discarding your old freezers.
- If your old freezer or freezer has a lock, break or remove the lock before discarding it, because children may get trapped inside it and may cause an accident.
- Be careful to avoid damaging the pipework before disposal, e.g. by puncturing coolant channels, bending pipework, scratching the surface coating.



**WARNING:** Serious injury or death risk



**RISK OF ELECTRIC SHOCK:** Dangerous voltage risk



**FIRE:** Warning; Risk of fire / flammable materials



**CAUTION:** Injury or property damage risk



**IMPORTANT:** Operating the system correctly



Symbol ISO 7010 W021

Warning; Risk of fire / flammable materials



## ENVIRONMENTAL PROTECTION

Waste electrical products should not be disposed of with household waste. Please recycle where facilities exist. Check with your Local Authority or retailer for recycling advice. This appliance is marked according to the European Directive on Waste Electrical and Electronic Equipment (WEEE).

By ensuring this product is disposed of correctly, you will help prevent potential negative consequences for the environment and human health, which could otherwise be caused by inappropriate waste handling of this product. The symbol on the product indicates that this product may not be treated as household waste. Instead it shall be handed over to the applicable collection point for the recycling of electrical and electronic equipment. Disposal must be carried out in accordance with local environmental regulations for waste disposal.

For more detailed information about treatment, recovery and recycling of this product, please contact your local council, your household waste disposal service or the retailer where you purchased the product.

## CE DECLARATIONS OF CONFORMITY **CE**

This appliance has been manufactured to the strictest standards and complies with all applicable legislation, Low Voltage Directive (LVD) and Electromagnetic Compatibility (EMC).

## UKCA DECLARATIONS OF CONFORMITY **UK CA**

This appliance has been manufactured to the strictest standards and complies with all applicable legislation.

## TECHNICAL FICHE

This appliance conforms to all current and applicable energy regulations. To view the Technical Fiche that supports the energy labelling data, please visit the product page on our website [www.caple.co.uk](http://www.caple.co.uk)

## WARRANTY

Your new appliance is covered by warranty. The warranty card is enclosed - if it is missing, you must provide the following information to your retailer in order to receive a replacement: date of purchase, model and serial number (placed on the inside of the appliance storage drawer). Registration can also be completed online by visiting [www.caple.co.uk](http://www.caple.co.uk).

Ensure you keep your warranty card safe, you may need to show it to Caple Service together with proof of purchase.

If you fail to show your warranty card you will incur all repair charges.

Spare parts are only available from Caple Service and spare parts authorised centres.

## ELECTRICAL CONNECTION

---

For your safety please read the following information



### **WARNING:**

This appliance must be earthed.

This appliance operates from 220-240 volts and should be protected by a 13 amp fuse in the plug.



### **IMPORTANT:**

Do not use the appliance without the fuse cover in position.

The appliance is supplied with a standard 13 amp 3-pin mains plug fitted with a 13-amp fuse. Should the fuse require replacement, it must be replaced with a fuse rated at 13 amp and approved to BS1362.

The mains lead of this appliance has been fitted with a BS 1363A 13A fused plug. To change a fuse in this type of plug, follow the steps below:

1. Remove the fuse cover and fuse.
2. Fit replacement 13A fuse, ASTA approved to BS 1362 type, into the fuse cover.
3. Replace fuse cover.

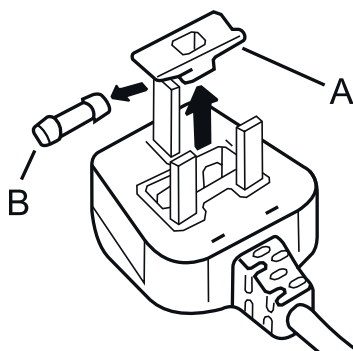

## VENTILATION REQUIREMENTS

The main consideration when installing a refrigeration product into a cabinet is ventilation. The heat removed from the appliance needs to be dissipated into the room. Failure to correctly ventilate the product can result in increased running costs and premature failure. It will also invalidate the guarantee provided with the appliance.

An air intake in the plinth is required to allow for the correct air flow (recommended 500mm x 40mm). If preferred a decorative stainless steel plinth grille is available, product code: GRILL/ SENSE600.

This can be purchased from your retailer or

[www.caple.co.uk](http://www.caple.co.uk).

To ensure the correct operation of the appliance it is important the top of the housing is not blocked off. The top of the cabinet needs to be vented into the room, the recommended minimum size of the vent opening is 500 x 40mm.

There should also be space at the rear of the cabinet to allow the cool air to be drawn over the condenser. This should also be at least 500mm x 40mm. The more air available to circulate the product, the more efficiently it will operate.

### NOTE:

Installation instructions are supplied with the appliance in a separate document. Only the solid metal fixing bracket is included (part 1a) for installation.

Due to different kitchen door styles, thicknesses and materials, ensure you check the suitability of the universal screws provided in the fixing kits, and where required source alternative screws.

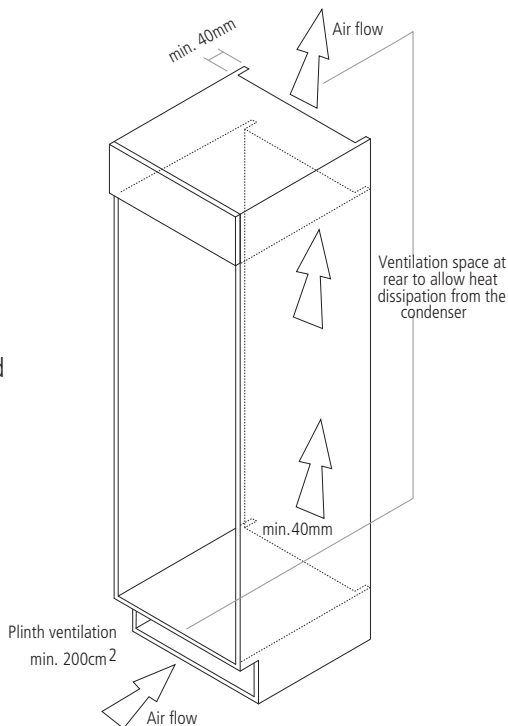

# PRODUCT OVERVIEW

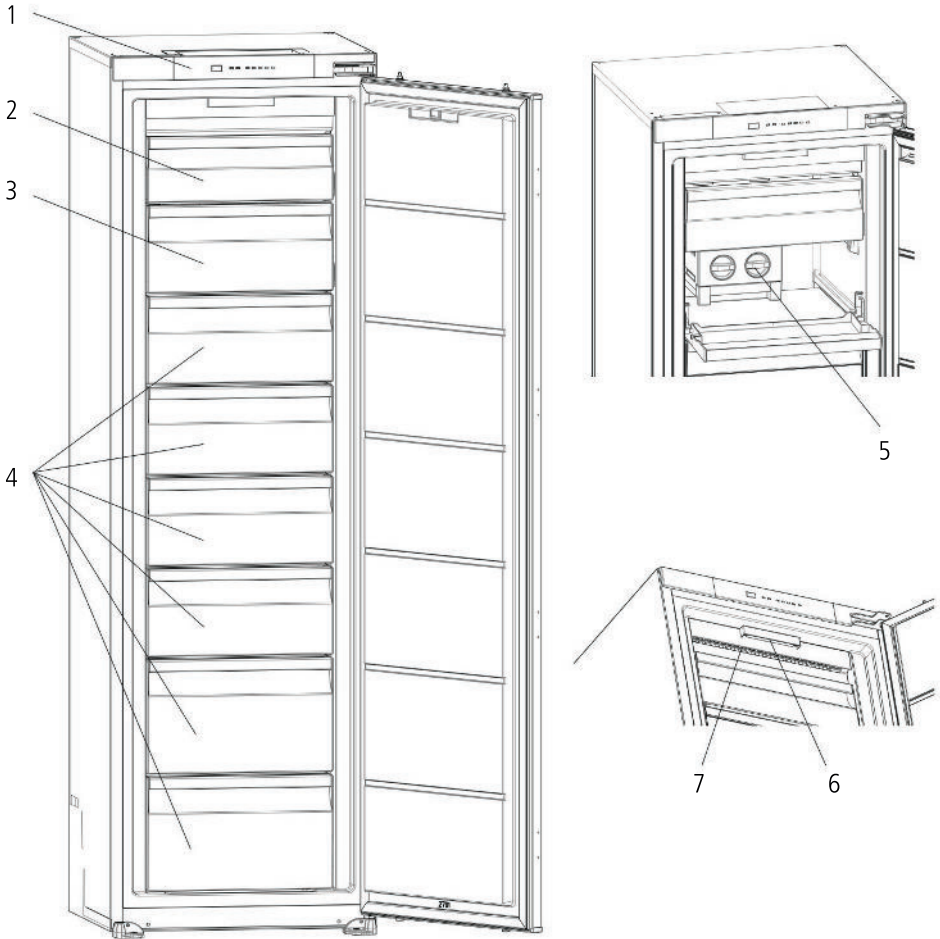

- 1. Control panel
- 2. Freezer upper room cover
- 3. Freezer compartment drawers / freezer room cover
- 4. Freezer compartment drawers
- 5. Ice maker
- 6. Freezer LED strip
- 7. Frost free air circulation system



This presentation is only for information about the parts of the appliance. Parts may vary according to the appliance model.

## USING THE APPLIANCE

---

- › Before using your appliance, wipe all parts with a solution of warm water and a teaspoon of sodium bicarbonate. Then, rinse with clean water and dry. Return all parts to the appliance after cleaning.
- › Remove all transport tapes and foam protection pieces. Clean the interior with a cloth dampened in lukewarm soap and water. Rinse with clean water and dry.
- › The adjustable front legs should be stabilized at an appropriate height to allow your freezer to operate in a stable and proper way. You can adjust the legs by turning them clockwise (or in the opposite direction). This should be done before placing food in the freezer.
- › Install the distance adjustment plastic (the part with black vanes at the rear) by turning it 90°C as shown in the figure to prevent the condenser from touching the wall.
- › Your appliance may have an odour when it is operated for the first time. This is normal and the odour will fade when your freezer starts to cool.

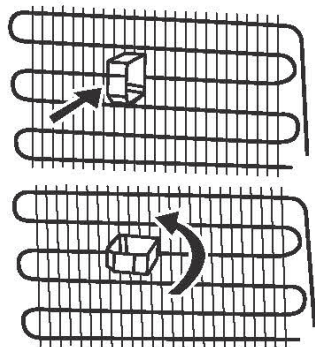

### **WARNING:**

Connect to the electrical socket but do not switch the power to the appliance on for at least 12 hours. The coolant within the product needs time to settle after it has been transported and put into position, failure to do this will affect the cooling performance of your appliance.



## FROST FREE TECHNOLOGY

Frost Free freezers have a different operating system to static freezers.

In normal (static) freezers, the humidity entering the freezer due to opening the door, and the humidity inherent in the food, causes frost build-up in the freezer compartment.

To defrost the frost and ice in the freezer compartment, you are required to periodically switch off the freezer, place the frozen food in a separate cooled container, then remove the ice gathered in the freezer compartment.

The situation is completely different in Frost free freezers. A built-in fan blows dry and cold air evenly throughout the freezer compartment. The cold air disperses uniformly between the compartment, ensuring all your food is cooled equally, thus preventing humidity and frost build-up. Therefore, your Frost Free freezer allows ease of use, in addition to its huge capacity and stylish appearance.

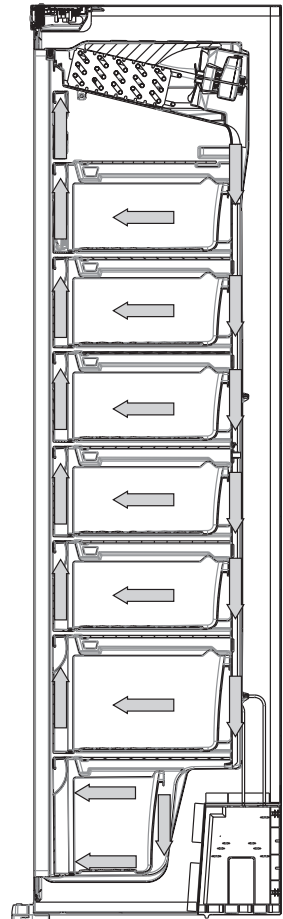

## DISPLAY AND CONTROL PANEL

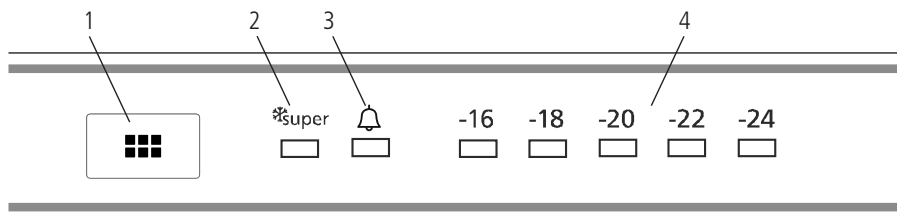

1. Temperature set button
2. Super Freeze mode LED
3. Alarm indicator LED
4. Temperature setting indicator

## OPERATING YOUR FREEZER

---

### TEMPERATURE SET BUTTON

This button allows you to change and set the temperature of the freezer. In order to set the temperature of the freezer, press this button until the desired temperature setting is selected. Use this button also to activate Super Freeze mode.



### TEMPERATURE SETTINGS

- › The initial temperature of the setting display is -18°C.
- › Press the temperature set button once.
- › Every time you press the button, the set temperature will decrease.
- › If you press temperature set button until the Super Freeze symbol is displayed on the display and you do not press any button within the following 3 seconds, the Super Freeze LED will blink.
- › If you keep on pressing the button, it will restart from the last value.

### SUPER FREEZE MODE - WHEN WOULD IT BE USED?

- › To freeze large quantities of food.
- › To freeze fresh food.
- › To freeze food quickly.
- › To store seasonal food for a long time.

### HOW TO USE?

- › Press temperature set button until super freeze light comes on.
- › Super freeze LED will light during this mode.
- ›  For optimal appliance performance in maximum freezing capacity, set the appliance to active Super Freeze mode 24 hours before you put the fresh food into the freezer.
- ›  During this mode if you press the temperature set button, the mode will be cancelled and the setting will be restore back to -16°C. Super freeze mode will be automatically cancelled after 24 hours or when the cooline sensor temperature drops beneath -32°C.

## ALARM LIGHT

- › In case of a problem within the freezer, the alarm LED will illuminate red.

## TEMPERATURE ADJUSTMENT WARNINGS

- › Your temperature adjustments will not be deleted when an energy breakdown occurs.
- › It is not recommended that you operate your freezer in environments colder than 10°C in terms of its efficiency.
- › Do not start another adjustment while you are already making an adjustment.
- › Temperature adjustments should be made according to the frequency of door openings, the quantity of food kept inside the freezer and the ambient temperature in the location of your freezer.
- › In order to allow your freezer to reach the operating temperature after being connected to mains, do not open the doors frequently or place large quantities of food in the freezer. Please note that, depending on the ambient temperature, it may take 24 hours for your freezer to reach the operating temperature.
- › A 5 minute delay function is applied to prevent damage to the compressor of your freezer when connecting or disconnecting to mains, or when an energy breakdown occurs. Your freezer will begin to operate normally after 5 minutes.
- › Your freezer is designed to operate in the ambient temperature intervals stated in the standards, according to the climate class stated on the rating label. We do not recommend operating your freezer out of stated temperatures value limits in terms of cooling effectiveness.
- › This appliance is designed for use at an ambient temperature within the 10°C - 43°C range.

CLIMATE CLASS	AMBIENT TEMPERATURE °C
<b>T</b>	Between 16 and 43 (°C)
<b>ST</b>	Between 16 and 38 (°C)
<b>N</b>	Between 16 and 32 (°C)
<b>SN</b>	Between 16 and 32 (°C)

## ICE MACHINE

---

- › Take out the ice making tray.
- › Fill the water to the line.
- › Place the ice making tray in its original position.
- › When ice cubes are formed, twist the lever to drop ice cubes into the icebox.

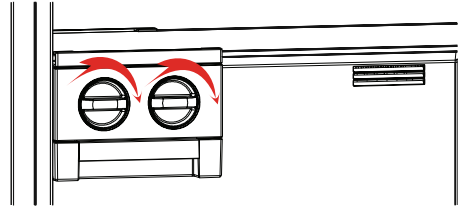

### NOTE:

- › Do not fill the icebox with water to make ice. This may damage it.
- › The movement of the ice maker may be difficult while the freezer is running. In such a case it should be cleaned by removing the glass shelves.

### REMOVING THE ICE MAKER

- › Remove the freezer glass shelves.
- › Remove the icemaker by pulling left or right on the shelf.

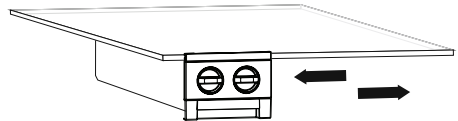

You can remove the icemaker to increase the available volume in the freezer compartment.

## FOOD STORAGE

---

- › The freezer is used for storing frozen food, freezing fresh food, and making ice cubes.
- › To freeze fresh food, ensure that as much of the surface of the food as possible is in contact with the cooling surface.
- › Do not store fresh food next to frozen food as it can thaw the frozen food.
- › Before freezing fresh food, divide it into portions that can be consumed in one sitting.
- › Consume thawed frozen food within a short period of time after defrosting
- › Never place warm food in the freezer compartment as it will thaw the frozen food.
- › Always follow the manufacturer's instructions on food packaging when storing frozen food. If no information is provided food, should not be stored for more than 3 months from the date of purchase.
- › When purchasing frozen food, make sure that it has been stored under appropriate conditions and that the packaging is not damaged.
- › Frozen food should be transported in appropriate containers and placed in the freezer as soon as possible.
- › Do not purchase frozen food if the packaging shows signs of humidity band abnormal swelling. It is probable that it has been stored at an unsuitable temperature and that the contents have deteriorated.
- › The storage life of frozen food depends on the room temperature, the thermostat setting, how often the door is opened, the type of food, and the length of time required to transport the product from the shop to your home. Always follow the instructions printed on the packaging and never exceed the maximum storage life indicated.
- › The maximum amount of fresh food (in kg) that can be frozen in 24 hours is indicated on the appliance label.
- › To use the maximum capacity of the freezer compartment, use the glass shelves for the upper and middle section, and use the lower basket for the bottom section.

### **NOTE:**

If you attempt to open the freezer door immediately after closing it, you will find that it will not open easily. This is normal. Once equilibrium has been reached, the door will open easily.

**IMPORTANT NOTE:**

- › Never refreeze thawed frozen food.
- › The taste of some spices found in cooked dishes (aniseed, watercress, vinegar, assorted spices, ginger, garlic, onion, mustard, thyme, black pepper, etc.) changes and they assume a strong taste when they are stored for a long period of time. Therefore, add small amounts of spices to food to be frozen, or the desired spice should be added after the food has thawed.
- › The storage time of food is dependent on the type of oil used. Suitable oils are margarine, calf fat, olive oil and butter. Unsuitable oils are peanut oil and pig fat.
- › Food in liquid form should be frozen in plastic cups and other food should be frozen in plastic or bags or containers. The table below is a quick guide to show you the most efficient way to store the major food groups in your freezer compartment.

MEAT AND FISH	PREPARATION	MAXIMUM STORAGE TIME (MONTHS)
Steak	Wrap in foil	6 - 8
Lamb meat	Wrap in foil	6 - 8
Veal roast	Wrap in foil	6 - 8
Veal cubes	In small pieces	6 - 8
Lamb cubes	In pieces	4 - 8
Minced meat	In packaging without using spices	1 - 3
Giblets (pieces)	In pieces	1 - 3
Bologna sausage/salami	Should be kept packaged even if it has a membrane	
Chicken and turkey	Wrap in foil	4 - 6
Goose and duck	Wrap in foil	4 - 6
Deer, rabbit, wild boar	In 2.5 kg portions or as fillets	6 - 8
Freshwater fish (Salmon, Carp, Crane, Catfish)	After cleaning the bowels and scales of the fish, wash and dry it. If necessary, remove the tail and head.	2
Lean fish (Bass, Turbot, Flounder)		4
Fatty fishes (Tuna, Mackarel, Bluefish, Anchovy)		2 - 4
Shellfish	Clean and in a bag	4 - 6
Caviar	In its packaging, or in an aluminium or plastic container	2 - 3

**NOTE:**

Thawed frozen meat should be cooked as fresh meat. If the meat is not cooked after defrosting, it must not be re-frozen.



VEGETABLES AND FRUITS	PREPARATION	MAXIMUM STORAGE TIME (MONTHS)
String beans and beans	Wash, cut into small pieces and boil in water	10 - 13
Beans	Hull, wash and boil in water	12
Cabbage	Clean and boil in water	6 - 8
Carrot	Clean, cut into slices and boil in water	12
Pepper	Cut the stem, cut into two pieces, remove the core and boil in water	8 - 10
Spinach	Wash and boil in water	6 - 9
Cauliflower	Remove the leaves, cut the heart into pieces and leave it in water with a little lemon juice for a while	10 - 12
Aubergine	Cut into pieces of 2cm after washing	10 - 12
Sweet corn	Clean and pack with its stem or as sweet corn	12
Apple and pear	Peel and slice	8 - 10
Apricot and Peach	Cut into two pieces and remove the stone	4 - 6
Strawberry and Blackberry	Wash and hull	8 - 12
Cooked fruits	Add 10 % of sugar to the container	12
Plum, cherry, raspberry	Wash and hull the stems	8 - 12

	MAXIMUM STORAGE TIME (MONTHS)	THAWING TIME AT ROOM TEMPERATURE (HOURS)	THAWING TIME IN OVEN (MINUTES)
Bread	4 - 6	2 - 3	4-5 (220-225 °C)
Biscuits	3 - 6	1 - 1.5	5-8 (190-200 °C)
Pastry	1 - 3	2 - 3	5-10 (200-225 °C)
Pie	1 - 1.5	3 - 4	5-8 (190-200 °C)
Filo dough	2 - 3	1 - 1.5	5-8 (190-200 °C)
Pizza	2 - 3	2 - 4	15-20 (200 °C)
DAIRY PRODUCTS	PREPARATION	MAXIMUM STORAGE TIME (MONTHS)	STORAGE CONDITIONS
Packet (Homogenized) Milk	In its own packet	2 - 3	Pure Milk – in its own packet
Cheese - excluding white cheese	In slices	6 - 8	Original packaging may be used for short-term storage. Keep wrapped in foil for longer periods.
Butter, margarine	In its packaging	6	

## CLEANING AND MAINTENANCE

---



Disconnect the unit from the power supply before cleaning.



Do not wash your appliance by pouring water on it.



Do not use abrasive products, detergents or soaps for cleaning the appliance. After washing, rinse with clean water and dry carefully. When you have finished cleaning, reconnect the plug to the mains supply with dry hands.

- › Make sure that no water enters the lamp housing and other electrical components.
- › The appliance should be cleaned regularly using a solution of bicarbonate of soda and lukewarm water.
- › Clean the accessories separately by hand with soap and water. Do not wash accessories in a dish washer.
- › Clean the condenser with a brush at least twice a year. This will help you to save on energy costs and increase productivity.



### **NOTE:**

The power supply must be disconnected during cleaning.

## DEFROSTING THE REFRIGERATOR COMPARTMENT

- › Your refrigerator performs automatic defrosting. The water formed as a result of defrosting passes through the water collection spout, flows into the vaporisation container behind your refrigerator and evaporates there.
- › Make sure you have disconnected the plug of your refrigerator before cleaning the vaporisation container.
- › Remove the vaporisation container from its position by removing the screws as indicated. Clean it with soapy water at specific time intervals. This will prevent odours from forming.

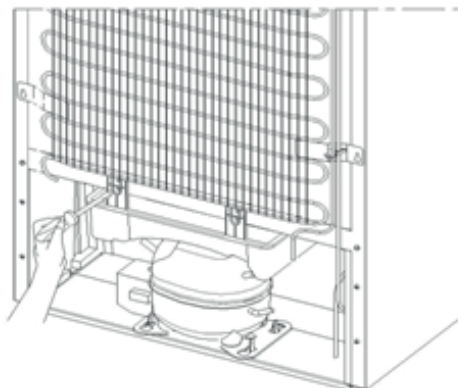

## REPLACING LED LIGHTING

### LIGHT SOURCE ENERGY CLASS

This product contains a light source of energy efficiency class F.

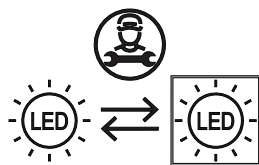

The LED light must be replaced by an authorised engineer or similar only. For more information, please contact Caple service - 0117 938 7420 or [service@caple.co.uk](mailto:service@caple.co.uk)



Unplug the unit from the power supply before starting the process.

1. Carefully remove the 2 screws that secure the light.
2. Remove the LED light from its housing.
3. Disconnect the connector and change the LED light.
4. Implement the steps in reverse order.
5. After waiting 5 minutes, plug the unit.

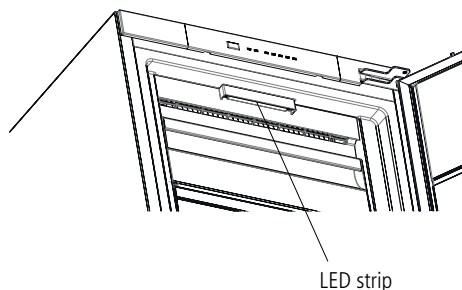

## HOLIDAY

**SHORT HOLIDAYS:** Leave the freezer operating during holidays of less than three weeks.

**LONG HOLIDAYS:** If the appliance will not be used for several months, remove all items and turn off the appliance. Clean and dry the interior thoroughly. To prevent odour and mould growth, leave the door open slightly (blocking it open if necessary).

## TRANSPORT AND REPOSITIONING

---

### TRANSPORTATION AND CHANGING POSITIONING

- › The original packaging and foam may be kept for re-transportation (optional).
- › Fasten your appliance with thick packaging, bands or strong cords and follow the instructions for transportation on the packaging.
- › Remove all movable parts (shelves, accessories, vegetable bins, and so on) or fix them into the appliance against shocks using bands/tape when re-positioning or transporting.
- ›  Always carry your appliance in the upright position.

## TROUBLESHOOTING

### BEFORE CALLING FOR SERVICE

Reviewing the information below may save you from calling for service.

### ERRORS

Your freezer will warn you if the temperature for the freezer are at improper levels or if a problem occurs with the appliance.

If your freezer is not working properly, it may be a minor problem, therefore check the following, before calling an electrician to save time and money.

ALARM INDICATOR LED IS TURNING ON	MEANING	WHY	WHAT TO DO
	Failure Warning	<p>There is/are some part(s) out of order or there is a failure in the cooling process.</p> <p>The product has been plugged in for the first time, or power has been interrupted for more than 1 hour.</p>	<p>Check if the door is open or not. Check the appliance in 1 hour to see if it is now working, and the alarm has turned off. If the door is not open, or the appliance is still not working after 1 hour, call Caple service for assistance.</p>

### THE APPLIANCE DOES NOT OPERATE CHECK IF:

- › There is power to the unit
- › The general switch in your home is connected
- › The socket is working. To check this, plug in another appliance that you know is working into the same socket.

### THE APPLIANCE PERFORMS POORLY CHECK IF:

- › You have not overloaded the appliance
- › The freezer temperature set to -16
- › The door is closed perfectly
- › There is no dust on the condenser
- › There is enough space at the rear and side walls for ventilation

## **WHY IS MY FREEZER OPERATING LOUDLY?**

### **CRACKING (ICE CRACKING):**

- › During automatic defrosting.
- › When the appliance is cooled or warmed (due to expansion of appliance material).

### **SHORT CRACKING:**

Heard when the thermostat switches the compressor on/ off.

### **COMPRESSOR NOISE:**

Normal motor noise. This noise means that the compressor operates normally. Compressor may cause more noise for a short time when it is activated.

### **BUBBLING NOISES:**

This noise is caused by the flow of the refrigerant in the tubes of the system.

### **WATER FLOW NOISE:**

Normal flow noise of water flowing to the evaporation container during defrosting. This noise can be heard during defrosting.

### **AIR BLOW NOISE:**

Normal fan noise. This noise can be heard in freezer during normal operation of the system due to the circulation of air.

### **DOOR JOINTS**

If the edges of freezer cabinet that the door joints contact are warm; especially in summer (hot weather), the surfaces that the joint contact may get warmer during the operation of the compressor, this is normal. If humidity builds up inside the freezer.

## **IS ALL THE FOOD PACKED PROPERLY?**

- › Are the containers dried before placing them in the freezer?
- › Are the freezer's doors opened frequently? Humidity of the room gets in the freezer when the door is opened. Humidity build up will be faster when you open the door more frequently, especially if the humidity of the room is high.

## **IF THE DOORS ARE NOT OPENED AND CLOSED PROPERLY**

- › Do the food packages prevent closing of the door?
- › Are the door compartments, shelves and drawers placed properly?
- › Are door joints broken or torn?
- › Is your freezer on a level surface?

## **RECOMMENDATIONS**

- › To stop the appliance completely, unplug from main socket (for cleaning and when the door is left open).

If the problem persists or more help is required, please contact our Caple service team on **0117 938 7420** or via email [service@caple.co.uk](mailto:service@caple.co.uk)

## **SPARE PARTS AVAILABILITY**

The original spare parts for some specific components are available for a minimum of 7 or 10 years, based on the type of component, from the placing on the market of the last unit of the model.

For more info and to order spares, please contact Caple service or visit our website [www.caple.co.uk](http://www.caple.co.uk).



## ENERGY SAVING TIPS

---

1. Install the appliance in a cool, well ventilated room, but not in direct sunlight and not near a heat source (such as a radiator or oven) otherwise an insulating plate should be used.
2. Allow warm food and drinks to cool before placing them inside the appliance.
3. Place thawing food in the refrigerator compartment. The low temperature of the frozen food will help cool the refrigerator compartment while the food is thawing. This will save energy. Frozen food left to thaw outside of the appliance will result in a waste of energy.
4. Drinks or other liquids should be covered when inside the appliance. If left uncovered, the humidity inside the appliance will increase, therefore the appliance uses more energy. Keeping drinks and other liquids covered helps preserve their smell and taste.
5. Avoid keeping the doors open for long periods and opening the doors too frequently as warm air will enter the appliance and cause the compressor to switch on unnecessarily often.
6. Keep the covers of the different temperature compartments (such as the crisper and chiller) closed.
7. The door gasket must be clean and pliable. Replace gaskets if worn.

**NOTES:**

**NOTES:**



Caple Service  
Fourth Way  
Avonmouth  
Bristol  
BS11 8DW

T: 0117 938 1900  
E: [service@caple.co.uk](mailto:service@caple.co.uk)  
[www.caple.co.uk](http://www.caple.co.uk)