



Freestanding Wine Cabinet Instruction Manual

WF1552 & WF1553



Contact Caple on 0117 938 7420 for spare parts or www.caple.co.uk

CONTENTS

Introduction	3
Safety Instructions	4
Environmental Protection	7
Product Overview	8
Installation	9
Operating Your Wine Cabinet	11
Control Panel	13
Using the Shelves	15
How to Replace the Charcoal Filter	16
How to Change the Door Opening	18
Wine Bottle Stacking	21
Installation for Built-In Purposes	22
Care and Maintenance	23
Troubleshooting	25
Recommended Temperatures	27
Caple Contact Details	28

INTRODUCTION

Thank you for choosing this Caple Wine Cabinet.

To ensure that you get the best results from your new wine cabinet, we strongly suggest that you read this instruction manual thoroughly before use. If treated with care, your Caple product should give you years of trouble-free use.

To register ownership, please ensure you complete and return the guarantee card supplied with the appliance or visit www.caple.co.uk and register here.

This instruction manual is designed to provide you with all the required information related to the installation, use and maintenance of the appliance.

Please read this manual carefully before using your appliance. It contains important safety advice; it explains how to use and look after your appliance so that it will provide you with many years of reliable service.

Should a fault arise, please first consult the "Troubleshooting" section. You can often rectify minor problems yourself, thus saving unnecessary service costs.

Please keep this manual in a safe place and pass it on to new owners for their information and safety.

WARNINGS

- To prevent damaging the door gasket, make sure the door is fully open when pulling shelves out of the rail compartment.
- The appliance must be positioned so that the plug is accessible. Release the electric cord and move your cabinet to its final location. Do not move your cabinet while loaded with wine as you may distort the body.
- The wine cabinet should be installed in a suitable place in order to avoid touching the compressor.
- After unpacking, make sure that the appliance is in perfect order. If you have any doubt, do not use it and contact your retailer.
- If the supply cord is damaged, it must be replaced by a Caple service agent or a similarly qualified person in order to avoid a hazard.
- This product is not designed for commercial use, it is a household appliance only.
- This appliance is intended to be used in household and similar applications such as:
 - › Staff kitchen areas in shops, offices and other working environments.
 - › Farm Houses.
 - › By clients in hotels, motels and other residential type environments.
 - › Bed and breakfast type environments.
- This appliance is intended to be used exclusively for the storage of wine.

IMPORTANT

Caple cannot be held liable for any non compliance with these instructions.

ELECTRICAL SHOCK HAZARD

- Read all instructions before using the wine cabinet.
- DANGER or WARNING: Risk of child entrapment.
- Before you throw away your old wine cabinet: Take off the door, leaving the shelves in place so that children cannot easily climb inside.
- Never allow children to operate, play with, or crawl inside the appliance.
- Never clean appliance parts with flammable fluids. The fumes can create a fire hazard or explosion.
- Do not store or use gasoline or any other flammable vapours and liquids in the vicinity of this or any other appliance. The fumes can create a fire hazard or explosion.
- The refrigerant of this appliance is R600a, flammable and explosive articles should not be put in or near the cabinet, to avoid the risk of fire or explosion.
- Cleaning and user maintenance shall not be made by children without supervision.
- When positioning the appliance, ensure the supply cord is not trapped or damaged.

- This appliance can be used by children aged from 8 years and above and persons with reduced physical, sensory or mental capabilities or lack of experience and knowledge if they have been given supervision or instruction concerning use of the appliance in a safe way and understand the hazards involved. Children shall not play with the appliance.
- Do not locate multiple portable socket-outlets or portable power supplies at the rear of the appliance.
- Do not use plug adapter.
- Store wine in sealed bottles.
- Do not overload the cabinet.
- Do not open the door unless necessary.
- Do not cover shelves with aluminium foil or any other shelf material which may prevent air circulation.
- Should the wine cabinet be stored without use for long periods it is suggested, after careful cleaning, to leave the door ajar to allow air to circulate inside the cabinet in order to avoid possible formations of condensation, mould or odours.
- Keep ventilation openings, in the appliance enclosure or in the built-in structure, clear of obstruction.
- Do not damage the refrigerant circuit.
- Do not use electrical appliances inside the storage compartments of the appliance, unless they are the type recommended by the manufacturer.



Symbol ISO 7010 W021

Warning; Risk of fire / flammable materials



ENVIRONMENTAL PROTECTION

Waste electrical products should not be disposed of with household waste. Please recycle where facilities exist. Check with your Local Authority or retailer for recycling advice. This appliance is marked according to the European Directive on Waste Electrical and Electronic Equipment (WEEE).

By ensuring this product is disposed of correctly, you will help prevent potential negative consequences for the environment and human health, which could otherwise be caused by inappropriate waste handling of this product. The symbol on the product indicates that this product may not be treated as household waste. Instead it shall be handed over to the applicable collection point for the recycling of electrical and electronic equipment. Disposal must be carried out in accordance with local environmental regulations for waste disposal.

For more detailed information about treatment, recovery and recycling of this product, please contact your local council, your household waste disposal service or the retailer where you purchased the product.

CE DECLARATIONS OF CONFORMITY **CE**

This appliance has been manufactured to the strictest standards and complies with all applicable legislation, Low Voltage Directive (LVD) and Electromagnetic Compatibility (EMC).

UKCA DECLARATIONS OF CONFORMITY **UK CA**

This appliance has been manufactured to the strictest standards and complies with all applicable legislation.

TECHNICAL FICHE

This appliance conforms to all current and applicable energy regulations. To view the Technical Fiche that supports the energy labelling data, please visit the product page on our website www.caple.co.uk

WARRANTY

Your new appliance is covered by warranty. The warranty card is enclosed - if it is missing, you must provide the following information to your retailer in order to receive a replacement: date of purchase, model and serial number (placed on the inside of the appliance storage drawer). Registration can also be completed online by visiting www.caple.co.uk.

Ensure you keep your warranty card safe, you may need to show it to Caple Service together with proof of purchase.

If you fail to show your warranty card you will incur all repair charges.

Spare parts are only available from Caple Service and spare parts authorised centres.

PRODUCT OVERVIEW

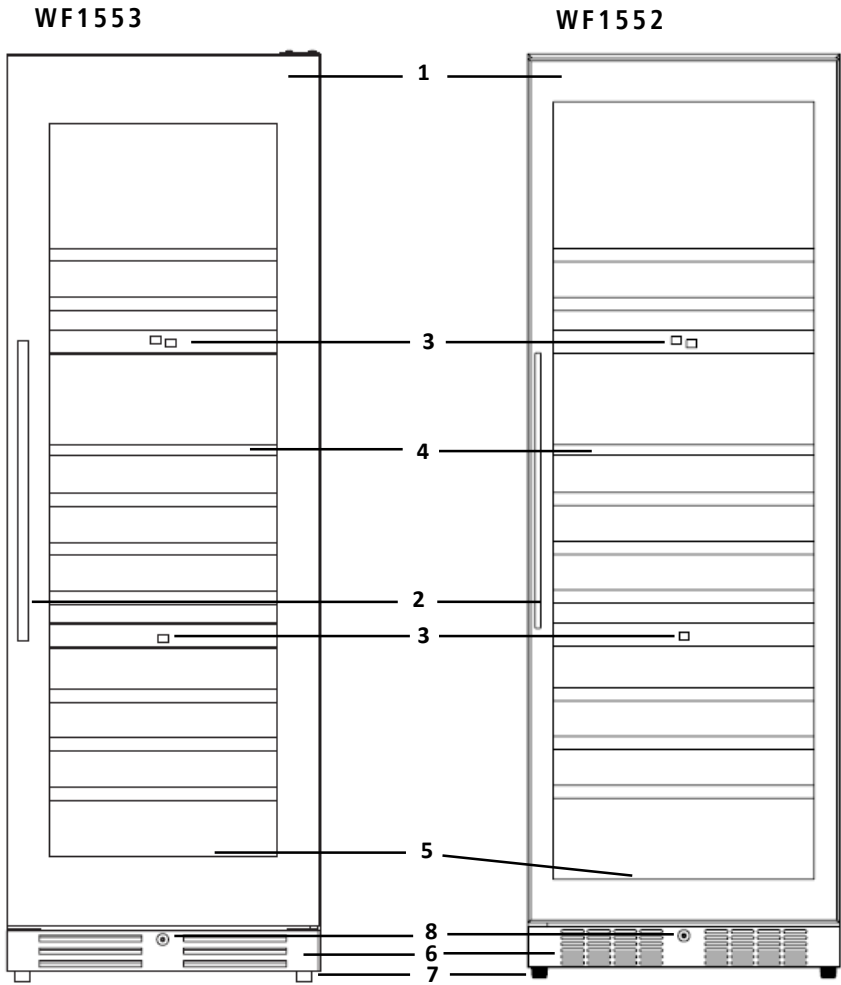

- 1. Door
- 2. Handle
- 3. Digital Control Panel
- 4. Large Shelves
- 5. Small Bottom Shelf
- 6. Bottom Grille
- 7. Levelling Legs
- 8. Security Lock

INSTALLATION

Before using your wine cabinet:

- › Remove the exterior and interior packing.

IMPORTANT

Before connecting the wine cabinet to the power source, let it stand upright for at least 2 hours. This will reduce the possibility of a malfunction in the cooling system from handling during transportation.

- › Clean the interior surface with lukewarm water using a soft cloth. Make sure to turn the unit off and unplug it from the outlet.

NOTE

To protect the appliance in transit and delivery the door is packed tightly against the cabinet. When first installed this can mean the door seal appears thinner on one side of the door due to compression, this is normal and once out of the box it will relax over a short period of time and the door will return to the normal position.

If you wish to speed up the process you can gently warm the seal with a hair dryer on a low temperature setting. This can help relax the seal helping it return to normal thickness a little faster.

INSTALLATION OF YOUR WINE CABINET:

- › This appliance is designed to be for free standing installation.
- › This appliance is intended to be used exclusively for the storage of wine or beverages.
- › Place your wine cabinet on a floor that is strong enough to support it when it is fully loaded.
- › To level your wine cabinet, adjust the front levelling leg at the bottom of the wine cabinet.
- › Ensure it is perfectly level, as this will minimise any vibrations.
- › This appliance uses flammable refrigerant. Never damage the cooling pipework during transportation.
- › Locate the wine cabinet away from direct sunlight and sources of heat (ovens, hobs, heaters, radiators, etc.).

- › Never clean appliance parts with flammable fluids. The fumes can create a fire hazard or explosion. When disposing your appliance, please choose an authorized disposal site.
- › Avoid locating the unit in moist areas.
- › This appliance is using flammability refrigerant. So never damage the cooling pipework during the transportation, locate the Wine cabinet away from direct sunlight and sources of heat (stove, heater, radiator, etc.). Direct sunlight may affect the acrylic coating and heat sources may increase electrical consumption. Extreme cold ambient temperatures may also cause the unit not to perform properly.
- › Avoid locating the unit in moist areas.
- › It is fitted with a power cord having an earth wire terminating in a 13amp plug.
- › Plug the Wine cabinet into an exclusive, properly installed, grounded wall outlet. Do not under any circumstances cut or remove the third (ground) pin from the plug. Any questions concerning power and/or grounding should be directed toward a certified electrician or Caple Service.

WARNING

Incorrect earthing can result in the risk of electric shock.





OPERATING YOUR WINE CABINET

Please use the cabinet within ambient temperatures between 16-32°C, if the ambient temperature is higher or lower than this, it will cause the temperature to fluctuate in the cabinet, possibly preventing it from reaching 5-18°C.



SETTING THE TEMPERATURE

The Upper and Middle zones of the wine cabinet are controlled separately from the Lower compartment which has its own control panel.

UPPER AND MIDDLE ZONE

- › The temperature setting has the following range:
 - Upper compartment: 5 - 18°C
 - Middle compartment: 5 - 10°C
- › When the system enters the temperature set up. With each press of the  key, the temperature setting of the upper zone will decrease by 1°C. When the temperature setting reaches the lower limit of 5°C, the temperature will return to 18°C. With each press of the  key, the temperature setting of the middle zone will decrease by 1°C. When the temperature setting reaches the lower limit 5°C, the temperature will return to 10°C.
- › To view the actual temperature inside the wine cabinet, press the  or  key and hold for approximately 5 seconds. The actual temperature of the upper or middle zone will be displayed on the control board. After 5 seconds the temperature will return to the set temperature.
- › Flashing LED = Cabinet Temperature
- › Steady LED = Set Temperature

LOWER ZONE

- › The temperature setting has the following range:
Lower compartment: 10 - 18°C
- › To view the actual temperature inside the wine cabinet, press the  or  key and hold for approximately 5 seconds. The actual temperature of the upper or middle zone will be displayed on the control board. After 5 seconds the temperature will return to the set temperature.
- › Flashing LED = Cabinet Temperature
- › Steady LED = Set Temperature

NOTE

If the unit is unplugged, power lost or turned off, you must wait 3 to 5 minutes before restarting the unit. If you attempt to restart before this time delay, the wine cabinet will not start.

When you use the wine cabinet for the first time or you restart the cabinet after having been shut off for a long time, there could be a few degrees variance between the temperature you select and the one indicated on the LED readout. This is normal and it is due to the length of the activation time. Once the wine cabinet has been running for a few hours everything will be back to normal.

TEMPERATURE RECOLLECTION FUNCTION

In the event of a power interruption, the wine cabinet remembers the previous temperature settings. When the power is recovered, the cabinet temperature will go back the same setting temperature prior to powering off.

TEMPERATURE ALARM

If internal cabinet temperature is higher than 23°C, "HI" is shown in the display panel, and the alarm sounds after one hour continuously to warn that the inner temperature is too high.

If internal temperature is lower than 0°C, "LO" is shown in the display panel, the alarm sounds and the malfunction indicator lights up at the same time.



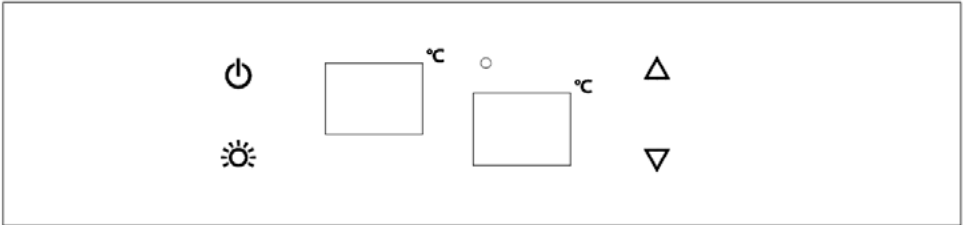

CONTROL PANEL

UPPER AND MIDDLE ZONE



○ Indicator light illuminates to signify the cooling mode is currently in operation.

TOUCH CONTROL KEYS

SYMBOL	SETTING
	Used to switch the internal light on/off
	To switch the appliance on/off (press and hold this button for approximately 3 seconds)
	To set the temperature of the upper compartment
	To set the temperature of the middle compartment

UPPER WINDOW

Displays the temperature in the upper compartment

LOWER WINDOW

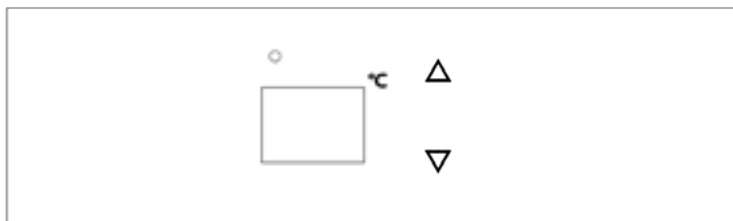

Displays the temperature in the middle compartment

LOWER ZONE



○ Indicator light illuminates to signify the cooling mode is currently in operation.



TOUCH CONTROL KEYS

SYMBOL	SETTING
	To increase the temperature by 1°C
	To decrease the temperature by 1°C

WINDOW

Displays the temperature in the lower compartment

NOTE

Press and hold both  and  for 3 seconds to change the display from °C to °F.

INTERNAL LIGHT

In order to reduce energy consumption, the LED light within this wine cabinet will automatically switch off after 10 minutes. If you would prefer the LED light to remain on continuously, this is possible. Please press and hold  key for 5 seconds and the display will show "LP". After 4 seconds the display will revert back to normal and the light will remain on until manually switched off.

If you would like to revert back and conserve energy (recommended), press and hold the  key for 5 seconds and the display will show "LF". After 4 seconds the display will revert back to normal, and the light will automatically switch off after 10 minutes.

LIGHT SOURCE ENERGY CLASS

This product contains a light source of energy efficiency class G

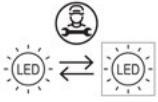

NOTE:

The light must be replaced by qualified personnel. For instructions on how to replace the light, please contact Caple Service or visit our website.

USING THE SHELVES

To prevent damaging the door gasket, make sure to have the door fully opened when pulling shelves out of the rail compartment.

For easy access to the storage content, you can pull the shelves approximately 1/3 out of the rail compartment.

REMOVING THE SHELVES

The cabinet is designed with a notch on each side of the shelf tracks to prevent bottles from falling.

To remove a shelf, first pull it outward until it stops at the notch. Then lift the edge of the shelf upward and pull out of the cabinet (shown below).

To reinstall a shelf, follows the above instructions in reverse.

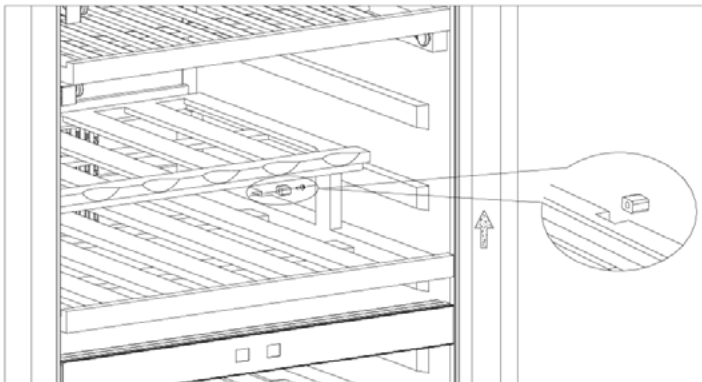

HOW TO REPLACE THE CHARCOAL FILTER

Charcoal filters are located in the top left corner of each wine cabinet zone.

1. Open the door and remove the top 2 shelves (see removing the shelves).
2. Turn the filter as per Fig A.
3. As per Fig B, the filter should line up with the notches as shown.
4. Pull the filter out (Fig C).
5. Insert replacement filter and twist as per Fig A to lock into position.
6. Re-install the shelves.

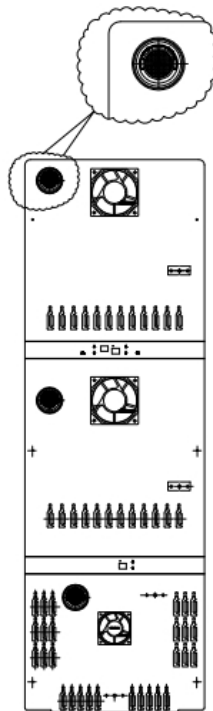

Fig. A

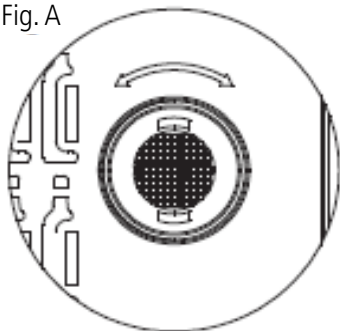

Fig. B

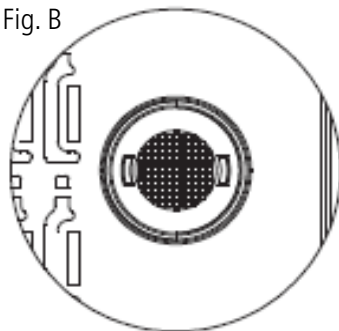
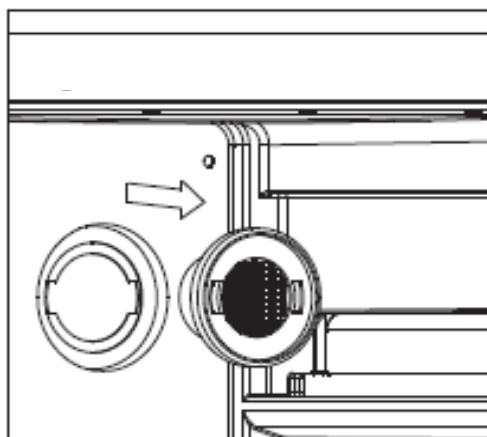

Fig. C



NOTE

The charcoal filter should be replaced every 3-6 months depending on the unit's exposure level to odour.

Visit www.caple.co.uk to purchase the replacement charcoal filters.

HOW TO CHANGE THE DOOR OPENING

This appliance has reversible doors but is delivered with a right hinged door. The left-hand hinge kit comes with the unit (in the box), should you wish to reverse the hinge on your unit, follow the directions below:

Fig. A

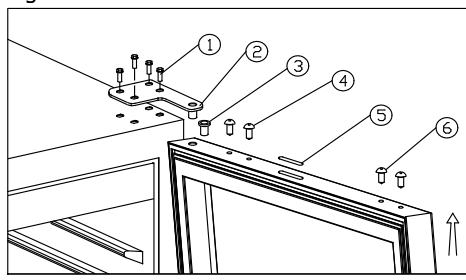

Fig. B

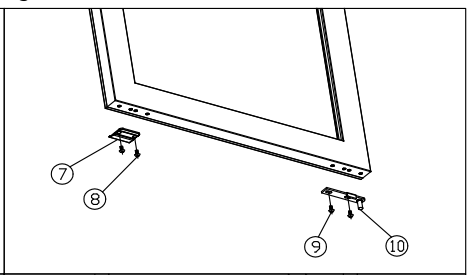

Fig. C

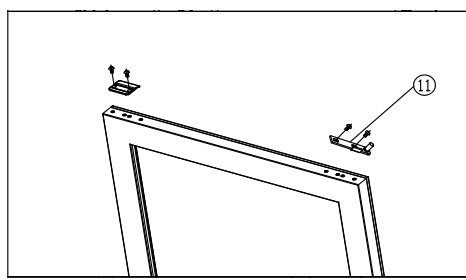

Fig. D

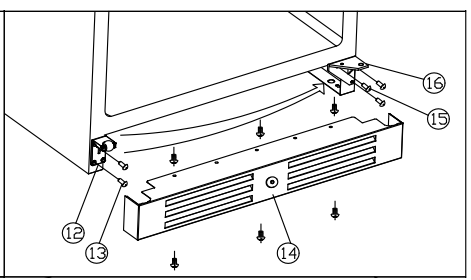

Fig. E

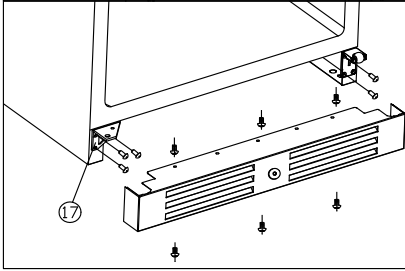
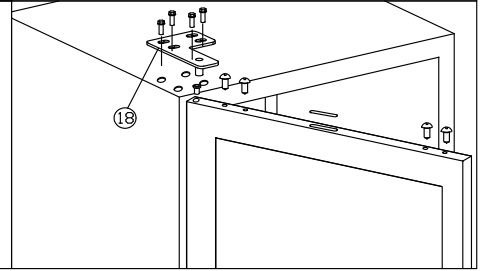

Fig. F



1. Right Door Axis Supporter
2. Left Door Axis Supporter
3. Door Supporter
4. Door Supporter Screw
5. Plinth
6. Lower Door Hinge Screw
7. Right Lower Hinge
8. Left Lower Hinge
9. Left Upper Hinge
10. Upper Door Hinge Screw
11. Right Upper Hinge
12. Door Axis Tube
13. Decoration Nail
14. Decoration Cover
15. Decoration Nail
16. Door Movement Plate
17. Door Movement Plate screw
18. Right Door Axis Supporter Screw

1. Uninstall the upper hinge screw with screw driver (1) and then take out the right upper hinge (2). Refer to Fig. A.
2. Move up and take out of the door. Put the door carefully. Refer to Fig.A
3. Take out the upper door axis tube (3) decoration nail (4)(6) and decoration cover (5). Refer to Fig.A.
4. Uninstall the left lower door movement plate screw (8) and take out the door movement plate. Refer to Fig B.
5. Uninstall the right lower door axis supporter screw (9) and take out right door axis supporter (10). Refer to Fig B.
6. Install the door movement plate (7) onto the left upper corner of the door; Take out the left door axis supporter (11) and door axis tube from accessory bag and install the left door axis supporter (11) onto right upper corner of the door; install the door axis tube onto right lower corner of the door. Refer to Fig. C.
7. Uninstall the 6pcs screw of plinth and take out plinth (14); Uninstall the right lower door hinge screw (15) and door supporter screw (13); Take out the right lower hinge (16) and door supporter (12); Then Install the door supporter to right side. Refer to Fig.D.
8. Take the left lower door hinge (17) from the accessory bag and then install it to left side; Then install the plinth back; Refer to Fig E.
9. Rotate the door by 180 degree and insert the door axis pin into the left lower door hinge hole; Close the door and finally install the left upper door hinge (18); Put back the decoration nail and decoration cover. Fig F.

DOOR LOCK

Our unit is provided with a lock and key combination.

The keys are located inside the plastic bag that contains the User's Guide. Insert the key into the lock and turn it counter clockwise to unlock the door. To lock the door, do the reverse operation making sure metal pin is engaged completely. Remove the key and place it in a secure place for safekeeping.

WINE BOTTLE STACKING

Stores max. 111 Bordeaux style bottles 750ml.

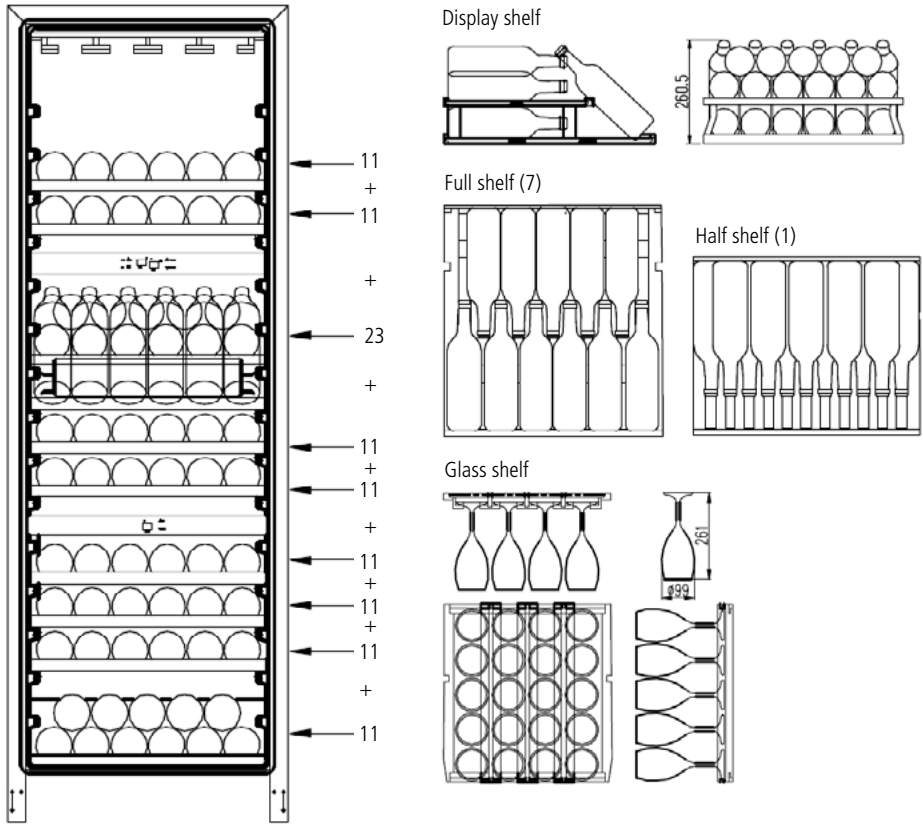

NOTE

If you wish to store other style bottles i.e champagne, the maximum storage capacity will be less than as shown above.

Shelves may also need to be removed to allow more bottles to be stored.

ACCESSORIES

Two extra shelves (WSHELF1) are available if you wish to have further storage in the upper zone of your wine cabinet. These can be purchased directly from www.caple.co.uk.

INSTALLATION FOR BUILT IN PURPOSES

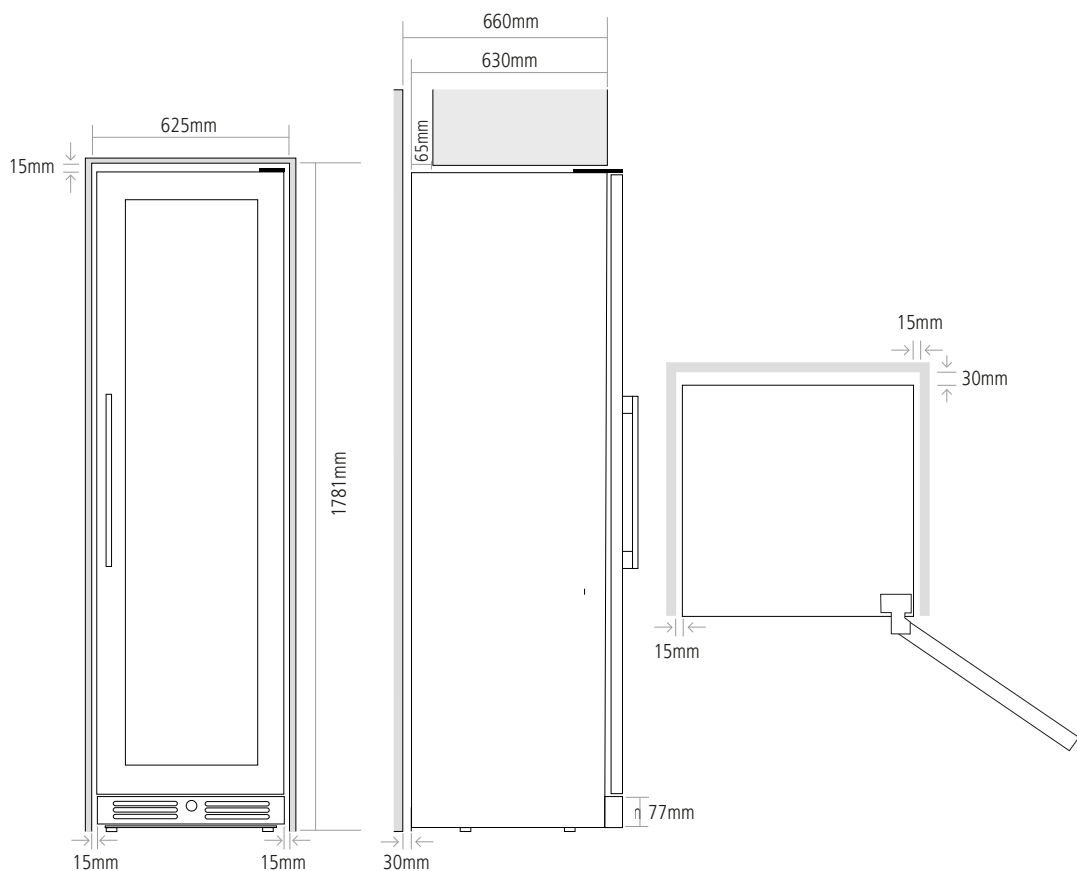

CARE AND MAINTENANCE

CLEANING YOUR WINE CABINET

- › Turn off the power, unplug the appliance, and remove all items including shelves and rack.
- › Wash the inside surfaces with a warm water and baking soda solution. The solution should be about 2 tablespoons of baking soda to 2 pints of water.
- › Wash the shelves with a mild detergent solution.
- › Wring excess water out of the sponge or cloth when cleaning area of the controls, or any electrical parts.
- › Wash the outside cabinet with warm water and mild liquid detergent. Rinse well and wipe dry with a clean soft cloth.

POWER FAILURE

Most power failures are corrected within a few hours and should not affect the temperature of your appliance if you minimise the number of times the door is opened. If the power is going to be off for a longer period of time, you need to take the proper steps to protect your contents.

HOLIDAY

SHORT HOLIDAYS: Leave the wine cabinet operating during holidays of less than three weeks.

LONG HOLIDAYS: If the appliance will not be used for several months, remove all items and turn off the appliance. Clean and dry the interior thoroughly. To prevent odour and mould growth, leave the door open slightly (blocking it open if necessary).

MOVING YOUR WINE CABINET

- › Remove all items.
- › Securely tape down all loose items (shelves) inside your appliance.
- › Turn the adjustable leg up to the base to avoid damage.
- › Tape the door shut.
- › Be sure the appliance stays secure in the upright position during transportation. Also protect outside of appliance with a blanket, or similar item.

ENERGY SAVING TIPS

The Wine Cabinet should be located in the coolest area of the room, away from heat producing appliances, and out of the direct sunlight.

CLOSING THE DOOR

Close the door with care as slamming the door puts excess stress on the appliance and can cause the door to bounce open slightly. If this is not noticed, it can cause excess moisture to build up in the cabinet which in extreme cases can lead to the evaporation tray overflowing.

TROUBLESHOOTING

You can solve many common wine cabinet problems easily, saving you the cost of a possible service call. Try the suggestions below to see if you can solve the problem before calling **Caple Service**.

PROBLEM	POSSIBLE CAUSE
The wine cabinet does not operate.	<ul style="list-style-type: none"> › Not plugged in. › The appliance is turned off. › The circuit breaker tripped or a blown fuse.
The wine cabinet is not cold enough.	<ul style="list-style-type: none"> › Check the temperature control setting. External environment may require a higher setting. › The door is opened too often. › The door is not closed completely. › The door gasket does not seal properly.
The compressor turns on and off frequently.	<ul style="list-style-type: none"> › The room temperature is hotter than normal. A large amount of contents has been added to the wine cabinet. › The door is opened too often. › The door is not closed completely. › The temperature control is not set correctly. › The door gasket does not seal properly.
The light does not work.	<ul style="list-style-type: none"> › Not plugged in. › The circuit breaker tripped or a blown fuse. › The bulb has burned out. › The light button is "OFF".
Vibrations.	Check to assure that the wine cabinet is level.
The wine cabinet seems to make too much noise.	<ul style="list-style-type: none"> › The rattling noise may come from the flow of the refrigerant, which is normal. As each cycle ends, you may hear gurgling sounds caused by the flow of refrigerant in your wine cabinet. › Contraction and expansion of the inside walls may cause popping and crackling noises. › The wine cabinet is not level.
The door will not close properly.	<ul style="list-style-type: none"> › The wine cabinet is not level. › The door was reversed and not properly installed. › The gasket is dirty. › The shelves are out of position.

If the above table has not solved the problem please contact Caple Service by phone on **0117 938 7420** or by email **service@caple.co.uk**

DEFROSTING/CONDENSATION

Your wine cabinet is designed with an "Auto-cycle" defrost system. When the RUN cycle is OFF, the refrigerated surface of the wine cabinet (interior rear wall) defrosts automatically. The defrosted water is channelled into a drain pan which is located at the back of the cabinet next to the compressor from where it evaporates.

HUMIDITY SYSTEM

The wine cabinet is equipped with a system for maintaining the correct level of humidity. If humidity is too low, insert the small plastic reservoir on to the top shelf. Fill this reservoir 3/4 full with water. Check the water level occasionally and refill as necessary.

SPARE PARTS AVAILABILITY

The original spare parts for some specific components are available for a minimum of 7 or 10 years, based on the type of component, from the placing on the market of the last unit of the model.

For more info and to order spares, please contact Caple service or visit our website www.caple.co.uk.

RECOMMENDED TEMPERATURES

RECOMMENDED STORAGE TEMPERATURES:

DRINK TYPE	RECOMMENDED TEMPERATURE
For storing all types of wines	12°C to 14°C

RECOMMENDED DRINKING TEMPERATURES:

DRINK TYPE	RECOMMENDED TEMPERATURE
Champagne NV, Sparkling	6°C
Champagne Vintage	10°C
Dry White Semillon, Sauvignon Blanc	8°C
Dry White Gewürztraminer, Riesling	10°C
Dry White Chardonnay	10°C
Vintage Chardonnay	14°C
Sweet White Sauternes Monbazillac, Late Harvest ice wine	10°C
Sweet whites vintage Sauternes	14°C
Beaujolais	13°C
Red Pinot Noir	16°C
Vintage Pinot Noir red	18°C
Red Cabernet, Merlot, French, Australian, New Zealand, Chilean, Argentinean, Italian, Spanish, Californian	18°C
Red Grenache, Syrah	16°C



Caple Service
Fourth Way
Avonmouth
Bristol
BS11 8DW

T: 0117 938 1900
E: service@caple.co.uk
www.caple.co.uk