



Fully Integrated In-Column Wine Cabinet Instruction Manual

WC1801



Contact Caple on 0117 938 7420 for spare parts or www.caple.co.uk

CONTENTS

Introduction	3
Warning	3
Environmental Protection	6
Installation Warnings	7
Ambient Temperature	9
Control Panel	10
Using the Shelves	13
How to Replace the Charcoal Filter	14
How to Change the Door Opening	15
Wine Bottle Stacking	16
Installation Dimensions	17
Installing the Fixing Brackets	18
Installing the Furniture Door	19
Care and Maintenance	22
Recommended Temperatures	24
Troubleshooting Guide	25
Caple Contact Details	28

INTRODUCTION

Thank you for buying your new Caple Wine Cabinet.

To ensure that you get the best results from your new purchase, we strongly suggest that you read this instruction manual thoroughly before use. This manual contains installation advice, usage instructions and other important facts about your Caple Wine Cabinet. If treated with care your appliance will give you many years of trouble free use.

WARNINGS

- To prevent damaging the door gasket, make sure the door is fully open when pulling shelves out of the rail compartment.
- The appliance must be positioned so that the plug is accessible. Release the electric cord and move your cabinet to its final location. Do not move your cabinet while loaded with wine as you may distort the body.
- The wine cabinet should be installed in a suitable place in order to avoid touching the compressor.
- After unpacking, make sure that the appliance is in perfect order. If you have any doubt, do not use it and contact your retailer.
- If the supply cord is damaged, it must be replaced by a Caple service agent or a similarly qualified person in order to avoid a hazard.

- This appliance is intended to be used in household and similar applications such as:
 - › Staff kitchen areas in shops, offices and other working environments.
 - › Farm Houses.
 - › By clients in hotels, motels and other residential type environments.
 - › Bed and breakfast type environments.
- This appliance is intended to be used exclusively for the storage of wine.

IMPORTANT

Caple cannot be held liable for any non compliance with these instructions.

ELECTRICAL SHOCK HAZARD

To reduce the risk of fire, electrical shock, or injury when using your appliance, follow these basic precautions:

- Read all instructions before using the wine cabinet.
- DANGER or WARNING: Risk of child entrapment.
- Before you throw away your old wine cabinet: Take off the door, leaving the shelves in place so that children cannot easily climb inside.
- Never allow children to operate, play with, or crawl inside the appliance.
- Never clean appliance parts with flammable fluids. The

fumes can create a fire hazard or explosion.

- Do not store or use gasoline or any other flammable vapours and liquids in the vicinity of this or any other appliance. The fumes can create a fire hazard or explosion.
- The refrigerant of this appliance is R600a, flammable and explosive articles should not be put in or near the cabinet, to avoid the risk of fire or explosion.
- This appliance can be used by children aged from 8 years and above and persons with reduced physical, sensory or mental capabilities or lack of experience and knowledge if they have been given supervision or instruction concerning use of the appliance in a safe way and understand the hazards involved. Children shall not play with the appliance.
- Cleaning and user maintenance shall not be made by children without supervision.
- When positioning the appliance, ensure the supply cord is not trapped or damaged.
- Do not locate multiple portable socket-outlets or portable power supplies at the rear of the appliance.
- Do not use plug adapter.



Symbol ISO 7010 W021

Warning; Risk of fire / flammable materials



ENVIRONMENTAL PROTECTION

Waste electrical products should not be disposed of with household waste. Please recycle where facilities exist. Check with your Local Authority or retailer for recycling advice. This appliance is marked according to the European Directive on Waste Electrical and Electronic Equipment (WEEE).

By ensuring this product is disposed of correctly, you will help prevent potential negative consequences for the environment and human health, which could otherwise be caused by inappropriate waste handling of this product. The symbol on the product indicates that this product may not be treated as household waste. Instead it shall be handed over to the applicable collection point for the recycling of electrical and electronic equipment. Disposal must be carried out in accordance with local environmental regulations for waste disposal.

For more detailed information about treatment, recovery and recycling of this product, please contact your local council, your household waste disposal service or the retailer where you purchased the product.

CE DECLARATIONS OF CONFORMITY **CE**

This appliance has been manufactured to the strictest standards and complies with all applicable legislation, Low Voltage Directive (LVD) and Electromagnetic Compatibility (EMC).

UKCA DECLARATIONS OF CONFORMITY **UK CA**

This appliance has been manufactured to the strictest standards and complies with all applicable legislation.

TECHNICAL FICHE

This appliance conforms to all current and applicable energy regulations. To view the Technical Fiche that supports the energy labelling data, please visit the product page on our website www.caple.co.uk

WARRANTY

Your new appliance is covered by warranty. The warranty card is enclosed - if it is missing, you must provide the following information to your retailer in order to receive a replacement: date of purchase, model and serial number (placed on the inside of the appliance storage drawer). Registration can also be completed online by visiting www.caple.co.uk.

Ensure you keep your warranty card safe, you may need to show it to Caple Service together with proof of purchase.

If you fail to show your warranty card you will incur all repair charges.

Spare parts are only available from Caple Service and spare parts authorised centres.

INSTALLATION WARNINGS

BEFORE USING YOUR WINE CABINET:

- › Remove the exterior and interior packing.
- › **IMPORTANT:** Before connecting the wine cabinet to the power source, let it stand upright for at least 12 hours. This will reduce the possibility of a malfunction in the cooling system from handling during transportation.
- › Before installation, turn the unit off and unplug it from the outlet.
Clean the interior surface with lukewarm water using a soft cloth.

NOTE

To protect the appliance in transit and delivery the door is packed tightly against the cabinet. When first installed this can mean the door seal appears thinner on one side of the door due to compression, this is normal and once out of the box it will relax over a short period of time and the door will return to the normal position. If you wish to speed up the process you can gently warm the seal with a hair dryer on a low temperature setting. This can help relax the seal helping it return to normal thickness a little faster.

INSTALLATION OF YOUR WINE CABINET:

- › The wine cabinet should be installed in a stable and suitably sized kitchen carcass, which has been appropriately levelled and ventilated.
- › To level your wine cabinet, adjust the front levelling leg at the bottom of the cabinet.
- › Ensure it is perfectly level, as this will minimise any vibrations.
- › This appliance uses flammable refrigerant. Never damage the cooling pipework during transportation.
- › Locate the wine cooler away from direct sunlight and sources of heat (ovens, hobs, heaters, radiators, etc.). Never clean appliance parts with flammable fluids as the fumes can create a fire hazard or explosion. When disposing of your appliance, please choose an authorised disposal site.
- › Avoid locating the unit in moist areas.
- › It is fitted with a power cord having an earth wire terminating in a 13amp plug.
- › Ensure the product is correctly ventilated (see page 17).

- › Consult a qualified electrician or service engineer if the earthing instructions are not completely understood.
- › Plug the wine cabinet into an exclusive, properly installed-grounded wall outlet. Do not under any circumstances cut or remove the third (ground) pin from the plug. Any questions concerning power and/or grounding should be directed toward a certified electrician or Caple service.

WARNING

Incorrect earthing can result in the risk of electric shock

ATTENTION

- › Store wine in sealed bottles
- › Do not overload the cabinet
- › Do not open the door unless necessary
- › Do not cover shelves with aluminium foil or any other shelf material which may prevent air circulation
- › Should the wine cabinet be stored without use for long periods it is suggested, after careful cleaning, to leave the door ajar to allow air to circulate inside the cabinet in order to avoid possible formations of condensation, mould or odours.
- › Keep the ventilation openings in the appliance enclosure or in the built-in structure, clear of obstruction
- › Do not use mechanical devices or other means to accelerate the defrosting process, other than those recommended by the manufacturer
- › Do not damage the refrigerant circuit
- › Do not use electrical appliances inside the storage compartments of the appliance, unless they are the type recommended by the manufacturer

AMBIENT TEMPERATURES







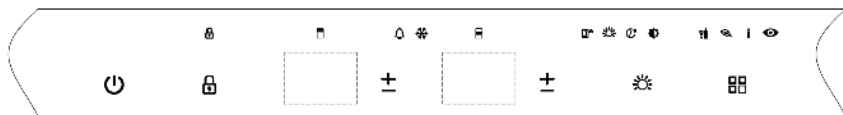

Please use the cabinet within ambient temperatures between 16-32°C, if the ambient temperature is higher or lower than this, it will cause the temperature to fluctuate in the cabinet, possibly preventing it from reaching 5-18°C.

CONTROL PANEL

UPPER AND MIDDLE ZONES







TOUCH CONTROL KEYS AND SYMBOLS



-  To switch the appliance on/off. Press and hold this button for approximately 1 second to turn the appliance on. Press and hold this button for approximately 3 seconds to turn the appliance off.
-  To turn the lock function on/off. Press and hold this button for approximately 3 seconds to activate/deactivate. When activated, the  symbol will illuminate.
-  Press this button to raise the temperature in 1°C increments. Once the temperature reaches the highest temperature value for the upper  or middle zone , it will revert back to its lowest temperature value.
 -  Upper zone = 5-18°C
 -  Middle zone = 5-10°C

Once the required temperature is selected, the LED display will temporarily flash for 5 seconds, then reverts back to the normal display, and the temperature is now set.

NOTE

Press and hold  for 3 seconds, to change the display from °C to °F.

-  This button is used to toggle between the different light functions. When selected, the relevant symbol will illuminate:
 -  The internal light will switch on when the door is opened, and off when the door is closed.
 -  The internal light is continuously on. However after 3 minutes the light will dim.
 -  The internal light will remain on for 10 minutes once the door is closed and then turn off.

-  This symbol indicates the brightness adjuster: Hold the light key  for 3 seconds until  flashes. Then use the \pm keys to adjust the brightness of the internal light.

NOTE:

This product contains a light source of energy efficiency class G.



NOTE:

The light must be replaced by qualified personnel. For instructions on how to replace the light, please contact Caple Service or visit our website.

-  This button is used to toggle between the different operational functions. When selected, the relevant symbol will illuminate:

 **STANDARD MODE**

Select this function to operate the wine cabinet in standard mode.

 **ECO MODE**

An energy saving mode where both the inner light and control panel lights are off (except the  indicator). The LED display is also switched off, until you change the temperature using the \pm and \pm keys, this will be displayed for 5 seconds and then switch off again. The compressor is also delayed 5 minutes in order to save energy.

 **INTELLIGENT MODE**

In intelligent mode, the wine cabinet will adjust the fan speed according to the ambient temperature. This will reduce noise levels and save energy.

 **DEMO MODE**

When DEMO mode is selected, the compressor and PTC heater will be disabled, and the fan input voltage reduces to 9V. The HI/LO temperature alarm is also disabled during DEMO mode.

-  The cooling symbol will illuminate to show when the wine cabinet is currently cooling.

-  The alarm symbol will illuminate to show the alarm is on. This will activate when either the door has been left open for a long period of time, or the temperature has fluctuated too high or low (HI or LO will also show in display to confirm this).

LOWER ZONE CONTROL PANEL

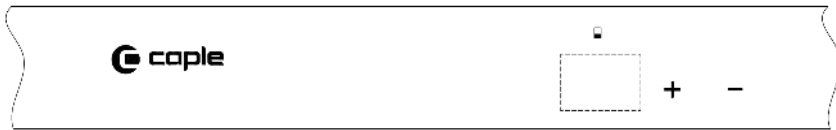

Press this " + " button to increase temperature by 1°C

Press this " - " button to decrease the temperature by 1°C

■ Lower zone: 10-18°C

USING THE SHELVES

To prevent damaging the door gasket, make sure to have the door opened fully when pulling shelves out of the rail compartment.

REMOVING THE SHELVES

1. Fully extend the shelf you wish to remove
2. Lift the front of the shelf up to remove from the front clips
3. Holding onto the shelf runner, push the shelf in and then pull up at the back to release from the rear clips.

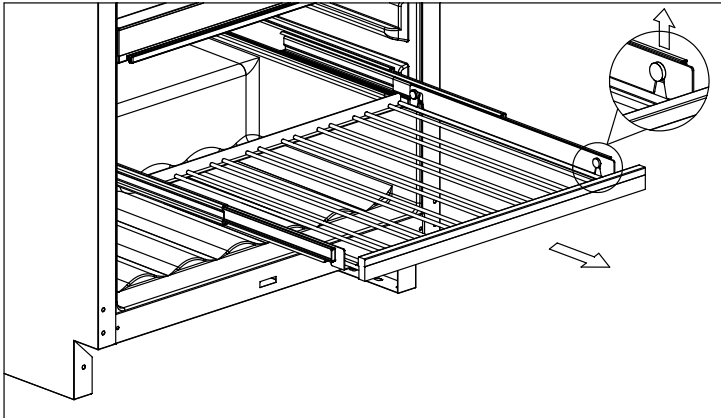

Glass shelves are available if you wish to store cans or smaller bottles such as beer in your wine cabinet. These can be purchased directly from www.caple.co.uk.

HOW TO REPLACE THE CHARCOAL FILTER

The charcoal filters are located in the top right corner of each zone. To replace the filters, follow the below steps:

1. Open the door and remove the top 2 shelves (see removing the shelves).
2. Turn the filter as per Fig A.
3. As per Fig B, the filter should line up with the notches as shown.
4. Pull the filter out (Fig C).
5. Insert replacement filter and twist as per Fig A to lock into position.
6. Re-install the shelves

NOTE:

The charcoal filter should be replaced every 3-6 months depending on the unit's exposure level to odour.

Visit www.caple.co.uk to purchase the replacement charcoal filters.

FIG. A - LOCKED

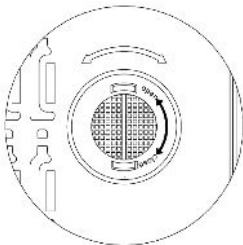

FIG. B - UNLOCKED

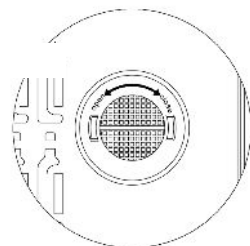
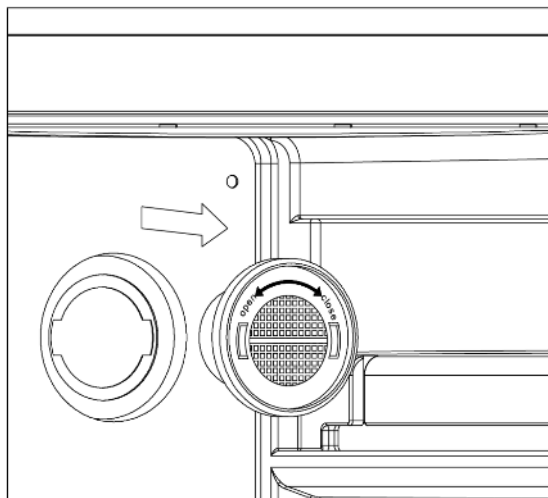

FIG. C



HOW TO CHANGE THE DOOR OPENING

This appliance has reversible doors but is delivered with a right hand hinged door.

Should you wish to reverse the hinge on your unit, follow the directions below:

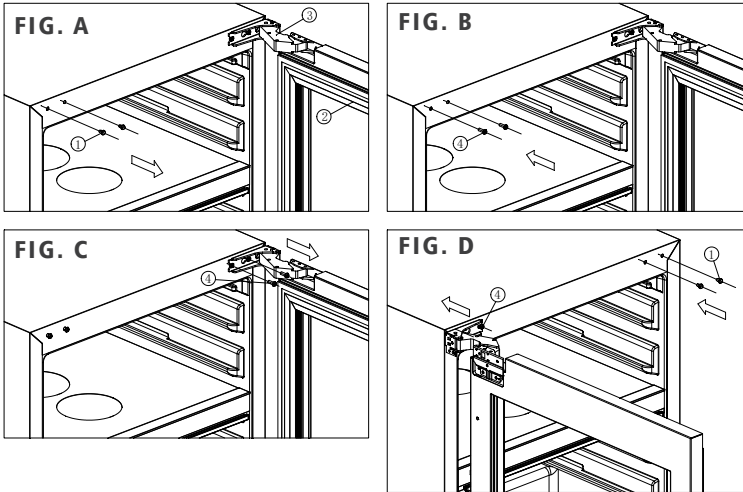

- | | |
|----------------------|-----------|
| 1. Decorative covers | 3. Hinge |
| 2. Door | 4. Screws |

1. Open the door and remove the decorative covers(1) on the left hand side as shown in Fig A.
2. Fix the screws into these positions as per Fig B, but do not fasten the screws.
3. Remove all screws from both the upper and lower hinge, and then remove the door.
4. Rotate the door 180 degrees, and place the hinges into the screws fixed in Fig B. Once slotted onto these screws, tighten the screws to secure the hinges (Fig D).
5. Place the decorative covers in the right hand side screw holes as shown in Fig D.

WINE BOTTLE STACKING

Champagne bottle on standard shelf:

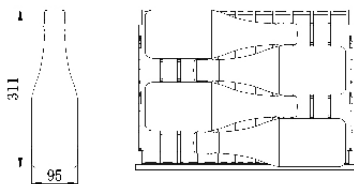

Bordeaux bottle on standard shelf:

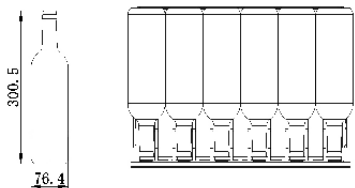

Bordeaux bottle on display shelf:

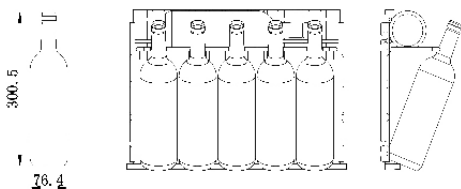

Bordeaux: total 70 bottles(max)
or
Bordeaux: total 22 bottles + Champagne: total 32 bottles (max)

wine cooler

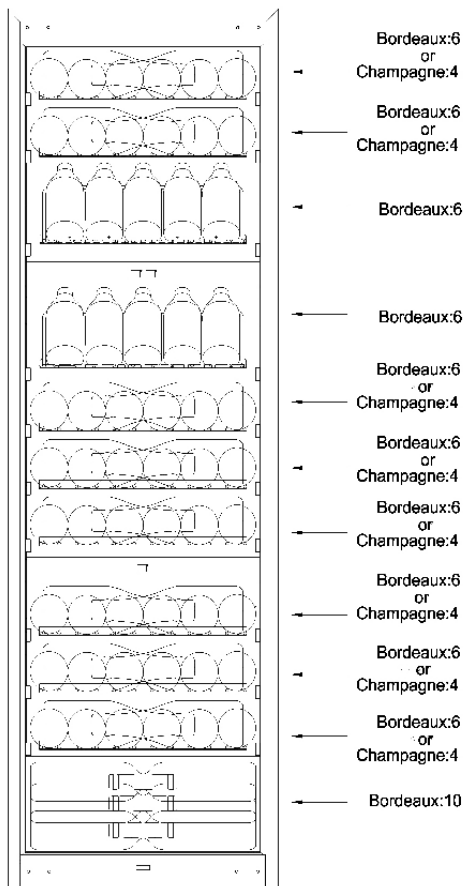

Stores max. 70 Bordeaux style bottles 750ml.

NOTE:

If you wish to store other style bottles i.e. champagne, the maximum storage capacity will be less than as shown above. Shelves may also need to be removed to allow more bottles to be stored.

INSTALLATION DIMENSIONS

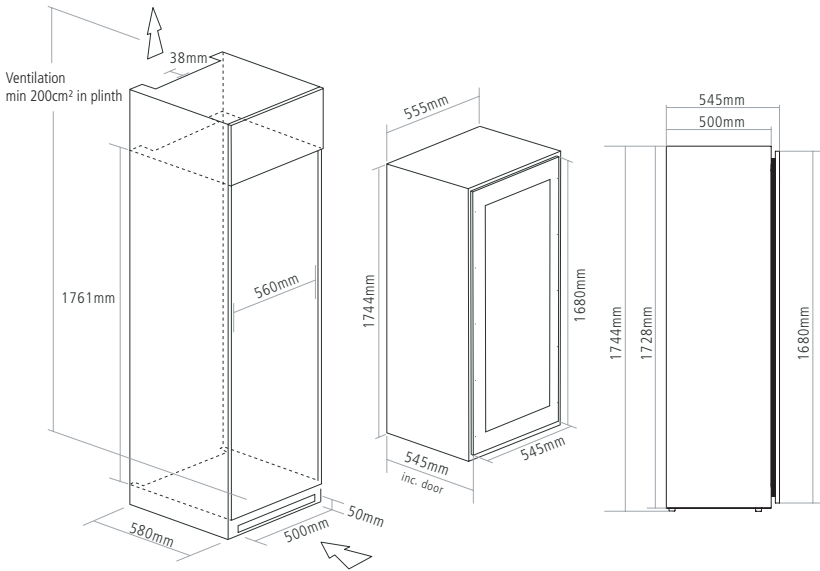

VENTILATION:

- › The ventilated cross section must be at least 200cm² and the wine cabinet shall be ventilated from the kitchen plinth.
- › The back panel of the carcass the appliance is installed into shall be removed.
- › Where the decorative grill is used it must be noted that the total area of the grill opening corresponding to the ventilation cross section shall not be less than 200cm².

NOTE:

It is important that the furniture cabinet is completely square and the base is level. If it is not level the product may appear to lean, this is not a fault of the product and the installation must be corrected.

Once the product is correctly located in the cabinet, it is important that the feet are adjusted to level the product.

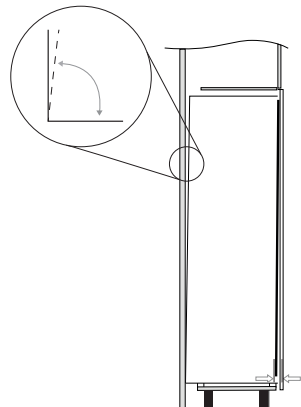

INSTALLING THE FIXING BRACKETS

The wine cabinet comes with two fixing brackets(2) to secure the appliance to the kitchen carcass. There are also screw holes included in the door hinges that allow you to secure the wine cabinet to the opposite side of the carcass (Fig. B & Fig. D).

These brackets will keep the wine cabinet secure and help prevent it moving when in use.

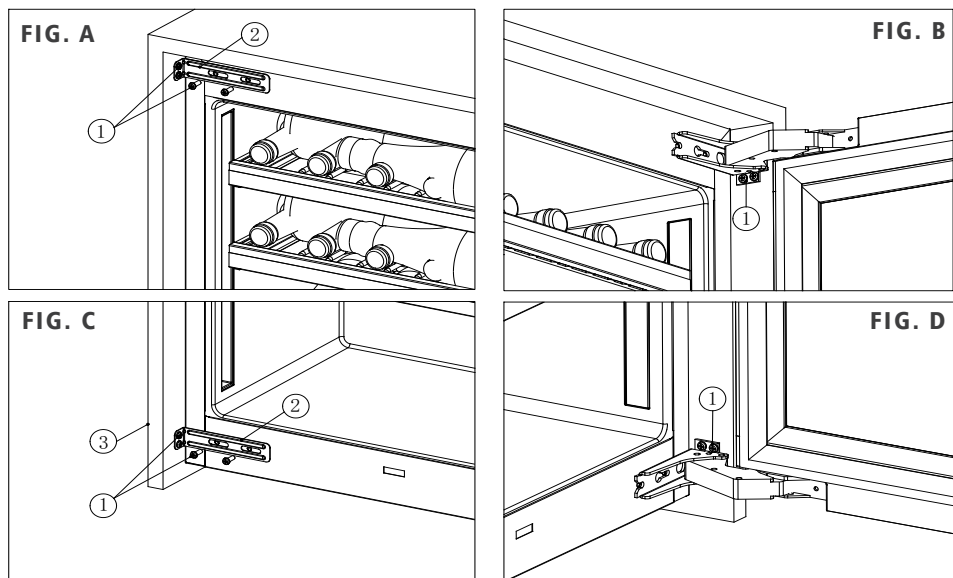

1. Screw

2. Fixing bracket

3. Kitchen cabinet

- › As per Fig. A, line the fixing bracket up with the two holes at the top of the wine cabinet, and using the screws provided, secure the bracket onto the appliance. Once secure, fix the other side of the bracket into the kitchen cabinet using the screws provided.
- › On the hinged side of the appliance, the hinges include screw holes to secure the appliance to the opposite side of the kitchen cabinet. Locate these holes as per Fig. B, and using the screws provided, screw tightly into the kitchen cabinet.
- › Repeat this process for the bottom of the cabinet as shown in Fig. C & Fig. D.

INSTALLING THE FURNITURE DOOR

You will need to install a furniture door frame to the front of the wine cabinet once the wine cabinet has been installed.

The furniture door frame can be custom made to line up with your other furniture doors in the kitchen. The door must be finished on both sides in order to prevent warping. In some installations the door panel may be visible through the glass when the door is open. See below for wine cabinet door dimensions, and also an example of a furniture door size.

NOTE:

The door panel must not weigh more than 20kg.

NOTE:

The door thickness must not exceed 22mm. If a thicker door is used, the door may make contact with the adjacent furniture door when opened.

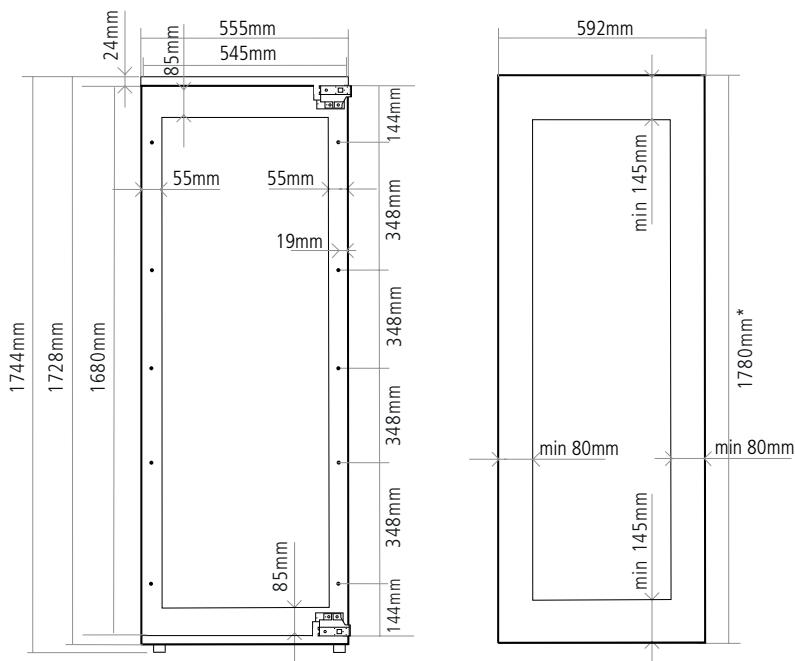

* The height of the furniture door will need to be adjusted to ensure it lines up with the other kitchen cabinet doors, therefore these dimensions will vary.

NOTE:

The furniture door can extend beyond the appliance door, however you must ensure a gap of at least 75mm must be left from the bottom of the furniture door to the floor to allow for sufficient ventilation.

NOTE:

If a handle is required, please ensure this is installed in an appropriate position before the furniture door is installed.

1. Fully open door.
2. Starting at the corner, pull the gasket away from the door (see Fig. A - pg 21).
3. Continue to pull the gasket free from the gasket channel.
4. Upon removal, lay gasket down on a flat surface.
5. Secure the furniture door panel to the appliance door using clamps (see Fig. B - pg 21).
6. Using a 3mm drill bit, drill 10 pilot holes into the wood panel 12mm deep using the holes in the door frame as a guide.

NOTE:

It is important to ensure that all drilled holes are drilled to the correct depth in order to avoid splits in the wood when hardwood is installed. You must also take care not to drill all the way through the door.

7. Locate 10 of the M4x34mm screws provided with your unit.
8. Using a Phillips screwdriver, place one screw into each of the 10 pilot holes and screw into the door (see Fig. C - pg 21). Be careful not to over tighten screws. Ensure the screws sit flush against the bottom of the channel. Remove clamps from door.

NOTE:

If panel requires additional adjustment after removing clamps, slightly loosen each screw and adjust panel as necessary. Tighten screws upon completion.

9. Starting at the corners, re-install the gasket into the gasket channel in the frame, by pushing firmly into place. Make sure the gasket is fully seated into the channel.

FIG. A

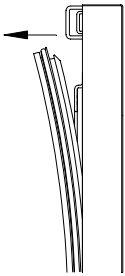

FIG. B

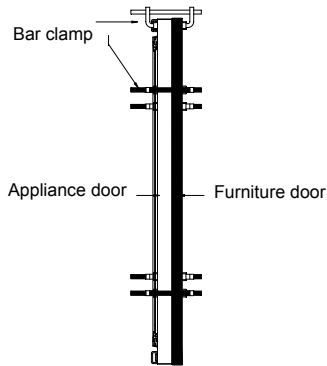
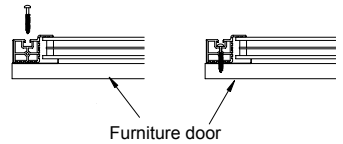

FIG. C



CARE AND MAINTENANCE

CLEANING YOUR WINE CABINET

- › Turn off the power, unplug the appliance, and remove all items including the shelves.
- › Wash the inside surfaces with a warm water and baking soda solution. The solution should be about 2 tablespoons of baking soda to 2 pints of water.
- › Wash the shelves with a mild detergent solution.
- › Wring excess water out of the sponge or cloth when cleaning the area of the controls, or any electrical parts.
- › Wash the outside cabinet with warm water and mild liquid detergent. Rinse well and wipe dry with a clean soft cloth.

NOTE:

Please take care when cleaning the plinth grille as this may have sharp edges.

TEMPERATURE RECOLLECTION FUNCTION

In the event of a power interruption, the wine cooler will recall the previous temperature settings once the power is recovered.

TEMPERATURE ALARM

If the internal temperature is higher than 23°C, the display will show “HI” on the appropriate zone, and the alarm will sound after one hour continuously.

If the internal temperature is lower than 0°C, the display will show “LO” on the appropriate zone, and the alarm will sound. The malfunction indicator light will also be on at the same time to warn the consumer.

Check the troubleshooting section to see why the temperature could be fluctuating, and if necessary, contact Caple service.

OPEN DOOR ALARM

If you forget to close the door or the door is not closed completely, the alarm will sound after 5 minutes. Ensure the door is closed properly to avoid this alarm.

NOTE:

If the unit is unplugged, power lost, or turned off, you must wait 3 to 5 minutes before restarting the unit. If you attempt to restart before this time delay, the Wine Cooler may not start.

When you use the wine cooler for the first time or restart the wine cooler after having been shut off for a long time, there could be a few degrees variance between the temperature you select and the one indicated on the LED display. This is normal and it is due to the length of the activation time. Once the wine cooler is running for a few hours everything will be back to normal.

VACATION TIME

Short Vacations: Leave the Wine Cooler operating during vacations of less than three weeks.

Long Vacations: If the appliance will not be used for several months, remove all items and turn off the appliance. Clean and dry the interior thoroughly. To prevent odour and mould growth, leave the door open slightly; blocking it open if necessary.

MOVING YOUR WINE COOLER

- › Remove all items.
- › Securely tape down all loose items (shelves) inside your appliance.
- › Turn the adjustable leg up to the base to avoid damage.
- › Tape the door shut.
- › Be sure the appliance stays secure in the upright position during transportation. Also protect outside of appliance with a blanket, or similar item.

DEFROSTING/CONDENSATION

Your wine cabinet is designed with an "Auto-cycle" defrost system. When the cooling cycle is OFF, the refrigerated surface of the wine cabinet (interior rear wall) defrosts automatically. The defrosted water is channelled into a drain pan which is located at the back of the cabinet next to the compressor from where it evaporates.

CLOSING THE DOOR

Close the door with care as slamming the door puts excess stress on the appliance and can cause the door to bounce open slightly. If this is not noticed, it can cause excess moisture to build up in the cabinet which in extreme cases can lead to the evaporation tray overflowing.

RECOMMENDED TEMPERATURES

RECOMMENDED STORAGE TEMPERATURES:

For storing all types of wines 12°C to 14°C

RECOMMENDED DRINKING TEMPERATURES:

DRINK TYPE	RECOMMENDED TEMPERATURE
For storing all types of wines	12°C to 14°C
Champagne NV, Sparkling	6°C
Champagne Vintage	10°C
Dry White Semillon, Sauvignon Blanc	8°C
Dry White Gewürztraminer, Riesling	10°C
Dry White Chardonnay	10°C
Vintage Chardonnay	14°C
Sweet White Sauternes Monbazillac, Late Harvest ice wine	10°C
Sweet whites vintage Sauternes	14°C
Beaujolais	13°C
Red Pinot Noir	16°C
Vintage Pinot Noir red	18°C
Red Cabernet, Merlot, French, Australian, New Zealand, Chilean, Argentinean, Italian, Spanish, Californian	18°C
Red Grenache, Syrah	16°C

TROUBLESHOOTING GUIDE

PROBLEM	POSSIBLE CAUSE
The wine cabinet does not operate	<p>Not plugged in. The appliance is turned off. The circuit breaker tripped or a blown fuse.</p>
The wine cabinet is not cold enough	<p>Check the temperature control setting. External environment may require a higher setting. The door is opened too often. The door is not closed completely. The door gasket does not seal properly.</p>
The compressor turns on and off frequently	<p>The room temperature is hotter than normal. A large amount of contents has been added to the wine cabinet. The door is opened too often. The door is not closed completely. The temperature control is not set correctly. The door gasket does not seal properly.</p>
The light does not work	<p>The circuit breaker tripped or a blown fuse. The bulb has burned out. The light button is "OFF".</p>
Vibrations	<p>Check that the appliance is even</p>
The Wine cabinet seems to make too much noise.	<p>The rattling noise may come from the flow of the refrigerant, which is normal. As each cycle ends, you may hear gurgling sounds caused by the flow of refrigerant in your wine cabinet. Contraction and expansion of the inside walls may cause popping and crackling noises. The wine cabinet is not level.</p>
The door will not close properly	<p>The wine cabinet is not level. The gasket is dirty. The shelves are out of position.</p>

If the above table has not solved the problem please contact Caple Service by phone on **0117 938 7420** or by email **service@caple.co.uk**

SPARE PARTS AVAILABILITY

The original spare parts for some specific components are available for a minimum of 7 or 10 years, based on the type of component, from the placing on the market of the last unit of the model.

For more info and to order spares, please contact Caple service or visit our website www.caple.co.uk



Caple Service
Fourth Way
Avonmouth
Bristol
BS11 8DW

T: 0117 938 1900
E: service@caple.co.uk
www.caple.co.uk