



## **KITCHEN + BEDROOM.**

---

Product Guide 2024



## HOUSING

**002**

The devil is in the details, so, to assist with the design process and ensure there is no room for error, we have visualised and categorised each kitchen and bedroom component by range to plan every detail with ease.



## IN-FRAME

**010**

A premium range of beautifully crafted kitchen furniture, effortlessly combining traditional looks with a subtle contemporary touch. Exceptionally high quality and distinctive design means our In-Frame kitchens will stand the test of time.



## VERSE HANDLELESS

**018**

The uninterrupted, smooth lines of Verse Handleless give this range a premium and contemporary look. Verse Handleless utilises an integrated aluminium rail system that creates a space between cabinets to allow opening and closing of doors and drawers.



## SHAKER

**036**

If your style is traditionally English, contemporary country, or naturally rustic, have a look at the kitchens in our Shaker collection. Caple's shaker kitchens are characterised by elegant details, rich woods, and subtle colours.



## J-HANDLE

**072**

Experience a kitchen that exudes modern elegance and sophistication. The cabinets, with their integrated 'J' style handles, not only add a touch of contemporary charm but also ensure uncluttered lines that flow throughout your space.



## SLAB

**082**

Transform your space with our Slab kitchen collection - a modern embodiment of simplicity and style. The sleek, plain slab doors seamlessly integrate into a contemporary setting, offering an understated charm.



## BEDROOMS

**107**

Embrace the moment to wind down, get comfortable, and sink into a peaceful slumber. With our bedroom range, your private retreat is thoroughly designed to maintain a clutter-free environment, ensuring the ideal ambience for your relaxation.



## HANDLES

**122**

Will it be contemporary linear stainless steel, or a set of traditional pewter knobs? It's amazing how these small [and essential] items can completely transform the finish of your kitchen.



# Kitchen + Bedroom Guide.

Your dream kitchen is about to become a reality. But the devil is in the details. So, to assist with the design process and ensure there is no room for error, we have visualised and categorised each kitchen component by range to plan every detail with ease.

Use this guide along with our Kitchen + Bedroom Furniture Collection to assist you with each decision and take the guesswork out of the process. Within each range, you will find a price group, the components available and whether special sizes are available to create a truly bespoke kitchen.

Relax and unwind, knowing your bedroom design is in safe hands. Browse the collection of components and create your stress-free sanctuary. Say goodbye to clutter and add accessories for an organised, accessible wardrobe.





# Kitchen Housing Units. STANDARD LAY-ON.

## 1970MM TALL HOUSINGS

Note: the guide height for Wall unit installation is 2120mm

<b>RTOHS60</b> Single Oven	<b>RTOHSD60</b> Single Oven	<b>RTOHSC60</b> Single Oven & Compact	<b>RTOHD60</b> Double Oven	<b>RTOHDD60</b> Double Oven	<b>RTOHC60</b> Compact Appliance <small>*Filler can be removed or cut to fit</small>	<b>RTFF1/60</b> <b>RTFF1U/60*</b> Fridge and Freezer <small>*Door-on-door appliance</small>	<b>TFF3/60</b> <b>TFF3U/60*</b> Fridge and Freezer <small>*Door-on-door appliance</small>	<b>TFF4/60*</b> <b>TFF4U/60**</b> Fridge and Freezer <small>*Doors supplied undrilled **Door-on-door appliance</small>	<b>RTL30/40/50/60</b> Larder <b>RTLID30/40/50/60</b> Inner Drawer Larder

<b>TLU80/10</b> Larder	<b>TDLU80/10</b> Drawer Larder	<b>RTLUSD50/60</b> Single Door Larder	<b>RTISPOL30</b> <b>RTKPOL30</b> Pull-Out Larder	<b>TCLU98</b> Corner Larder [985x985] <small>Not Metz or Saraya</small>	<b>TDWIL1144</b> Diagonal Walk-in Larder [1144x1144]	<b>TDCLU1003</b> Diagonal Larder [1003x1003]

## SPLYED UNITS

<b>RABA360</b> [400 Door] Universal	<b>RAWU360</b> [400 Door] Universal

## 1250MM MIDI HOUSINGS

<b>RMA160</b> Larder	<b>RMLU60</b> 3 Shelf Larder	<b>RMD060</b> Double Oven	<b>RMOHS60</b> Single Oven

# Kitchen Housing Units.

## STANDARD LAY-ON.

### 2150MM TALL HOUSINGS

Note: the guide height for wall unit installation is 2300mm

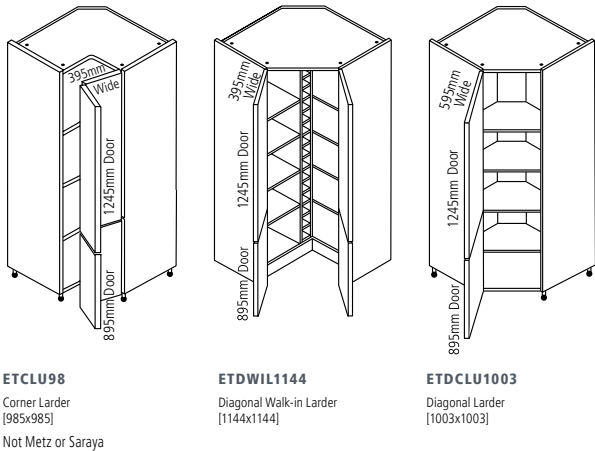
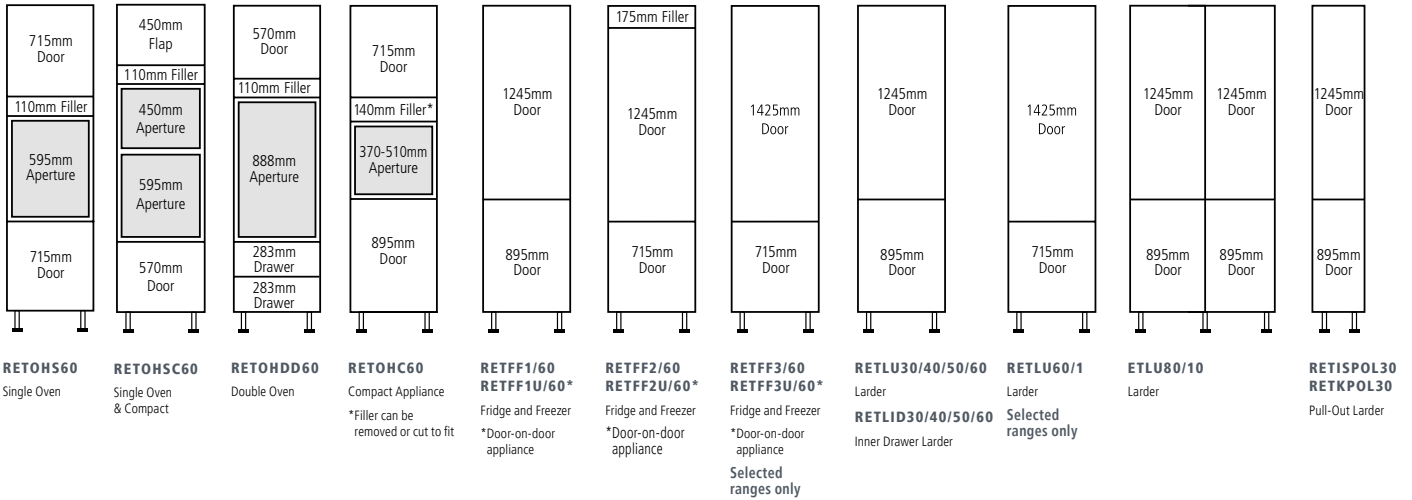

### HINTS ON CORNER PLANNING

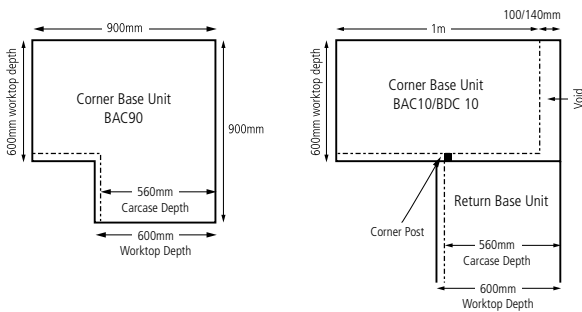

We recommend that only one working drawer should be used, with the other unit adopting either a dummy drawer front [without handle fitted] or a full height door.

**PLEASE NOTE:** Corner post widths vary from range to range, this should be considered in both design and installation.

- › All Caple kitchens are supplied with Blum Antaro full extension soft close drawer boxes and Hettich Sensys integrated soft close hinges [except integrated fridge/freezer housings] as standard
- › All horizontal wall units and tall housings which incorporate a lift-up door have Blum Aventos HK-S mechanisms
- › All standard corner bases are supplied with a blanking panel and corner post
- › All glazed units are supplied with glass shelves
- › All dimensions listed are in mm
- › Floor standing unit heights exclude plinth

# Kitchen Housing Units. VERSE HANDLESS.

## 1970MM TALL HOUSINGS

Note: the guide height for Wall unit installation is 2120mm

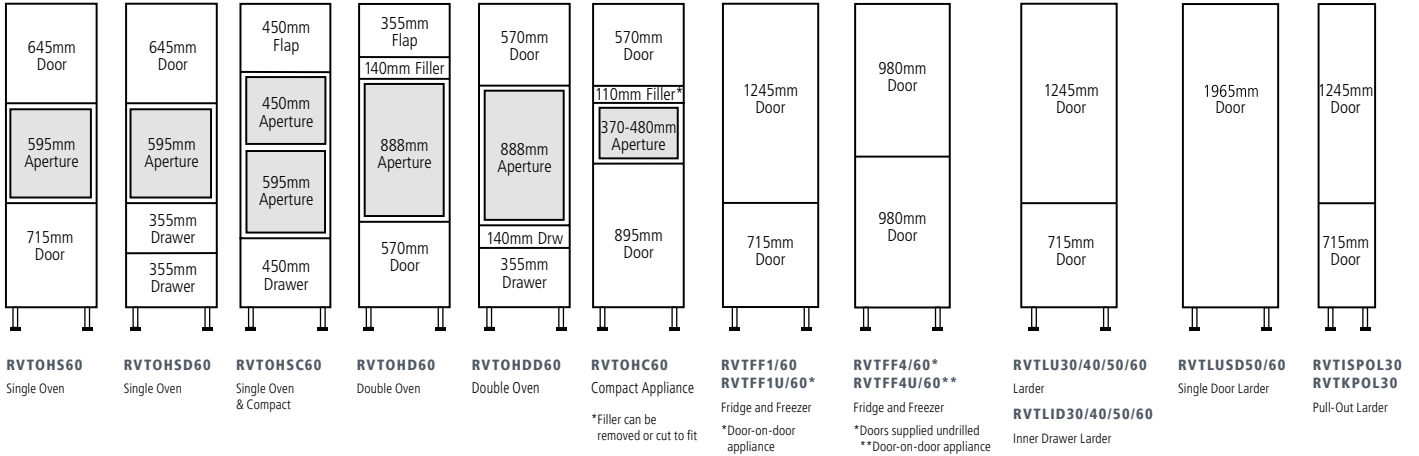

## 2150MM TALL HOUSINGS

Note: the guide height for Wall unit installation is 2300mm

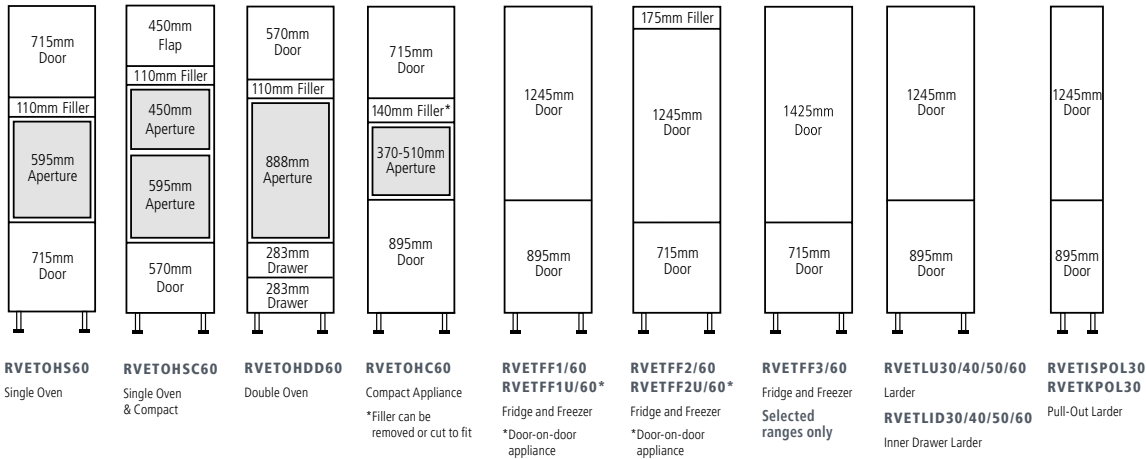

## 1250MM MIDI HOUSINGS

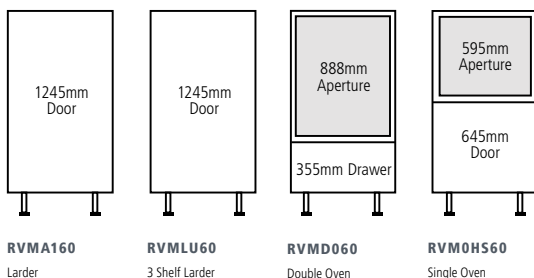

# In-Frame Housing Units. HARPTREE + SUTTON.

## TALL HOUSINGS

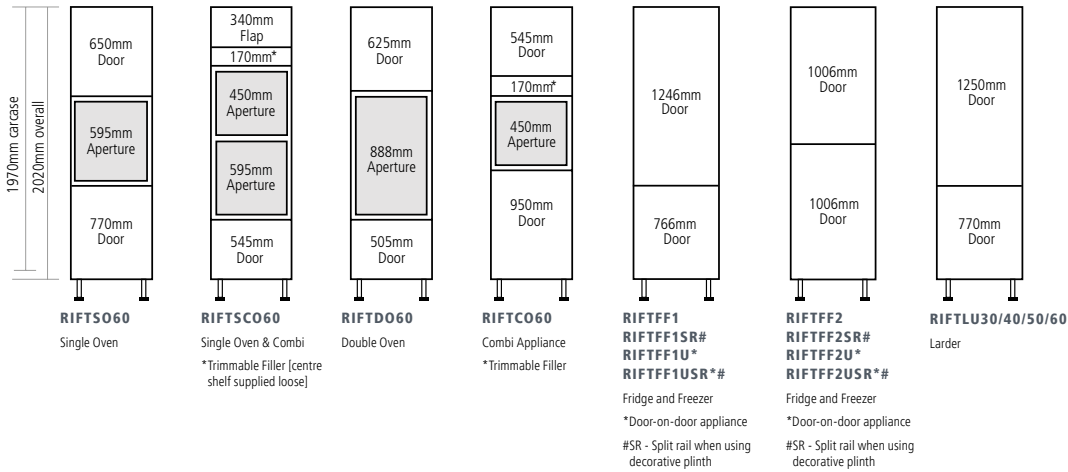

## TALL HOUSINGS

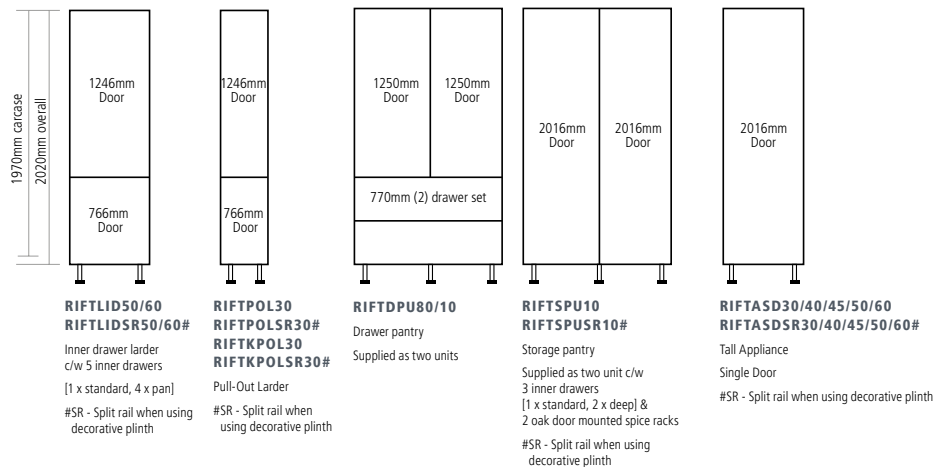

## EXTRA TALL HOUSINGS

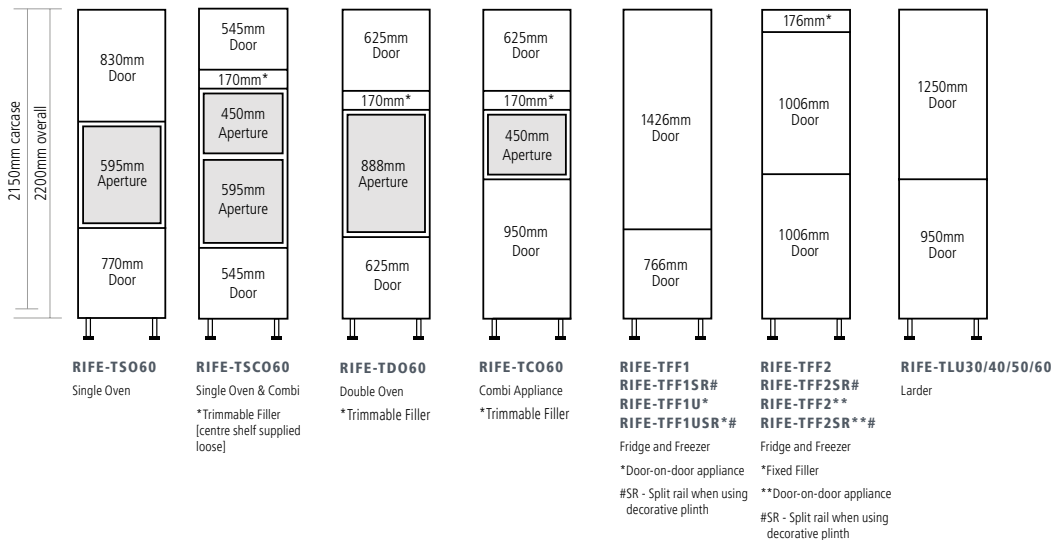

- » All Caple in-frame kitchens are supplied with oak dove-tailed drawer boxes on Blum Movento full extension soft close runners and Blum fully integrated soft close hinges [except integrated fridge/freezer housings] as standard
- » All horizontal wall units and tall housings which incorporate a lift-up door have Blum Aventos HK-XS mechanisms
- » All illustrations are a guide only
- » All standard corner bases are supplied with a blanking panel and a pre-formed 60x60 corner post
- » All glazed units are supplied with glass shelves
- » Floor standing unit heights exclude plinth
- » Special sizes available – [not available in corner door arrangements] – contact us for further information
- » All 1000mm glazed wall units [H:720/900 high] and 800,900,1000mm wall units [H:900mm] are supplied as a two frame system



# In-Frame Housing Units. WINFORD.

## TALL HOUSINGS

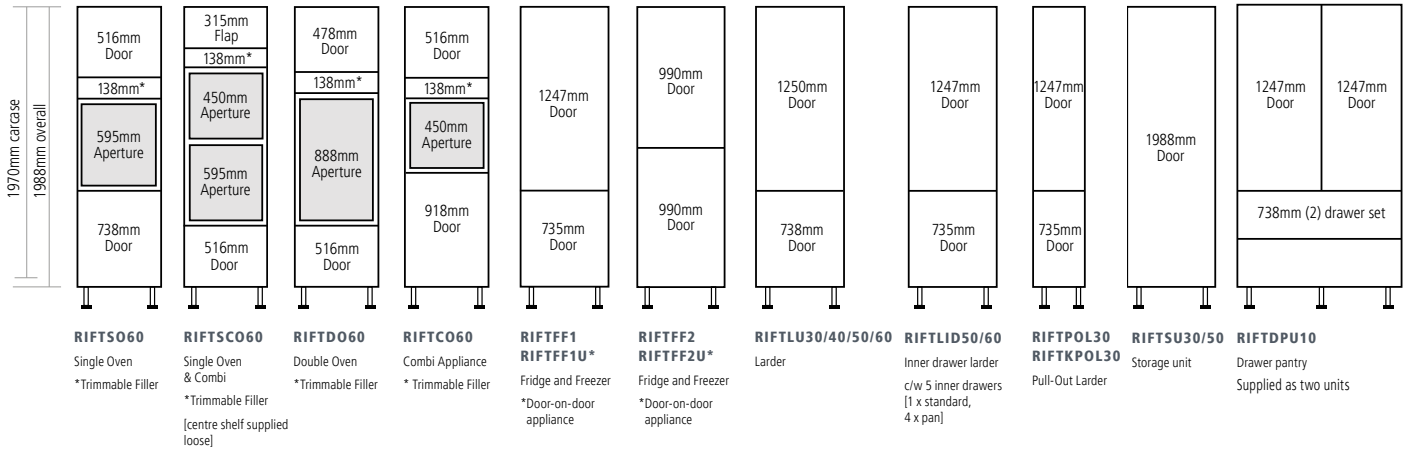

## EXTRA TALL HOUSINGS

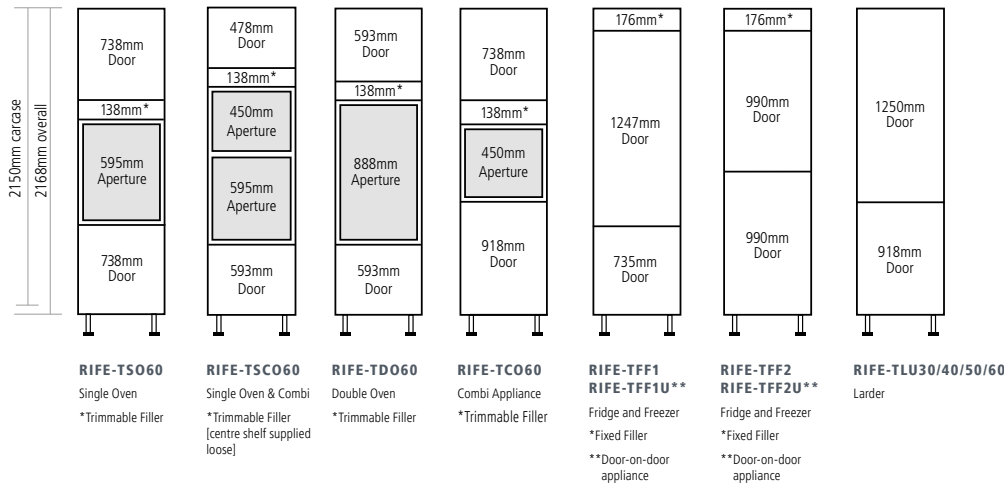

- › All Caple in-frame kitchens are supplied with oak dove-tailed drawer boxes on Blum Movento full extension soft close runners and Blum fully integrated soft close hinges [except integrated fridge/freezer housings] as standard
- › All horizontal wall units and tall housings which incorporate a lift-up door have Blum Aventos HK-XS mechanisms
- › All standard corner bases are supplied with a blanking panel and a pre-formed 60x60 corner post
- › All glazed units are supplied with glass shelves
- › Floor standing unit heights exclude plinth
- › Special sizes available – [not available in corner door, feature door or integrated appliance door sets] – contact us for further information
- › All 1000mm glazed wall units [H:720/900 high] and 800,900,1000mm wall units [H:900mm] are supplied as a two frame system
- › Curved return base units have a fixed frame system [appliance door set]

# Bedroom Housing Units.

## END ELEVATIONS

TALL ROBE

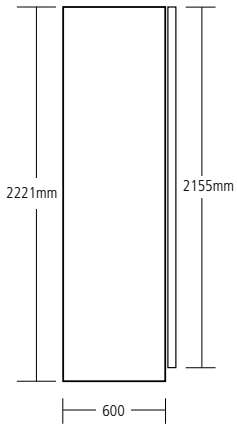

STANDARD ROBE

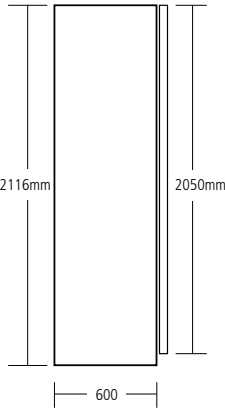

BRIDGING UNIT

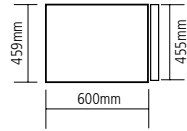

TALL BOY CHEST  
4 DRAWERS

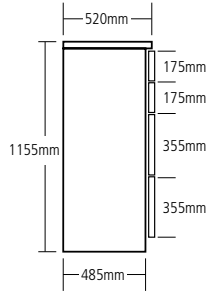

TALL BOY CHEST  
3 DRAWERS

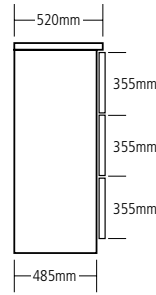

TALL BOY CHEST  
6 DRAWERS

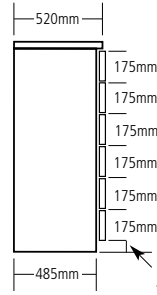

SCRIBE PLINTH  
TO SUIT

WINDOW SEAT  
DRAWER

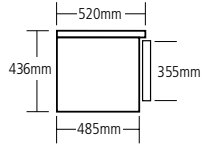

WINDOW SEAT  
2 DRAWERS

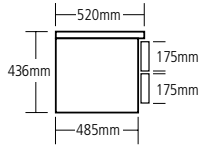

FLOATING BEDSIDE CABINET  
DRAWER

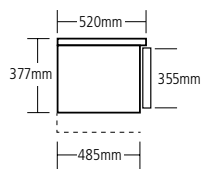

STANDARD CABINET

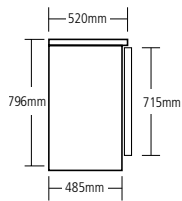

DRAWERLINE CABINET

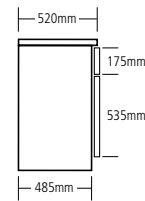

DRAWER CHEST  
2 DRAWERS

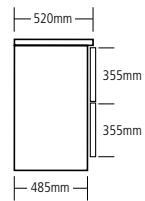

DRAWER CHEST  
3 DRAWERS

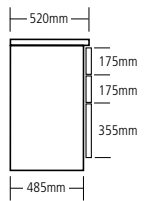

DRAWER CHEST  
4 DRAWERS

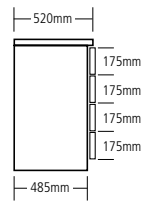

BEDSIDE CABINET

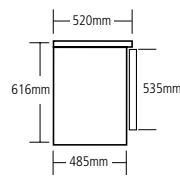

BEDSIDE DRAWER CHEST  
2 DRAWERS

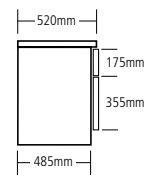

BEDSIDE DRAWER CHEST  
3 DRAWERS

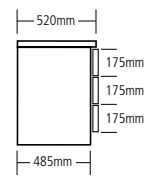

## CORNER SITUATIONS

1000MM CORNER ROBE

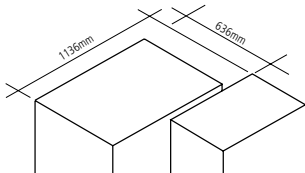

900MM CORNER ROBE

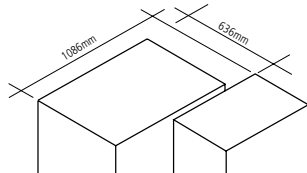

800MM CORNER ROBE

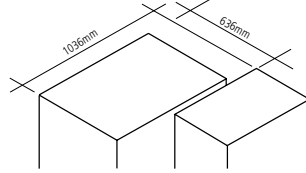

600MM CORNER ROBE

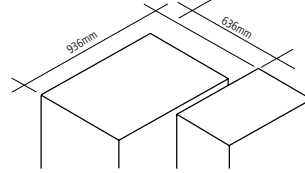

DIAGONAL CORNER ROBE

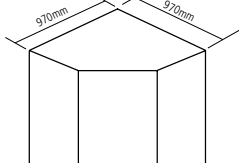

1000MM STABLE ROBE

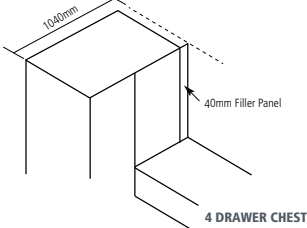

300MM ANGLED ROBE WITH 400MM DOOR. [STATE LH OR RH]

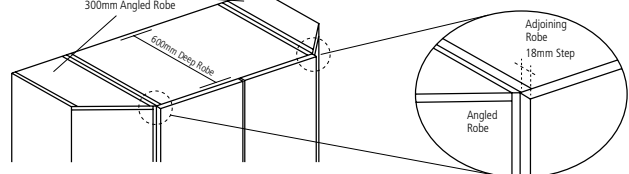









# In-Frame.

A premium range of beautifully crafted kitchen furniture, effortlessly combining traditional looks with a subtle contemporary touch.

Exceptionally high quality and distinctive design means our In-Frame kitchens will stand the test of time.

IN-FRAME

PRICE GROUP 9, 11 + 12

# HARPTREE

Special sizes available  
contact us for further information

Primed [PG9]

Colour Options [PG11]: Auburn, Black, Bone, Dusty Rose, Cashmere, Coal, Cotton, Fern, Forest, Mink, Mist, Moss, Navy, Putty, Riptide, Sea Salt, Smoke, Space, Thyme, Twilight.

Bespoke Colour Option [PG12]



## HI-LINE BASE

Pull-Out		Pull-Out Split Rail		Curved Door		Curved Return [300mm deep]		Double Curved Door		Shallow Base [300mm deep]			
H:770mm CODE	WIDTH	H:766mm CODE	WIDTH	H:770mm CODE	WIDTH	H:770mm CODE	WIDTH	H:770mm CODE	WIDTH	H:770mm CODE	WIDTH	H:770mm CODE	WIDTH
RIFBA30	300	RIFBISPO15	150	RIFCDBA30	300x300	RIFCRBA26	260	RIFCDBA60	600x600	RIFBSU30	300	RIFBSU60	600
RIFBA35	350	RIFBISPOS15	150	Standard Mechanism inc.						RIFBSU35	350	RIFBSU80#	800
RIFBA40	400	RIFBKPO15	150	Kesseböhmer Mechanism inc.						RIFBSU40	400	RIFBSU90#	900
RIFBA45	450	RIFBA10#	1000	Kesseböhmer Mechanism & towel rail inc.						RIFBSU45	450	RIFBSU10#	1000
RIFBA50	500	RIFBKTP015	150	Kesseböhmer Mechanism & towel rail inc.						RIFBSU50	500	# 2 x Doors	

## HI-LINE BASE

Chopping Board & Tray Set		Spice Drawer Set		Tray Set	
H:770mm CODE	WIDTH	H:770mm CODE	WIDTH	H:770mm CODE	WIDTH
IFCBTS207	200	IFSDS207	200	IFTS207	200

## HI-LINE CORNER BASE

'L' Shaped	
H:770mm CODE	WIDTH
RIFBAC830	800/300
RIFBAC80	800/400
RIFBAC845	800/450
RIFBAC850	800/500
RIFBAC860	800/600
RIFBAC940	900/400
RIFBAC945	900/450
RIFBAC950	900/500
RIFBAC960	900/600
RIFBAC140	1000/400
RIFBAC145	1000/450
RIFBAC10	1000/500
RIFBAC160	1000/600
RIFBAC12	1200/600

Inc. Corner Post & Blanking Panel

## DRAWERLINE BASE

'L' Shaped		Ancillary Chest Base		Open End Island Unit	
H:770mm CODE	WIDTH	H:770mm CODE	WIDTH	H:870mm CODE	WIDTH
IFBAC90	900x900	RIFBD30	300	OEIU9*	910x500
Bi-fold hinge system Flatpack		RIFBD40	400	OEIU12*	1170x500
		RIFBD45	450	Includes drawer box and runners	
		RIFBD50	500	*Not available as a Primed Finish	
		RIFBD60	600	Ready assembled unit	
		RIFBD80#	800		
		RIFBD90#	900		
		RIFBD10#	1000		
		# 2 x Doors			

## BELFAST SINK BASE

## DRAWERLINE CORNER BASE

## BUILT UNDER

## 2 DRAWER BASE

## Slab Drawer Fronts

## Storage Crates

## 3 DRAWER BASE

## Slab Drawer Fronts

H:770mm CODE	WXH	H:770mm CODE	WIDTH	H:770mm CODE	WIDTH	H:770mm CODE	WIDTH	H:770mm CODE	WIDTH	H:770mm CODE	WIDTH	H:770mm CODE	WIDTH
RIFBSU6045	600x505	RIFBDC830	800/300	RIFBDC950	900/500	RIFBU060	600	RIFBD250	500	RIFBD280SL	800	RIFCD250	500
To suit a sink height of 260-265mm		RIFBDC80	800/400	RIFBDC960	900/600			RIFBD260	600	RIFBD290SL	900	2 x deep drawers	
		RIFBDC845	800/450	RIFBDC140	1000/400			RIFBD280	800	RIFBD210SL	1000	Oak drawers	
		RIFBSU6049	600x545	RIFBDC850	800/500			RIFBD290	900			1 x standard	
		RIFBSU8049#	800x545	RIFBDC860	800/600			RIFBD210	1000			2 x deep drawers	
To suit a sink height of 220-225mm		RIFBDC80#	800/400	RIFBDC10	1000/500							1 x standard	
# 2 x Doors		RIFBDC940	900/400	RIFBDC160	1000/600							2 x deep drawers	
		RIFBDC945	900/450	RIFBDC12	1200/600								

Inc. Corner Post & Blanking Panel

## 4 DRAWER BASE

## MEDIUM WALL

4 Drawer Base		Glazed		'L' Shaped Corner		Standard Corner		Curved Door		Tall Wall		Glazed		'L' Shaped Corner	
H:770mm CODE	WIDTH	H:770mm CODE	WIDTH	H:770mm CODE	WIDTH	H:770mm CODE	WIDTH	H:770mm CODE	WIDTH	H:950mm CODE	WIDTH	H:950mm CODE	WIDTH	H:950mm CODE	WIDTH
RIFBD430	300	RIFWU30-7	300	RIFWG50-7	500	RIFCWL60-7	600x600	RIFWUC60-7	600	RIFCWU30-7	300x300	RIFWU30-9	300	RIFWG50-9	500
RIFBD440	400	RIFWU35-7	350	RIFWG10-7	1000	Bi-fold hinge system		Includes Corner Post		RIFWU40-9	400	RIFWG10-9	1000	RIFWU40-9	400
RIFBD445	450	RIFWU40-7	400	RIFWGR50-7*	500	Add 'X' to the end of the code for 350mm deep		Add 'X' to the end of the code for 350mm deep		RIFWU45-9	450	RIFWGR50-9*	500	RIFWU45-9	450
RIFBD450	500	RIFWU45-7	450	RIFWGR10-7*	1000	*Reeded Glass				RIFWU50-9	500	RIFWGR10-9*	1000	RIFWU50-9	500
RIFBD460	600	RIFWU50-7	500	Add 'X' to the end of the code for 350mm deep						RIFWU60-9	600	*Reeded Glass		RIFWU60-9	600
4 x standard drawers		RIFWU60-7	600							RIFWU80-9#	800	Add 'X' to the end of the code for 350mm deep		RIFWU80-9#	800
		RIFWU80-7#	800							RIFWU90-9#	900			RIFWU90-9#	900
		RIFWU90-7#	900							RIFWU10-9#	1000			RIFWU10-9#	1000
		RIFWU10-7#	1000											# 2 x Doors	
		Add 'X' to the end of the code for 350mm deep												Add 'X' to the end of the code for 350mm deep	

## TALL WALL

## HORIZONTAL WALL

## DRESSER WALL

Boiler Wall [400mm Deep]		Glazed		2 x Solid Doors		4 x Solid Doors		Tall Larder		Inner Drawers		Inner Drawers, Split Rail	
H:950mm CODE	WIDTH	H:340mm CODE	WIDTH	H:1220mm CODE	WIDTH	H:1400mm CODE	WIDTH	H:1220mm CODE	WIDTH	H:2020mm CODE	WIDTH	H:2020mm CODE	WIDTH
IFBWU6040-9	600	RIFWU6029	600	RIFDR50A-12	500	RIFDR50-13	500	IF4DR10-12	1000	RIFTLU30	300	RIFTLID50	500
Flatpack		RIFWU9029	900	RIFDRR50-12*	500	RIFDR50-13*	500	No bottom door rail or base bottom		RIFTLU40	400	RIFTLID60	600
		RIFWU1029	1000	1 x Full height glazed door		1 x Door and drawer		No bottom door rail or base bottom		RIFTLU50	500	Includes oak inner drawers and fronts [1 x standard & 4 deep drawers]	
		Add 'X' to the end of the code for 350mm deep		*Reeded Glass		*Reeded Glass		Flatpack		RIFTLU60	600	Fixed frame door	
				Add 'X' to the end of the code for 350mm deep		Add 'X' to the end of the code for 350mm deep		Add 'X' to the end of the code for 350mm deep				Fixed frame door	

Note: Furniture codes beginning with the letter 'R' are assembled (rigid), by removing the 'R' the units are supplied unassembled (flat-pack).

TALL LARDER TALL APPLIANCE - SINGLE DOOR TALL DRAWER PANTRY TALL STORAGE PANTRY TALL PULL-OUT LARDER

**TALL LARDER**



H:2200mm

CODE	WIDTH
RIFE-TLU30	300
RIFE-TLU40	400
RIFE-TLU50	500
RIFE-TLU60	600

**TALL APPLIANCE - SINGLE DOOR**

Fixed Frame Door



H:2020mm

CODE	WIDTH
RIFTASD30	300
RIFTASD40	400
RIFTASD45	450
RIFTASD50	500
RIFTASD60	600

**TALL APPLIANCE - SINGLE DOOR**

Fixed Frame Door - Split Rail



H:2020mm

CODE	WIDTH
RIFTASDSR30	300
RIFTASDSR40	400
RIFTASDSR45	450
RIFTASDSR50	500
RIFTASDSR60	600

Split bottom rail when used with Decorative plinth

**TALL DRAWER PANTRY**



H:2020mm

CODE	WIDTH
RIFTDPU80	800
RIFTDPU10	1000

Composed of two separate units  
Fixed frame top doors

**TALL STORAGE PANTRY**

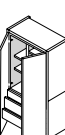

H:2020mm

CODE	WIDTH
RIFTSPU10	1000
RIFTSPUR10*	1000

Composed of two separate units  
Fixed frame doors  
\*Split bottom rail when used with Decorative plinth

**TALL PULL-OUT LARDER**

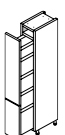

H:2020mm

CODE	WIDTH
RIFTPOL30	300

Standard Mechanism inc.  
RIFTKPOL30 300  
Kesseböhmer Mechanism inc.  
Fixed frame doors

TALL DOUBLE OVEN TALL SINGLE OVEN TALL SINGLE OVEN + COMBI TALL COMBI TALL FRIDGE/FREEZER

**TALL DOUBLE OVEN**

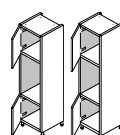

H:2200mm\*

CODE	WIDTH
RIFTDO60*	600
RIFE-TDO60	600

**TALL SINGLE OVEN**

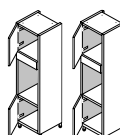

H:2200mm\*

CODE	WIDTH
RIFTSO60*	600
RIFE-TSO60	600

**TALL SINGLE OVEN + COMBI**

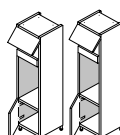

H:2020mm\*

CODE	WIDTH
RIFTSCO60*	600
RIFE-TSCO60	600

Mechanism inc.

**TALL COMBI**

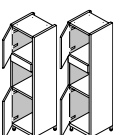

H:2020mm\*

CODE	WIDTH
RIFTCO60*	600
RIFE-TCO60	600

**TALL FRIDGE/FREEZER**

Fixed Frame Doors

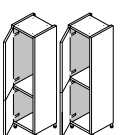

H:2020mm

CODE	WIDTH
RIFTFF1	600
RIFTFF2	600
RIFTFF1U*	600
RIFTFF2U*	600

\*For door on door appliances

**TALL FRIDGE/FREEZER**

Fixed Frame Door - Split Rail

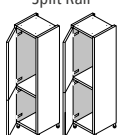

H:2020mm

CODE	WIDTH
RIFTFF1SR	600
RIFTFF2SR	600
RIFTFF1USR*	600
RIFTFF2USR*	600

\*For door on door appliances  
Split bottom rail when used with Decorative plinth

**TALL FRIDGE/FREEZER**

Fixed Frame Doors

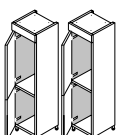

H:2200mm

CODE	WIDTH
RIFE-TFF1	600
RIFE-TFF2	600
RIFE-TFF1U*	600
RIFE-TFF2U*	600

\*For door on door appliances

**TALL FRIDGE/FREEZER**

Fixed Frame Door - Split Rail

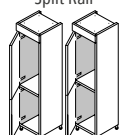

H:2200mm

CODE	WIDTH
RIFE-TFF1SR	600
RIFE-TFF2SR	600
RIFE-TFF1USR*	600
RIFE-TFF2USR*	600

\*For door on door appliances  
Split bottom rail when used with Decorative plinth

END SUPPORT PANELS CARCASE MFC PANELS CORNICE PLINTH + LEGS

**END SUPPORT PANELS**



CODE WXH

ESP	600x900
900/700	700x900

MFC Carcase

**CARCASE MFC PANELS**

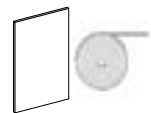

CODE WXH

1970/300	300x1970
2150/560	560x2150
2350/660	660x2350
720/300	300x720
900/2000	2000x900
900/300	300x900

MFC Carcase

**CORNICE**

Classic



CODE WXH

CO4/B	3000x90
-------	---------

Door Finish

**CORNICE**

Upstand Moulding



CODE WXH

COMU/B	3000x50
--------	---------

Door Finish  
Use in conjunction with CO4/B

**CORNICE**

Curved External Classic Section



H:90mm

CODE	WIDTH
CEC3/B	395x395

Door Finish  
Use in conjunction with CO4/B

**CORNICE**

Curved External Cornice Upstand Section



H:50mm

CODE	WIDTH
CECMU/B	337x337

Use in conjunction with COMU/B  
Door Finish

**PLINTH + LEGS**

Veneered



H:132mm

CODE	LENGTH
PLS/B	2440

Includes sealing strip  
VFS/B 3000  
Finished long edges (plinth and/or filler)  
Door Finish

PLINTH + LEGS PLANT ON END PANELS

**PLINTH + LEGS**

Curved Plinth



H:150mm

CODE	WXH
CP2/B	2440x132

Door Finish  
Use in conjunction with RIFCDBA30

**PLINTH + LEGS**

Large Curved Plinth Section



H:132mm

CODE	LENGTH
CPLS2/B	525x525

Door Finish  
Use in conjunction with RIFCDBA60

**PLINTH + LEGS**

Decorative Plinth



H:132mm

CODE	LENGTH
DPL/B	3000

Door Finish

**PLINTH + LEGS**

Decorative Curved Plinth



H:132mm

CODE	LENGTH
DCPLS/B	609x609

Door Finish  
Use in conjunction with RIFCDBA30

**PLINTH + LEGS**

Clear Sealing Strip



CODE LENGTH

PST	3000
-----	------

**PLANT ON END PANELS**

18mm Plain [Smooth]

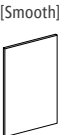

CODE WXH

2440/350PS/B	350x2440
2440/650PS/B	650x2440
950/350PS/B	350x950
885/650PS/B	650x885
900/908PS/B	908x900
900/1168PS/B	1168x900
900/2000PS/B	2000x900

Door Finish  
Plain face has the superior finish

**PLANT ON END PANELS**

18mm Tongue & Grooved [Smooth]



CODE WXH

2440/350TS/B	350x2440
2440/650TS/B	650x2440
950/350TS/B	350x950
885/650TS/B	650x885
900/908TS/B	908x900
900/1168TS/B	1168x900
900/2000TS/B	2000x900

Door Finish  
Tongue & Grooved has the superior finish

**PLANT ON END PANELS**

23mm Framed End Panels [Smooth]

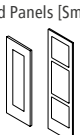

CODE WXH

FEPB/B	605x900
FEPT21/B	605x2140
FEPT23/B	605x2320
FEPW12/B	345x1220
FEPW13/B	345x1400
FEPW7/B	345x770
FEPW9/B	345x950

Door Finish

PILASTERS FURNITURE ACCESSORIES

**PILASTERS**

Square Chamfered



CODE WXH

PIL/SC910B	50x910
------------	--------

Door Finish

**PILASTERS**

Square Wide Chamfered



CODE WXH

PIL/SCW910B	72x910
-------------	--------

Door Finish

**FURNITURE ACCESSORIES**

Pre-formed Corner Post



H:770mm

CODE	WXH
CP/B**4	60x60

Door Finish

**FURNITURE ACCESSORIES**

Mitred Mantle Shelf



H:128mm

CODE	WXD
MMS/B*	2400x232

\*Specify length required

**FURNITURE ACCESSORIES**

Shaped Mantle Shelf



H:170mm

CODE	WXD
SMS/B*	2200x150

\*Specify length required

**FURNITURE ACCESSORIES**

Mantle Shelf



H:25mm

CODE	WXD
MS/B*	2400x200

\*Specify length required

**FURNITURE ACCESSORIES**

Decorative Corbel



H:219mm

CODE	WXD
COR/B	107x95

**FURNITURE ACCESSORIES**

Corbel Back Support



H:300mm

CODE	WIDTH
CBSD/B	300

FURNITURE ACCESSORIES INTEGRATED DOORS WINE CABINET DOOR CUTLERY TRAY SPARE DOOR FITTINGS GENERAL ACCESSORIES

**FURNITURE ACCESSORIES**

19mm Spacer Fillet



H:2400mm

CODE	WXD
2400/90S/19B	19x90

Door Finish

**FURNITURE ACCESSORIES**

Door Hung Spice Rack



H:1050mm

CODE	WXD
DHSR/BNO	350x106

Oak only  
Only suitable for a 500mm wide door

**INTEGRATED DOORS**

Fixed Frame Doors

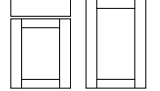

CODE WXH

IFAD45F	446x766
IFAD60F	596x766
IFAD60S	596x621
IFAD60DD	596x766
IFADW60F	596x766

Full height  
Semi-integrated  
Full height [drawerline effect]  
Full height [split rail for a dishwasher]

**WINE CABINET DOOR**



CODE WXH

IFWCD607	596x766
----------	---------

To suit a Caple W16161 wine cabinet

**CUTLERY TRAY**

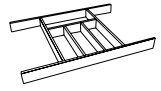

H:80mm

CODE	WXD
IFOACUT*	600x408

Oak Cutlery Tray  
\*Suits drawer 400-600

**SPARE DOOR FITTINGS**

BLIFPH	Blum Softclose In-Frame Door Hinge & Plate
BLIDHPSC	Blum Inner Drawer Hinge & Plate
HINGE90	Non Softclose hinge pack [pair]
BLSTAYHKXS	Blum Aventos HK-XS Stay
DBHBC	Decorative Blackened Copper Hinge
DBHCH	Decorative Chrome Hinge
LEGSET	Spare black adjustable legs

**GENERAL ACCESSORIES**

STPWN	Set of 2 Door Strapping Plates
TOUCH/B	1/2 Litre Paint
PCC/B	Painted Care Kit [Edging pen, soft wax stick & applicator]

Note: Furniture codes beginning with the letter 'R' are assembled (rigid), by removing the 'R' the units are supplied unassembled (flat-pack).

IN-FRAME

PRICE GROUP 9, 11 + 12

# SUTTON

Special sizes available  
contact us for further information

Primed [PG9]

Colour Options [PG11]: Auburn, Black, Bone, Dusty Rose, Cashmere, Coal, Cotton, Fern, Forest, Mink, Mist, Moss, Navy, Putty, Riptide, Sea Salt, Smoke, Space, Thyme, Twilight.

Bespoke Colour Option [PG12]



HI-LINE BASE

Pull-Out		Pull-Out Split Rail		Curved Door		Curved Return [300mm deep]		Shallow Base [300mm deep]				Chopping Board & Tray Set	
H:770mm		H:766mm		H:770mm		H:770mm		H:770mm				H:770mm	
CODE	WIDTH	CODE	WIDTH	CODE	WIDTH	CODE	WIDTH	CODE	WIDTH	CODE	WIDTH	CODE	WIDTH
RIFBA30	300	RIFBA60	600	RIFBISPO15	150	RIFCDBA30	300x300	RIFRBA26	260	RIFBSU30	300	RIFBSU60	600
RIFBA35	350	RIFBA80#	800							RIFBSU35	350	RIFBSU80#	800
RIFBA40	400	RIFBA90#	900							RIFBSU40	400	RIFBSU90#	900
RIFBA45	450	RIFBA10#	1000							RIFBSU45	450	RIFBSU10#	1000
RIFBA50	500	# 2 x Doors								RIFBSU50	500	# 2 x Doors	

HI-LINE BASE HI-LINE CORNER BASE DRAWERLINE BASE

Spice Drawer Set		Tray Set		HI-LINE CORNER BASE				'L' Shaped		DRAWERLINE BASE				Ancillary Chest Base		Open End Island Unit	
H:770mm		H:770mm		H:770mm		H:770mm		H:770mm		H:770mm		H:770mm		H:770mm			
CODE	WIDTH	CODE	WIDTH	CODE	WIDTH	CODE	WIDTH	CODE	WIDTH	CODE	WIDTH	CODE	WIDTH	CODE	WIDTH		
IFSDS207	200	IFTS207	200	RIFBAC830	800/300	RIFBAC950	900/500	IFBAC90	900x900	RIFBD30	300	RIFBD80#	800	RIFAC10	1000		
				RIFBAC80	800/400	RIFBAC960	900/600			RIFBD40	400	RIFBD90#	900				
				RIFBAC845	800/450	RIFBAC140	1000/400			RIFBD45	450	RIFBD10#	1000				
				RIFBAC850	800/500	RIFBAC145	1000/450			RIFBD50	500	# 2 x Doors					
				RIFBAC860	800/600	RIFBAC10	1000/500			RIFBD60	600						
				RIFBAC940	900/400	RIFBAC160	1000/600										
				RIFBAC945	900/450	RIFBAC12	1200/600										

BELFAST SINK BASE DRAWERLINE CORNER BASE BUILT UNDER 2 DRAWER BASE 3 DRAWER BASE

BELFAST SINK BASE		DRAWERLINE CORNER BASE		BUILT UNDER		2 DRAWER BASE		3 DRAWER BASE	
H:770mm		H:770mm		H:770mm		H:770mm		H:770mm	
CODE	WXH	CODE	WIDTH	CODE	WIDTH	CODE	WIDTH	CODE	WIDTH
RIFBSU6045	600x505	RIFBDC830	800/300	RIFBDC950	900/500	RIFBU060	600	RIFBD250	500
	To suit a sink height of 260-265mm	RIFBDC80	800/400	RIFBDC960	900/600			RIFBD280SL	800
		RIFBDC845	800/450	RIFBDC140	1000/400			RIFBD290SL	900
		RIFBDC850	800/500	RIFBDC145	1000/450			RIFBD210SL	1000
		RIFBDC860	800/600	RIFBDC10	1000/500				
		RIFBDC940	900/400	RIFBDC160	1000/600				
		RIFBDC945	900/450	RIFBDC12	1200/600				

4 DRAWER BASE MEDIUM WALL TALL WALL

4 DRAWER BASE		MEDIUM WALL		TALL WALL	
H:770mm		H:770mm		H:950mm	
CODE	WIDTH	CODE	WIDTH	CODE	WIDTH
RIFBD430	300	RIFWU30-7	300	RIFWU30-9	300
RIFBD440	400	RIFWU35-7	350	RIFWU40-9	400
RIFBD445	450	RIFWU40-7	400	RIFWU45-9	450
RIFBD450	500	RIFWU45-7	450	RIFWU50-9	500
RIFBD460	600	RIFWU50-7	500	RIFWU60-9	600

TALL WALL HORIZONTAL WALL DRESSER WALL 2 x Solid Doors 4 x Solid Doors TALL LARDER

TALL WALL		HORIZONTAL WALL		DRESSER WALL		2 x Solid Doors		4 x Solid Doors		TALL LARDER	
H:950mm		H:340mm		H:1220mm		H:1400mm		H:1220mm		H:2020mm	
CODE	WIDTH	CODE	WIDTH	CODE	WIDTH	CODE	WIDTH	CODE	WIDTH	CODE	WIDTH
IFBWU6040-9	600	RIFHWU6029	600	RIFDR50A-12	500	RIFDR50-13	500	IFADR10-12	1000	RIFTLU30	300
	Flatpack	RIFHWU9029	900	RIFDRR50-12*	500	RIFDRR50-13*	500			RIFTLU40	400
		RIFHWU1029	1000							RIFTLU50	500

Note: Furniture codes beginning with the letter 'R' are assembled (rigid), by removing the 'R' the units are supplied unassembled (flat-pack).



TALL LARDER



CODE	WIDTH
RIFE-TLU30	300
RIFE-TLU40	400
RIFE-TLU50	500
RIFE-TLU60	600

TALL APPLIANCE - SINGLE DOOR

Fixed Frame Door



CODE	WIDTH
RIFTASD30	300
RIFTASD40	400
RIFTASD45	450
RIFTASD50	500
RIFTASD60	600

Fixed Frame Door - Split Rail



CODE	WIDTH
RIFTASDSR30	300
RIFTASDSR40	400
RIFTASDSR45	450
RIFTASDSR50	500
RIFTASDSR60	600

Split bottom rail when used with Decorative plinth

TALL DRAWER PANTRY

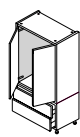

CODE	WIDTH
RIFTDPU80	800
RIFTDPU10	1000

Composed of two separate units  
Fixed frame top doors

TALL STORAGE PANTRY

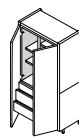

CODE	WIDTH
RIFTSPU10	1000
RIFTSPUR10*	1000

Composed of two separate units  
Fixed frame doors  
\*Split bottom rail when used with Decorative plinth

TALL PULL-OUT LARDER

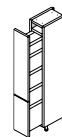

CODE	WIDTH
RIFTPOL30	300
RIFTPOLSR30*	300

Standard Mechanism inc.  
Kesseböhmer Mechanism inc.  
\*Split bottom rail when used with Decorative plinth  
Fixed frame doors

TALL DOUBLE OVEN

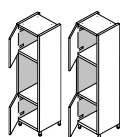

CODE	WIDTH
RIFTDO60*	600
RIFE-TDO60	600

TALL SINGLE OVEN



CODE	WIDTH
RIFTSO60*	600
RIFE-TSO60	600

TALL SINGLE OVEN + COMBI

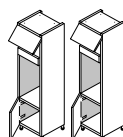

CODE	WIDTH
RIFTSCO60*	600
RIFE-TSCO60	600

Mechanism inc.

TALL COMBI

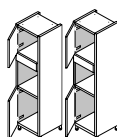

CODE	WIDTH
RIFTCO60*	600
RIFE-TCO60	600

TALL FRIDGE/FREEZER

Fixed Frame Doors

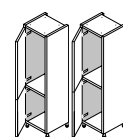

CODE	WIDTH
RIFTFF1	600
RIFTFF2	600
RIFTFF1U*	600
RIFTFF2U*	600

\*For door on door appliances

Fixed Frame Door - Split Rail

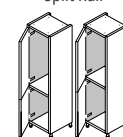

CODE	WIDTH
RIFTFF1SR	600
RIFTFF2SR	600
RIFTFF1USR*	600
RIFTFF2USR*	600

\*For door on door appliances  
Split bottom rail when used with Decorative plinth

Fixed Frame Doors

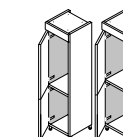

CODE	WIDTH
RIFE-TFF1	600
RIFE-TFF2	600
RIFE-TFF1U*	600
RIFE-TFF2U*	600

\*For door on door appliances

Fixed Frame Door - Split Rail

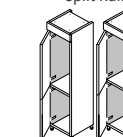

CODE	WIDTH
RIFE-TFF1SR	600
RIFE-TFF2SR	600
RIFE-TFF1USR*	600
RIFE-TFF2USR*	600

\*For door on door appliances  
Split bottom rail when used with Decorative plinth

END SUPPORT PANELS



CODE	WXH
ESP	600x900
900/700	700x900

MFC Carcase

CARCASE MFC PANELS



CODE	WXH
1970/300	300x1970
2150/560	560x2150
2350/660	660x2350
720/300	300x720
900/2000	2000x900
900/300	300x900

MFC Carcase

CORNICE

Classic



CODE	WXH
CO4/B	3000x90

Door Finish

Upstand Moulding



CODE	WXH
COMU/B	3000x50

Door Finish  
Use in conjunction with CO4/B

Curved External Classic Section



CODE	WIDTH
CEC3/B	395x395

Door Finish  
Use in conjunction with CO4/B

Curved External Cornice Upstand Section



CODE	WIDTH
CECMU/B	337x337

Use in conjunction with COMU/B  
Door Finish

PLINTH + LEGS



CODE	LENGTH
PLS/B	2440
VFS/B	3000

Includes sealing strip  
Finished long edges [plinth and/or filler]  
Door Finish

PLINTH + LEGS



CODE	WXH
CPL2/B	2440x132

Door Finish  
Use in conjunction with RIFCDBA30

Large Curved Plinth Section



CODE	LENGTH
CPLS2/B	525x525

Door Finish  
Use in conjunction with RIFCDBA60

Decorative Plinth



CODE	LENGTH
DPL/B	3000

Door Finish

Decorative Curved Plinth



CODE	LENGTH
DCPLS/B	609x609

Door Finish  
Use in conjunction with RIFCDBA30

Clear Sealing Strip



CODE	LENGTH
PST	3000

PLANT ON END PANELS

18mm Plain [Smooth]



CODE	WXH
2440/350PS/B	350x2440
2440/650PS/B	650x2440
950/350PS/B	350x950
885/650PS/B	650x885
900/908PS/B	908x900
900/1168PS/B	1168x900
900/2000PS/B	2000x900

Door Finish  
Plain face has the superior finish

18mm Tongue & Grooved [Smooth]

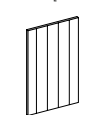

CODE	WXH
2440/350TS/B	350x2440
2440/650TS/B	650x2440
950/350TS/B	350x950
885/650TS/B	650x885
900/908TS/B	908x900
900/1168TS/B	1168x900
900/2000TS/B	2000x900

Door Finish  
Tongue & Grooved has the superior finish

23mm Framed End Panels [Smooth]

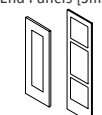

CODE	WXH
FEPB/B	605x900
FEPT21/B	605x2140
FEPT23/B	605x2320
FEPW12/B	345x1220
FEPW13/B	345x1700
FEPW7/B	345x700
FEPW9/B	345x950

Door Finish

PILASTERS

Square Chamfered



CODE	WXH
PIL/SC910B	50x910

Door Finish

Square Wide Chamfered



CODE	WXH
PIL/SCW910B	72x910

Door Finish

Pre-formed Corner Post



CODE	WXH
CP/B**4	60x60

Door Finish

Mitred Mantle Shelf



CODE	WXD
MMS/B*	2400x232

\*Specify length required

Shaped Mantle Shelf



CODE	WXD
SMS/B*	2200x150

\*Specify length required

Mantle Shelf



CODE	WXD
MS/B*	2400x200

\*Specify length required

Decorative Corbel



CODE	WXD
COR/B	107x95

Corbel Back Support

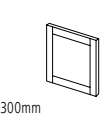

CODE	WIDTH
CBSD/B	300

FURNITURE ACCESSORIES

19mm Spacer Fillet



CODE	WXD
2400/90S/19B	19x90

Door Finish

Door Hung Spice Rack



CODE	WXD
DHSR/BNO	350x106

Oak only  
Only suitable for a 500mm wide door

INTEGRATED DOORS

Fixed Frame Doors

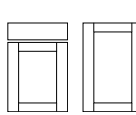

CODE	WXH
IFAD45F	446x766
IFAD60F	596x766
IFAD60S	596x621
IFAD60DD	596x766
IFADW60F	596x766

Semi-integrated  
Full height [drawerline effect]  
Full height [split rail for a dishwasher]

WINE CABINET DOOR

Fixed Frame Doors

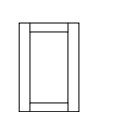

CODE	WXH
IFWCD607	596x766

To suit a Caple Wi6161 wine cabinet

CUTLERY TRAY

Fixed Frame Doors

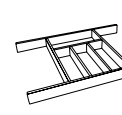

CODE	WXD
IFOAKCUT*	600x408

Oak Cutlery Tray  
\*Suits drawer 400-600

SPARE DOOR FITTINGS

Fixed Frame Doors

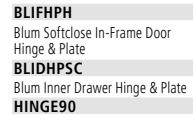

CODE	DESCRIPTION
BLIFPH	Blum Softclose In-Frame Door Hinge & Plate
BLIDHPSC	Blum Inner Drawer Hinge & Plate
HINGE90	Non Softclose hinge pack [pair]
BLSTAYHXS	Blum Aventos HK-XS Stay
DBHVC	Decorative Blackened Copper Hinge
DBHCH	Decorative Chrome Hinge
LEGSET	Spare black adjustable legs

GENERAL ACCESSORIES

Fixed Frame Doors

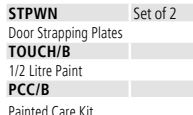

CODE	DESCRIPTION
STPWN	Set of 2 Door Strapping Plates
TOUCH/B	1/2 Litre Paint
PCC/B	Painted Care Kit [Edging pen, soft wax stick & applicator]

Note: Furniture codes beginning with the letter 'R' are assembled (rigid), by removing the 'R' the units are supplied unassembled (flat-pack).

IN-FRAME

PRICE GROUP 9, 11 + 12

# WINFORD



Special sizes available

contact us for further information

Primed [PG9]

Colour Options [PG11]: Auburn, Black, Bone, Dusty Rose, Cashmere, Coal, Cotton, Fern, Forest, Mink, Mist, Moss, Navy, Putty, Riptide, Sea Salt, Smoke, Space, Thyme, Twilight.

Bespoke Colour Option [PG12]



HI-LINE BASE

H:738mm		H:738mm		H:735mm		H:738mm		H:735mm		H:738mm		H:738mm			
CODE	WIDTH	CODE	WIDTH	CODE	WIDTH	CODE	WIDTH	CODE	WIDTH	CODE	WIDTH	CODE	WIDTH		
RIFBA30	300	RIFBA60	600	RIFBISPO15	150	RIFCDBA30	300x300	RIFCRBA26	260	RIFSBU30	300	RIFSBU60	600	IFSDS207	200
RIFBA35	350	RIFBA80#	800	Standard Mechanism inc.		Mechanism inc.		Fixed frame door		RIFSBU35	350	RIFSBU80#	800		
RIFBA40	400	RIFBA90#	900	RIFBKPO15	150					RIFSBU40	400	RIFSBU90#	900		
RIFBA45	450	RIFBA10#	1000	Kesseböhmer Mechanism inc.						RIFSBU45	450	RIFSBU10#	1000		
RIFBA50	500	# 2 x Doors		RIFBKTP015	150					RIFSBU50	500	# 2 x Doors			
				Kesseböhmer Mechanism & towel rail inc.											
				Fixed frame door											

HI-LINE BASE

H:738mm		H:738mm	
CODE	WIDTH	CODE	WIDTH
IFTS207	200	RIFBOS60	600
		RIFBOS10	1000
		Veneered frame with MFC Carcase	
		Ready assembled unit	

LOW BASE

H:593mm	
CODE	WIDTH
RIFLBU60	600

HI-LINE CORNER BASE

H:738mm			
CODE	WIDTH	CODE	WIDTH
RIFBAC830	800/300	RIFBAC950	900/500
RIFBAC80	800/400	RIFBAC960	900/600
RIFBAC845	800/450	RIFBAC140	1000/400
RIFBAC850	800/500	RIFBAC145	1000/450
RIFBAC860	800/600	RIFBAC10	1000/500
RIFBAC940	900/400	RIFBAC160	1000/600
RIFBAC945	900/450	RIFBAC12	1200/600
		Inc. Corner Post & Blanking Panel	

DRAWERLINE BASE

H:738mm		H:738mm	
CODE	WIDTH	CODE	WIDTH
IFBAC90	900x900	RIFBD30	300
	Bi-fold hinge system Flatpack	RIFBD40	400
		RIFBD45	450
		RIFBD50	500
		RIFBD60	600
		RIFBD80#	800
		RIFBD90#	900
		RIFBD10#	1000
		# 2 x Doors	
		RIFBOSD50	500
		RIFBOSD60	600
		Veneered frame with MFC Carcase	

DRAWERLINE BASE

H:738mm		H:870mm	
CODE	WIDTH	CODE	WIDTH
RIFAC10	1000	OEU19*	910x500
		OEU12*	1170x500
		Includes drawer box and runners	
		*Not available as a Primed Finish	
		Ready assembled unit	

BELFAST SINK BASE

H:738mm	
CODE	WXH
RIFBSU6046	600x478
To suit a sink height of 255-260mm	
RIFBSU6050	600x516
RIFBSU8050#	800x516
To suit a sink height of 217-222mm	
# 2 x Doors	

DRAWERLINE CORNER BASE

H:738mm			
CODE	WIDTH	CODE	WIDTH
RIFBDC830	800/300	RIFBDC950	900/500
RIFBDC80	800/400	RIFBDC960	900/600
RIFBDC845	800/450	RIFBDC140	1000/400
RIFBDC850	800/500	RIFBDC145	1000/450
RIFBDC860	800/600	RIFBDC10	1000/500
RIFBDC940	900/400	RIFBDC160	1000/600
RIFBDC945	900/450	RIFBDC12	1200/600
		Inc. Corner Post & Blanking Panel	

BUILT UNDER OVEN

H:738mm	
CODE	WIDTH
RIFBU060	600

2 DRAWER BASE

H:738mm	
CODE	WIDTH
RIFCD250	500
2 x deep drawers	
Oak drawers	
RIFBD250	500
RIFBD260	600
RIFBD280	800
RIFBD290	900
RIFBD210	1000
2 x Deep drawers	

3 DRAWER BASE

H:738mm	
CODE	WIDTH
RIFBD350	500
RIFBD360	600
RIFBD380	800
RIFBD390	900
RIFBD310	1000
1 x standard	
2 x deep drawers	

4 DRAWER BASE

H:738mm	
CODE	WIDTH
RIFBD430	300
RIFBD440	400
RIFBD445	450
RIFBD450	500
RIFBD460	600
4 x standard drawers	

MEDIUM WALL

H:738mm	
CODE	WIDTH
RIFWU30-7	300
RIFWU35-7	350
RIFWU40-7	400
RIFWU45-7	450
RIFWU50-7	500
Add 'X' to the end of the code for 350mm deep	
RIFWU60-7	600
RIFWU80-7#	800
RIFWU90-7#	900
RIFWU10-7#	1000
# 2 x Doors	

H:738mm	
CODE	WIDTH
RIFWG50-7	500
RIFWG10-7	1000
Add 'X' to the end of the code for 350mm deep	

H:738mm	
CODE	WIDTH
RIFCWL60-7	600x600
Bi-fold hinge system	
Add 'X' to the end of the code for 350mm deep	
[650x650]	

H:738mm	
CODE	WIDTH
RIFWU60-7	600
Includes Corner Post	
Add 'X' to the end of the code for 350mm deep	

H:738mm	
CODE	WIDTH
RIFCDWU30-7	300x300

MEDIUM WALL

H:738mm	
CODE	WIDTH
RIFWOS60-7	600
RIFWOS10-7	1000
Veneered frame with MFC Carcase	

TALL WALL

H:918mm	
CODE	WIDTH
RIFWU30-9	300
RIFWU40-9	400
RIFWU45-9	450
RIFWU50-9	500
RIFWU60-9	600
RIFWU80-9#	800
RIFWU90-9#	900
RIFWU10-9#	1000
# 2 x Doors	
Add 'X' to the end of the code for 350mm deep	

Glazed

H:918mm	
CODE	WIDTH
RIFWG50-9	500
RIFWG10-9	1000
Add 'X' to the end of the code for 350mm deep	

Boiler Wall [400mm Deep]

H:918mm	
CODE	WIDTH
IFBWU6040-9	600
Flatpack	

HORIZONTAL WALL

H:308mm	
CODE	WIDTH
RIFHWU6029	600
RIFHWU9029	900
RIFHWU1029	1000
Mechanism inc.	
Add 'X' to the end of the code for 350mm deep	

Glazed Door

H:308mm	
CODE	WIDTH
RIFHGWU5029	500
Mechanism inc.	
Add 'X' to the end of the code for 350mm deep	

DRESSER WALL

H:1210mm	
CODE	WIDTH
RIFDR50B-12	500
1 x Door and drawer	
Add 'X' to the end of the code for 350mm deep	

DRESSER WALL

H:1210mm	
CODE	WIDTH
RIFDR10-12	1000
Add 'X' to the end of the code for 350mm deep	

TALL LARDER



H:1988mm  
CODE  
**RIFTLU30** WIDTH 300  
**RIFTLU40** 400  
**RIFTLU50** 500  
**RIFTLU60** 600

Inner Drawers

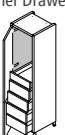

H:1988mm  
CODE  
**RIFTLID50** WIDTH 500  
**RIFTLID60** 600  
Includes oak inner drawers and fronts  
[1 x standard & 4 deep drawers]

H:2168mm  
CODE  
**RIFE-TLU30** WIDTH 300  
**RIFE-TLU40** 400  
**RIFE-TLU50** 500  
**RIFE-TLU60** 600

TALL DRAWER PANTRY

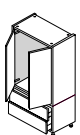

H:1988mm  
CODE  
**RIFDPU10** WIDTH 1000  
Composed of two separate units  
Fixed frame top doors

TALL STORAGE UNIT

Single Door  
H:1988mm  
CODE  
**RIFTSU30** WIDTH 300  
**RIFTSU50** 500

TALL PULL-OUT LARDER

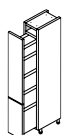

H:1988mm  
CODE  
**RIFTPOL30** WIDTH 300  
Standard Mechanism inc.  
**RIFTKPOL30** 300  
Kessebohmer Mechanism inc.  
Fixed frame doors

TALL DOUBLE OVEN

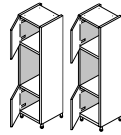

H:1988mm\* H:2168mm  
CODE  
**RIFTDO60\*** WIDTH 600  
**RIFE-TDO60** 600

TALL SINGLE OVEN

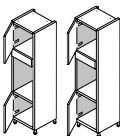

H:1988mm\* H:2168mm  
CODE  
**RIFTSO60\*** WIDTH 600  
**RIFE-TSO60** 600

TALL SINGLE OVEN + COMBI

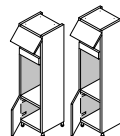

H:1988mm\* H:2168mm  
CODE  
**RIFTSOCO60\*** WIDTH 600  
**RIFE-TSCO60** 600  
Mechanism inc.

TALL COMBI

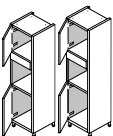

H:1988mm\* H:2168mm  
CODE  
**RIFTCO60\*** WIDTH 600  
**RIFE-TCO60** 600

TALL FRIDGE/FREEZER

Fixed Frame Doors  
H:1988mm  
CODE  
**RIFTF1** WIDTH 600  
**RIFTF2** 600  
**RIFTF1U\*** 600  
**RIFTF2U\*** 600  
\*For door on door appliances

TALL FRIDGE/FREEZER

Fixed Frame Doors  
H:2168mm  
CODE  
**RIFE-TFF1** WIDTH 600  
**RIFE-TFF2** 600  
**RIFE-TFF1U\*** 600  
**RIFE-TFF2U\*** 600  
\*For door on door appliances

END SUPPORT PANELS



CODE  
**ESP** WXX 600x900  
700x900  
MFC Carcase

CARCASE MFC PANELS

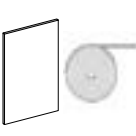

CODE WXX  
**1970/300** 300x1970  
**2150/560** 560x2150  
**2350/660** 660x2350  
**720/300** 300x720  
**900/2000** 2000x900  
**900/300** 300x900  
MFC Carcase  
**UG/DOET** 1000x22  
\*Un-glued 1m carcase edging

CORNICE

Classic  
CODE  
**COCL/B** WXX 3000x80  
Door Finish

Contemporary  
CODE  
**COC/B** WXX 3000x46  
Door Finish

Curved External Classic Section  
H:28mm  
CODE  
**PCM/B** WIDTH 3000  
Door Finish

Curved External Combi Section  
H:46mm  
CODE  
**CEC2/B** WIDTH 370x370  
Door Finish  
Use in conjunction with COC/B

Curved External Combi Section  
H:28mm  
CODE  
**CEPCM/B** WIDTH 335x335  
Door Finish  
Use in conjunction with PCM/B

LIGHT BAFFLE

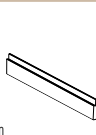

H:50mm  
CODE  
**LB/B** WIDTH 3000  
Door Finish

PLINTH + LEGS

Veneered  
H:150mm  
CODE  
**PL/B** LENGTH 2440  
Includes sealing strip  
**VF/B** 3000  
Finished long edges  
[plinth and/or filler]  
Door finish

PLINTH + LEGS

Curved Plinth  
H:150mm  
CODE  
**CPL/B** LENGTH 2440

PLANT ON END PANELS

Clear Sealing Strip  
CODE  
**PST** LENGTH 3000

PLANT ON END PANELS

18mm Tongue & Grooved Reversible  
CODE WXX  
**2440/390T/B** 390x2440  
**2440/650T/B** 650x2440  
**950/390T/B** 390x950  
**885/650T/B** 650x885  
T&G face has the superior finish  
Painted  
**NOT** Bone, Cotton, Fern, Putty, Riptide, Space & Twilight

PLANT ON END PANELS

18mm Plain Reversible  
CODE WXX  
**2440/390P/B** 390x2440  
**2440/650P/B** 650x2440  
**950/390P/B** 390x950  
**885/650P/B** 650x885  
Plain face has the superior finish  
Painted  
**NOT** Bone, Cotton, Fern, Putty, Riptide, Space & Twilight

PLANT ON END PANELS

18mm Tongue & Grooved Plain Reversible  
CODE WXX  
**2440/390/B** 390x2440  
**2440/650/B** 650x2440  
**950/390/B** 390x950  
**885/650/B** 650x885  
Painted  
**ONLY** Bone, Cotton, Fern, Putty, Riptide, Space & Twilight

PLANT ON END PANELS

18mm Tongue & Grooved / Plain Reversible Breakfast Bar Panel  
CODE WXX  
**900/2000T/B** 2000x900  
T&G face has the superior finish  
**900/2000P/B** 2000x900  
Plain face has the superior finish  
**NOT** Bone, Cotton, Fern, Putty, Riptide, Space & Twilight  
**900/2000/B** 2000x900  
**ONLY** Bone, Cotton, Fern, Putty, Riptide, Space & Twilight

PILASTERS

Square  
CODE  
**PIL/S910B** WXX 50x910  
Door Finish

Square Chamfered  
CODE  
**PIL/SC910B** WXX 50x910  
Door Finish

Square Wide Chamfered  
CODE  
**PIL/SCW910B** WXX 72x910  
Door Finish

Curved  
CODE  
**PIL/CUR910B** WXX 50x910  
**PIL/CUR1350B** 50x1350  
**PIL/CUR2150B** 50x2150  
Door Finish

FURNITURE ACCESSORIES

Pre-formed Corner Post  
H:738mm  
CODE  
**CP/B\*\*3** WXX 60x60  
Door Finish

Mantle Shelf  
H:25mm  
CODE  
**MS/B** WXD 2400x200  
Specify length required

Decorative Corbel  
H:219mm  
CODE  
**COR/B** WXD 107x95

Corbel Back Support  
H:300mm  
CODE  
**CBSC/B** WIDTH 300

FURNITURE ACCESSORIES

19mm Spacer Fillet  
H:2400mm  
CODE  
**2400/90/19B** WIDTH 19  
Door Finish

INTEGRATED DOORS

Door Hung Spice Rack  
H:1050mm  
CODE  
**DHSR** WXD 350x106  
Oak only  
Only suitable for a 500mm wide door

WINE CABINET DOOR

Fixed Frame Doors  
CODE WXX  
**IFAD45F** 447x735  
**IFAD60F** 597x735  
Full height  
**IFAD45DD** 446x735  
**IFAD60DD** 597x735  
Full height drawer line effect  
**IFAD60S** 597x590  
Semi-integrated

WINE CABINET DOOR

Wine Cabinet Door  
CODE WXX  
**IFWCD607** 596x735  
To suit a Caple W16161 wine cabinet

CUTLERY TRAY

Cutlery Tray  
H:80mm  
CODE  
**IFOAKCUT\*** WXD 600x408  
Oak Cutlery Tray  
\*Suits drawer 400-600

SPARE DOOR FITTINGS

SPARE DOOR FITTINGS  
CODE  
**BLIFHP** Blum Softclose In-Frame Door Hinge & Plate  
**BLIDHPSC** Blum Inner Drawer Hinge & Plate  
**HINGE90** Non Softclose hinge pack [pair]  
**BLSTAYHKXS** Blum Aventos HK-XS Stay  
**DBHBC** Decorative Blackened Copper Hinge  
**DBHCH** Decorative Chrome Hinge  
**LEGSET** Spare black adjustable legs

GENERAL ACCESSORIES

GENERAL ACCESSORIES  
CODE  
**STPWN** Set of 2 Door Strapping Plates  
**TOUCH/B** 1/2 Litre Paint  
**PCC/B** Painted Care Kit [Edging pen, soft wax stick & applicator]

Note: Furniture codes beginning with the letter 'R' are assembled (rigid), by removing the 'R' the units are supplied unassembled (flat-pack).



AT A GLANCE

# VERSE HANDLELESS



Introducing Verse, the handleless collection from Caple. The uninterrupted, smooth lines give this range a premium and contemporary look with no need for handles. Verse utilises an integrated aluminium rail system that creates a space between cabinets to allow opening and closing of doors and drawers.

A choice of on-trend textured, matt, gloss and painted door finishes with a variety of complementary rail colours, Verse gives you complete freedom with design.

## 12 RAIL COLOURS



## BESPOKE PAINTED COLOUR

Our bespoke painted colour service means we can match your chosen Verse furniture to any paint manufacturer's colour swatch. Let your imagination run wild and choose something which will inspire you.





VERSE

PRICE GROUP 2  
**BRAVA**

Special sizes available  
contact us for further information

Colours Options [PG2]: Concrete, Dark Oak and Rustic Iron.



HI-LINE BASE

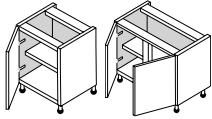

Pull-Out

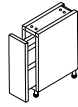

Shallow Base [300mm deep]

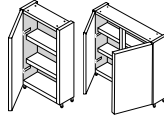

HI-LINE CORNER BASE

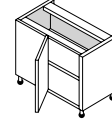

'L' Shaped

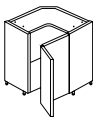

H:720mm CODE	WIDTH	CODE	WIDTH
RVBA15	150	RVBA70	700
RVBA30	300	RVBA80	800
RVBA35	350	RVBA90	900
RVBA40	400	RVBA10	1000
RVBA45	450	RVBA12	1200
RVBA50	500		
RVBA60	600		

H:720mm CODE	WIDTH
RVBISPO15	150

Standard Mechanism inc.  
RVBKPO15 150  
Kesseböhmer Mechanism inc.  
RVBKTP015 150  
Kesseböhmer Mechanism & Towel rail inc.

H:720mm CODE	WIDTH	CODE	WIDTH
RVSBU30	300	RVSBU70	700
RVSBU35	350	RVSBU80	800
RVSBU40	400	RVSBU90	900
RVSBU45	450	RVSBU10	1000
RVSBU50	500		
RVSBU60	600		

H:720mm CODE	WIDTH	CODE	WIDTH
RVBAC830	800/300	RVBAC950	900/500
RVBAC80	800/400	RVBAC960	900/600
RVBAC845	800/450	RVBAC140	1000/400
RVBAC850	800/500	RVBAC145	1000/450
RVBAC860	800/600	RVBAC10	1000/500
RVBAC940	900/400	RVBAC160	1000/600
RVBAC945	900/450	RVBAC12	1200/600

H:720mm CODE	WIDTH
VBAC90	900x900

Bi-fold hinge system  
Flatpack

Incl. Corner Post & Blanking Panel

BUILT UNDER OVEN

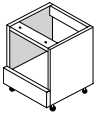

H:720mm CODE	WIDTH
RBUE06*	600

\*Non-verse spec.

2 DRAWER BASE

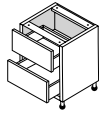

H:720mm CODE	WIDTH
RVBD250	500
RVBD260	600
RVBD280	800
RVBD290	900
RVBD210	1000

2x325mm Drawers

3 DRAWER BASE

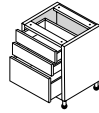

H:720mm CODE	WIDTH
RVBD350	500
RVBD360	600
RVBD380	800
RVBD390	900
RVBD310	1000

2x160mm, 1x325mm Drawers

LOW WALL

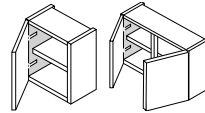

H:575mm CODE	WIDTH
RVWU30-5	300
RVWU40-5	400
RVWU45-5	450
RVWU50-5	500
RVWU60-5	600

MEDIUM WALL

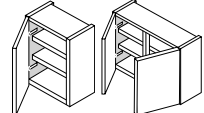

H:720mm CODE	WIDTH	D:300mm	H:720mm CODE	WIDTH	D:300mm
RVWU80-5	800		RVWU30-7	300	
RVWU90-5	900		RVWU35-7	350	
RVWU10-5	1000		RVWU40-7	400	
			RVWU45-7	450	
			RVWU50-7	500	
			RVWU60-7	600	
			RVWU70-7	700	
			RVWU80-7	800	
			RVWU90-7	900	
			RVWU10-7	1000	

Add 'X' to the end of the code for 350mm deep

Add 'X' to the end of the code for 350mm deep

MEDIUM WALL

'L' Shaped Corner

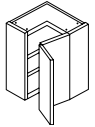

H:720mm CODE	D:300mm WIDTH
RVCWL60-7	600x600

Add 'X' to the end of the code for 350mm deep [650x650]  
Bi-Fold Hinge System

Bi-Fold

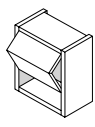

H:720mm CODE	D:300mm WIDTH
RVBFWU50-7	500
RVBFWU60-7	600
RVBFWU80-7	800
RVBFWU90-7	900
RVBFWU10-7	1000

Mechanism inc.  
Add 'X' to the end of the code for 350mm deep

TALL WALL

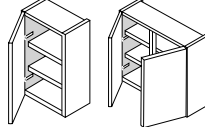

H:900mm CODE	WIDTH	D:300mm CODE	WIDTH
RVWU30-9	300	RVWU80-9	800
RVWU40-9	400	RVWU90-9	900
RVWU45-9	450	RVWU10-9	1000
RVWU50-9	500		
RVWU60-9	600		

Add 'X' to the end of the code for 350mm deep

Boiler

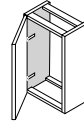

H:900mm CODE	WIDTH
VBWU6040-9	600

400mm deep  
Flatpack

HORIZONTAL WALL

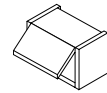

H:290mm CODE	D:300mm WIDTH	H:360mm CODE	D:300mm WIDTH
RVHWU5029	500	RVHWU5036	500
RVHWU6029	600	RVHWU6036	600
RVHWU8029	800	RVHWU8036	800
RVHWU9029	900	RVHWU9036	900
RVHWU1029	1000	RVHWU1036	1000

All include Blum Aventos HKS System  
Add 'X' to the end of the code for 350mm deep

MIDI UNITS

RVRMLU60 RVMA160

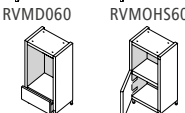
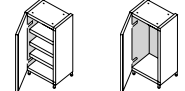

H:1250mm CODE	WIDTH
RVRMLU60	600
RVMA160	600
RVMD060	600
RVMOHS60	600

LARDER

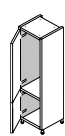

H:1970mm CODE	WIDTH
RVTLU30	300
RVTLU40	400
RVTLU50	500
RVTLU60	600

Single Door

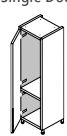

H:1970mm CODE	WIDTH
RVTLUSD50	500
RVTLUSD60	600

H:2150mm CODE	WIDTH
RVETLU30	300
RVETLU40	400
RVETLU50	500
RVETLU60	600

PULL-OUT LARDER

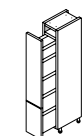

H:1970mm CODE	*H:2150mm WIDTH
RVTISPOL30	300
RVTKPOL30	300

Standard Mechanism inc.  
RVETISPOL30\* 300  
RVETKPOL30\* 300  
Kesseböhmer Mechanism inc.

INNER DRAWER LARDER

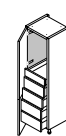

H:1970mm CODE	WIDTH
RVTLID30	300
RVTLID40	400
RVTLID50	500
RVTLID60	600



H:2150mm CODE	WIDTH
RVETLID30	300
RVETLID40	400
RVETLID50	500
RVETLID60	600

1x Standard, 4x Deep Drawers

DOUBLE OVEN

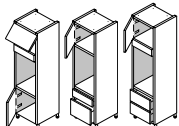

H:1970mm CODE	*H:2150mm WIDTH
RVTOHD60	600
RVTOHDD60	600
RVTOHDD60*	600

SINGLE OVEN

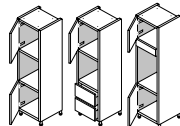

H:1970mm CODE	*H:2150mm WIDTH
RVTOHS60	600
RVTOHSD60	600
RVTOHS60*	600

SINGLE OVEN + COMPACT

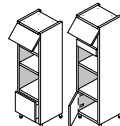

H:1970mm CODE	*H:2150mm WIDTH
RVTOHSC60	600
RVTOHSC60*	600

COMPACT

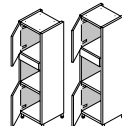

H:1970mm CODE	*H:2150mm WIDTH
RVTOHC60	600
RVETOHC60*	600

FRIDGE + FRIDGE/FREEZER

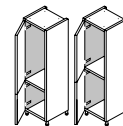

H:1970mm CODE	WIDTH
RVTF1/60	600
RVTF4/60*	600
RVTF1U/60*	600
RVTF4U/60*	600

\*Doors undrilled  
\*For door on door appliances



H:2150mm CODE	WIDTH
RVETFF1/60	600
RVETFF2/60	600
RVETFF1U/60*	600
RVETFF2U/60*	600

\*For door on door appliances

END SUPPORT PANELS

CARCASE MFC PANELS

COMBI

PLINTH

PLANT ON END PANELS

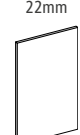
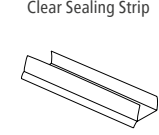
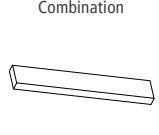
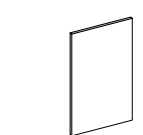
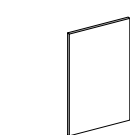

H:900mm

CODE	WIDTH
<b>ESP</b>	600
<b>900/700</b>	700

MFC Carcase

CODE	WXH
<b>1970/300</b>	300x1970
<b>2150/560</b>	560x2150
<b>2350/660</b>	660x2350
<b>720/300</b>	300x720
<b>900/2000</b>	2000x900
<b>900/300</b>	300x900

MFC Carcase

CODE	WXH
<b>UG/**ET</b>	1000x22
Un-Glued 1m Carcase Edging	
<b>SET/B</b>	5000x29
Un-glued 5M roll - Door Finish	

H:22mm

CODE	WIDTH
<b>PCM/B</b>	2700

Door Finish

H:150mm

CODE	WIDTH
<b>PL</b>	2940
Melamine [Carcase MFC]	
<b>PL/B</b>	2700
Door Finish	

CODE	WIDTH
<b>PST</b>	3000

Plinth sealing strip 3mtr

CODE	WXH
<b>2440/350/22B</b>	350x2440
<b>2440/650/22B</b>	650x2440
<b>900/650/22B</b>	650x900
<b>950/350/22B</b>	350x950
<b>900/1170/22B</b>	1170x900
<b>900/910/22B</b>	910x900

Door Finish

PLANT ON END PANELS

22mm Breakfast Bar Panel

50mm Mitred End Panel

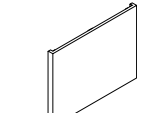

CODE	HxW
<b>900/2400/22B</b>	900x2400

Door finish

CODE	WXH
<b>MBEPA/B</b>	604x684
<b>MBEPB/B</b>	604x325

Base run

CODE	WXH
<b>MIEP9A/B</b>	908x684
<b>MIEP9B/B</b>	908x325
<b>MIEP12A/B</b>	1168x684
<b>MIEP12B/B</b>	1168x325

Island Door Finish

FURNITURE ACCESSORIES

Corner Post [Spare]

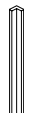

H:684mm

CODE	WIDTH
<b>CPTH/B</b>	146

Flat panel for on site conversion

INTEGRATED DOORS

Undrilled

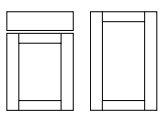

CODE	WXH
<b>INT4568</b>	446x684
<b>INT4571</b>	446x715
<b>INT6045</b>	596x450

CODE	WXH
<b>INT6068</b>	596x684
<b>INT6071</b>	596x715

SPARE DOOR FITTINGS

Hinges [Hettich Soft Close]

CODE	
<b>SCHINGE90</b>	
90 degree [Pair]	
<b>SCHINGE170</b>	
170 degree [Pair]	

CODE	Set of
<b>STPWN</b>	2
Door strapping plates	
<b>LEGSET</b>	4
Adjustable legs	

Stays [Blum Aventos]

CODE	
<b>BLSTAYHKS</b>	
HK-S stay [Pair]	
*[inc mounting brackets]	

GOLA PROFILES - STANDARD

Base Units

Wall Units

Tall Units

CODE	LENGTH
<b>NGPTOP**</b>	4100
Top profile	
<b>NGPMID**</b>	4100
Mid profile	
<b>NGPFIXB</b>	
Fixing brackets [pack 10]	
<b>NGPTOPCAP**</b>	
Top profile end caps [Pr]	
<b>NGPMIDCAP**</b>	
Mid profile end caps [Pr]	

CODE	LENGTH
<b>NGPTOPEXT**</b>	
Top profile external corner	
<b>NGPTOPINT**</b>	
Top profile internal corner	
<b>NGPMIDEXT**</b>	
Mid profile external corner	
<b>NGPMIDINT**</b>	
Mid profile internal corner	
<b>NGPILCON</b>	
In-line connector	

CODE	LENGTH
<b>NGPWALL**</b>	3900

CODE	LENGTH
<b>NGPVS**</b>	2250
Vertical single profile	
<b>NGPVD**</b>	2250
Vertical double profile	
<b>NGPFIXVS</b>	
Vertical SINGLE fixing [each]	
- 4 required per rail	
<b>NGPFIXVD</b>	
Vertical DOUBLE fixing [each]	
- 4 required per rail	

CODE	
<b>NGPFIXVBKT</b>	
Vertical rear fixing bracket [each]	
- 4 required per rail	
<b>NGPAF580**</b>	
Appliance filler 580mm	



Standard colours  
- Matt Black [MB] and Anodised Steel [AS]

GOLA PROFILES - BESPOKE PAINTED - SOLID COLOURS

Base Units

Wall Units

Tall Units

CODE	LENGTH
<b>NGPTOP**</b>	3000
Top profile	
<b>NGPMID**</b>	3000
Mid profile	
<b>NGPFIX10</b>	
Fixing brackets [pack 10]	
<b>NGPTOPCAP**</b>	
Top profile end caps [Pr]	
<b>NGPMIDCAP**</b>	
Mid profile end caps [Pr]	

CODE	LENGTH
<b>NGPTOPEXT**</b>	
Top profile external corner	
<b>NGPTOPINT**</b>	
Top profile internal corner	
<b>NGPMIDEXT**</b>	
Mid profile external corner	
<b>NGPMIDINT**</b>	
Mid profile internal corner	
<b>NGPILCON</b>	
In-line connector	

CODE	LENGTH
<b>NGPWALL**</b>	3000

CODE	LENGTH
<b>NGPVS**</b>	2250
Vertical single profile	
<b>NGPVD**</b>	2250
Vertical double profile	
<b>NGPFIXVS</b>	
Vertical SINGLE fixing [each]	
- 4 required per rail	
<b>NGPFIXVD</b>	
Vertical DOUBLE fixing [each]	
- 4 required per rail	

CODE	
<b>NGPFIXVBKT</b>	
Vertical rear fixing bracket [each]	
- 4 required per rail	
<b>NGPAF580**</b>	
Appliance filler 580mm	



Bespoke solid colours  
- Dark Blue [DB], Grey Blue [GB], Graphite [GR], Leaf [LF], Light Grey [LG], Luna [LU], Peacock [PC] and Stone Blue [SB]

GOLA PROFILES - BESPOKE PAINTED - SHIMMERING COLOURS

Base Units

Wall Units

Tall Units

CODE	LENGTH
<b>NGPTOP**</b>	3000
Top profile	
<b>NGPMID**</b>	3000
Mid profile	
<b>NGPFIX10</b>	
Fixing brackets [pack 10]	
<b>NGPTOPCAP**</b>	
Top profile end caps [Pr]	
<b>NGPMIDCAP**</b>	
Mid profile end caps [Pr]	

CODE	LENGTH
<b>NGPTOPEXT**</b>	
Top profile external corner	
<b>NGPTOPINT**</b>	
Top profile internal corner	
<b>NGPMIDEXT**</b>	
Mid profile external corner	
<b>NGPMIDINT**</b>	
Mid profile internal corner	
<b>NGPILCON</b>	
In-line connector	

CODE	LENGTH
<b>NGPWALL**</b>	3000

CODE	LENGTH
<b>NGPVS**</b>	2250
Vertical single profile	
<b>NGPVD**</b>	2250
Vertical double profile	
<b>NGPFIXVS</b>	
Vertical SINGLE fixing [each]	
- 4 required per rail	
<b>NGPFIXVD</b>	
Vertical DOUBLE fixing [each]	
- 4 required per rail	

CODE	
<b>NGPFIXVBKT</b>	
Vertical rear fixing bracket [each]	
- 4 required per rail	
<b>NGPAF580**</b>	
Appliance filler 580mm	



Bespoke Shimmering Colours  
- Gold Dust [GD] and Rose Gold [RG]

- > When installing an integrated under counter appliance, please check the appliance height carefully to establish if it will fit below the top profile [812mm high or less]. The plinth height can be raised slightly to accommodate taller appliances.
  - > If using free-standing appliances, end panels must be fitted either side of the appliance and the rail profile finishes against the panel, and end caps fitted if required.
  - > A top rail profile cannot be used with a built-under single oven in the Verse range. The rails must stop on each side of the appliance and end caps fitted.
  - > When using a 'L' shaped corner wall unit, the Verse wall rail will need to be mitred on site.
  - > When planning ensure a 30mm gap is left between, or to the side of all Midi & Tall housings for the vertical profile to be fitted.
  - > When ordering Midi and Tall units, ensure that you specify either LHH [left hand hinge], RHH [right hand hinge] or Double [units with vertical profiles on both sides] to ensure that the unit ordered is supplied with the correct gables.
  - > When using either a sink or hob, the distance behind the top rail profile to the back of the carcass is 534mm, therefore units may need to be pulled forward from the wall to accommodate your products.
- See our Verse Technical Guide for further details on this range. Alternatively, you can call our Furniture team for product information.

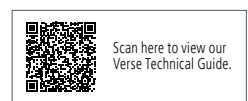

Scan here to view our Verse Technical Guide.

Note: Furniture codes beginning with the letter 'R' are assembled (rigid), by removing the 'R' the units are supplied unassembled (flat-pack).

VERSE

PRICE GROUP 3

**ENKO**



Special sizes available  
contact us for further information

Colours Options [PG3]: Black, Fern, Hunter, Indigo, Stone and Taupe.



HI-LINE BASE

Pull-Out

Shallow Base [300mm deep]

HI-LINE CORNER BASE

'L' Shaped

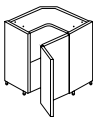
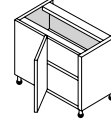
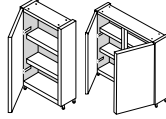
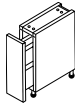
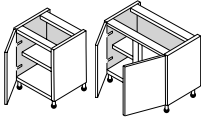

H:720mm CODE	WIDTH	CODE	WIDTH
RVBA15	150	RVBA60	600
RVBA26	260	RVBA70	700
RVBA30	300	RVBA80	800
RVBA35	350	RVBA90	900
RVBA40	400	RVBA10	1000
RVBA45	450	RVBA12	1200
RVBA50	500		

H:720mm CODE	WIDTH	H:720mm CODE	WIDTH
RVBISPO15	150	RVBSU30	300
Standard Mechanism inc.		RVBSU35	350
RVBKP015	150	RVBSU40	400
Kesseböhmer Mechanism inc.		RVBSU45	450
RVBKTP015	150	RVBSU50	500
Kesseböhmer Mechanism & Towel rail inc.		RVBSU60	600

H:720mm CODE	WIDTH	H:720mm CODE	WIDTH
RVBSU70	700	RVBAC830	800/300
RVBSU80	800	RVBAC80	800/400
RVBSU90	900	RVBAC845	800/450
RVBSU10	1000	RVBAC850	800/500
		RVBAC860	800/600
		RVBAC940	900/400
		RVBAC945	900/450

H:720mm CODE	WIDTH	H:720mm CODE	WIDTH
RVBAC950	900/500	RVBAC960	900/600
RVBAC960	900/600	RVBAC140	1000/400
RVBAC960	900/600	RVBAC145	1000/450
RVBAC960	900/600	RVBAC10	1000/500
RVBAC960	900/600	RVBAC120	1200/600

H:720mm CODE	WIDTH
VBAC90	900x900

Bi-fold hinge system Flatpack

Incl. Corner Post & Blanking Panel

BUILT UNDER OVEN

2 DRAWER BASE

3 DRAWER BASE

LOW WALL

MEDIUM WALL

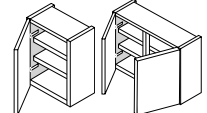
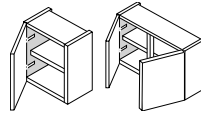
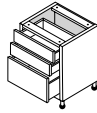
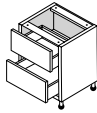
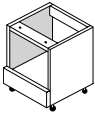

H:720mm CODE	WIDTH
RBUE060*	600

\*Non-verse spec.

H:720mm CODE	WIDTH	H:720mm CODE	WIDTH
RVBD230	300	RVBD330	300
RVBD240	400	RVBD340	400
RVBD250	500	RVBD350	500
RVBD260	600	RVBD360	600
RVBD280	800	RVBD380	800
RVBD290	900	RVBD390	900
RVBD210	1000	RVBD310	1000

2x325mm Drawers

H:720mm CODE	WIDTH	H:720mm CODE	WIDTH
RVBD330	300	RVWU30-5	300
RVBD340	400	RVWU40-5	400
RVBD350	500	RVWU45-5	450
RVBD360	600	RVWU50-5	500
RVBD380	800	RVWU60-5	600

2x160mm, 1x325mm Drawers

H:575mm CODE	WIDTH	D:300mm CODE	WIDTH
RVWU80-5	800	RVWU90-5	900
RVWU90-5	900	RVWU10-5	1000

H:720mm CODE	WIDTH	D:300mm CODE	WIDTH
RVWU26-7	260	RVWU60-7	600
RVWU30-7	300	RVWU70-7	700
RVWU35-7	350	RVWU80-7	800
RVWU40-7	400	RVWU90-7	900
RVWU45-7	450	RVWU10-7	1000
RVWU50-7	500		

Add 'X' to the end of the code for 350mm deep

Add 'X' to the end of the code for 350mm deep

MEDIUM WALL

TALL WALL

HORIZONTAL WALL

'L' Shaped Corner

Bi-Fold

Boiler

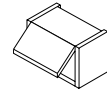
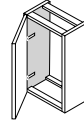
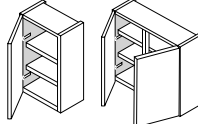
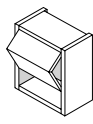
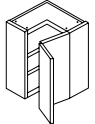

H:720mm CODE	D:300mm WIDTH
RCWL60-7	600x600

Add 'X' to the end of the code for 350mm deep [650x650]

Bi-Fold Hinge System

H:720mm CODE	D:300mm WIDTH	H:720mm CODE	D:300mm WIDTH
RVBFWU50-7	500	RVWU30-9	300
RVBFWU60-7	600	RVWU40-9	400
RVBFWU80-7	800	RVWU45-9	450
RVBFWU90-7	900	RVWU50-9	500
RVBFWU10-7	1000	RVWU60-9	600

H:900mm CODE	WIDTH	H:900mm CODE	WIDTH
RVWU80-9	800	RVWU80-9	800
RVWU90-9	900	RVWU10-9	1000

D:300mm CODE	WIDTH	H:900mm CODE	WIDTH
VBWU6040-9	600		

400mm deep Flatpack

H:290mm CODE	D:300mm WIDTH	H:360mm CODE	D:300mm WIDTH
RVHWU5029	500	RVHWU5036	500
RVHWU6029	600	RVHWU6036	600
RVHWU8029	800	RVHWU8036	800
RVHWU9029	900	RVHWU9036	900
RVHWU1029	1000	RVHWU1036	1000

Mechanism inc.  
Add 'X' to the end of the code for 350mm deep

Add 'X' to the end of the code for 350mm deep

All include Blum Aventos HKS System

Add 'X' to the end of the code for 350mm deep

MIDI UNITS

LARDER

PULL-OUT LARDER

INNER DRAWER LARDER

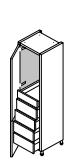
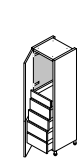
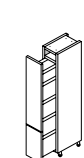
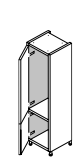
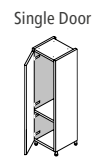
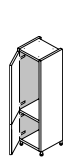
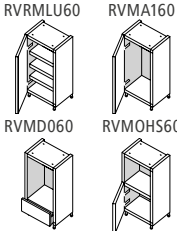

H:1250mm CODE	WIDTH
RVRMLU60	600
RVMA160	600
RVMD060	600
RVMOH560	600

H:1970mm CODE	WIDTH	H:1970mm CODE	WIDTH
RVTLU30	300	RVTLUSD50	500
RVTLU40	400	RVTLUSD60	600
RVTLU50	500		
RVTLU60	600		

H:1970mm CODE	WIDTH	H:2150mm CODE	WIDTH
RVETLU30	300	RVETLU40	400
RVETLU40	400	RVETLU50	500
RVETLU50	500	RVETLU60	600

H:1970mm CODE	WIDTH	H:2150mm CODE	WIDTH
RVTIPOL30	300	RVTKPOL30	300
RVTKPOL30	300	Standard Mechanism inc.	
RVETISPOL30*	300	RVETKPOL30*	300
RVETISPOL30*	300	Kesseböhmer Mechanism inc.	

H:1970mm CODE	WIDTH	H:1970mm CODE	WIDTH
RVTLID30	300	RVTLID40	400
RVTLID40	400	RVTLID50	500
RVTLID50	500	RVTLID60	600

H:2150mm CODE	WIDTH	H:2150mm CODE	WIDTH
RVETLID30	300	RVETLID40	400
RVETLID40	400	RVETLID50	500
RVETLID50	500	RVETLID60	600

1x Standard, 4x Deep Drawers

DOUBLE OVEN

SINGLE OVEN

SINGLE OVEN + COMPACT

COMPACT

FRIDGE + FRIDGE/FREEZER

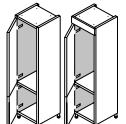
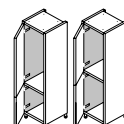
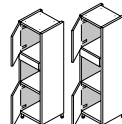
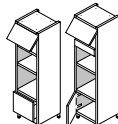
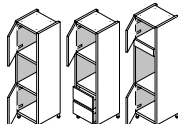
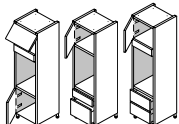

H:1970mm CODE	*H:2150mm WIDTH	H:1970mm CODE	*H:2150mm WIDTH
RVTOHD60	600	RVTOHS60	600
RVTOHDD60	600	RVTOHSD60	600
RVTOHDD60*	600	RVTOHS60*	600

H:1970mm CODE	*H:2150mm WIDTH	H:1970mm CODE	*H:2150mm WIDTH
RVTOHSC60	600	RVTOHSC60*	600

H:1970mm CODE	*H:2150mm WIDTH	H:1970mm CODE	*H:2150mm WIDTH
RVTOHC60	600	RVTOHC60*	600

H:1970mm CODE	*H:2150mm WIDTH	H:1970mm CODE	*H:2150mm WIDTH
RVTF160	600	RVTF260	600
RVTF460*	600	RVTF1U60*	600
RVTF1U60*	600	RVTF2U60*	600
RVTF4U60*	600	RVTF1U60*	600

\*Doors undrilled

H:1970mm CODE	*H:2150mm WIDTH	H:2150mm CODE	*H:2150mm WIDTH
RVTF160	600	RVTF160	600
RVTF260	600	RVTF260	600
RVTF1U60*	600	RVTF1U60*	600
RVTF2U60*	600	RVTF2U60*	600

\*For door on door appliances

H:1970mm CODE	*H:2150mm WIDTH	H:2150mm CODE	*H:2150mm WIDTH
RVTF160	600	RVTF160	600
RVTF260	600	RVTF260	600
RVTF1U60*	600	RVTF1U60*	600
RVTF2U60*	600	RVTF2U60*	600

\*For door on door appliances

END SUPPORT PANELS

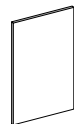

CODE	WIDTH
<b>ESP</b>	600
<b>900/700</b>	700

MFC Carcase

CARCASE MFC PANELS

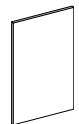

CODE	WXH
<b>1970/300</b>	300x1970
<b>2150/560</b>	560x2150
<b>2350/660</b>	660x2350
<b>720/300</b>	300x720
<b>900/2000</b>	2000x900
<b>900/300</b>	300x900

MFC Carcase

COMBI



CODE	WXH
<b>UG/**ET</b>	1000x22
<b>10ET/PM</b>	

Un-glued 1m Carcase Edging  
Un-glued Edging Tape 10mtr  
Door Finish

PLINTH

Universal Pelmet/Pilaster

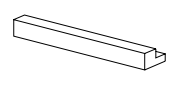

CODE	WXD
<b>UPCM/PM</b>	2740x55

Can also be used as a 36mm wide end post - rebated for plant-on end panels  
Door Finish

PLANT ON END PANELS

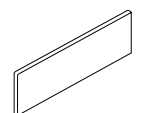

CODE	WIDTH
<b>PL</b>	2940
<b>PL/PM</b>	2740

Melamine [Carcase MFC]  
Door Finish

Clear Sealing Strip

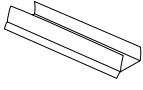

CODE	WIDTH
<b>PST</b>	3000

Door Finish

PLANT ON END PANELS

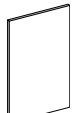

CODE	WXH
<b>2400/650/18PM</b>	650x2400
<b>900/350/18PM</b>	350x900
<b>900/650/18PM</b>	650x900

Door Finish

PLANT ON END PANELS

18mm Breakfast Bar Panel



CODE	WXH
<b>900/1200/18PM</b>	1200x900
<b>900/2400/18PM</b>	2400x900

Door Finish

FURNITURE ACCESSORIES

46mm Mitred End Panel

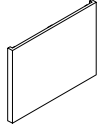

CODE	WXH
<b>MIEP9B/PM</b>	900x325
<b>MIEP9A/PM</b>	900x684
<b>MIEP12B/PM</b>	1160x325
<b>MIEP12A/PM</b>	1160x684

Door Finish

FURNITURE ACCESSORIES

Corner Post [Spare]

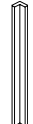

CODE	WIDTH
<b>CPTH/PM</b>	146

Flat panel for on site conversion

INTEGRATED DOORS

Undrilled

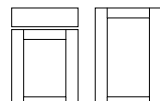

CODE	WXH
<b>INT4568</b>	446x684
<b>INT4571</b>	446x715
<b>INT6045</b>	596x450

SPARE DOOR FITTINGS

Hinges

[Hettich Soft Close]

CODE	DESCRIPTION
<b>SCHINGE90</b>	90 degree [Pair]
<b>SCHINGE170</b>	170 degree [Pair]

GENERAL ACCESSORIES

CODE	DESCRIPTION
<b>STPWN</b>	Set of 2 Door strapping plates
<b>LEGSET</b>	Set of 4 Adjustable legs

Stays [Blum Aventos]

CODE	DESCRIPTION
<b>BLSTAYHKS</b>	HK-S stay [Pair] * [inc mounting brackets]

GOLA PROFILES - STANDARD

Base Units

CODE	LENGTH
<b>NGPTOP**</b>	4100
<b>NGPMID**</b>	4100
<b>NGPFIXB</b>	
<b>NGPTOPCAP**</b>	
<b>NGPMIDCAP**</b>	

Wall Units

CODE	LENGTH
<b>NGPTOPEXT**</b>	
<b>NGPTOPINT**</b>	
<b>NGPMIDEXT**</b>	
<b>NGPMIDINT**</b>	
<b>NGPILCON</b>	

Wall Units

CODE	LENGTH
<b>NGPWALL**</b>	3900

Tall Units

CODE	LENGTH
<b>NGPVS**</b>	2250
<b>NGPVD**</b>	2250
<b>NGPFIXVS</b>	
<b>NGPFIXVD</b>	

CODE	DESCRIPTION
<b>NGPFIXVBKT</b>	Vertical rear fixing bracket [each] - 4 required per rail
<b>NGPAF580**</b>	Appliance filler 580mm



Standard colours - Matt Black [MB] and Anodised Steel [AS]

GOLA PROFILES - BESPOKE PAINTED - SOLID COLOURS

Base Units

CODE	LENGTH
<b>NGPTOP**</b>	3000
<b>NGPMID**</b>	3000
<b>NGPFIX10</b>	
<b>NGPTOPCAP**</b>	
<b>NGPMIDCAP**</b>	

Wall Units

CODE	LENGTH
<b>NGPTOPEXT**</b>	
<b>NGPTOPINT**</b>	
<b>NGPMIDEXT**</b>	
<b>NGPMIDINT**</b>	
<b>NGPILCON</b>	

Wall Units

CODE	LENGTH
<b>NGPWALL**</b>	3000

Tall Units

CODE	LENGTH
<b>NGPVS**</b>	2250
<b>NGPVD**</b>	2250
<b>NGPFIXVS</b>	
<b>NGPFIXVD</b>	

CODE	DESCRIPTION
<b>NGPFIXVBKT</b>	Vertical rear fixing bracket [each] - 4 required per rail
<b>NGPAF580**</b>	Appliance filler 580mm



Bespoke solid colours - Dark Blue [DB], Grey Blue [GB], Graphite [GR], Leaf [LF], Light Grey [LG], Luna [LU], Peacock [PC] and Stone Blue [SB]

GOLA PROFILES - BESPOKE PAINTED - SHIMMERING COLOURS

Base Units

CODE	LENGTH
<b>NGPTOP**</b>	3000
<b>NGPMID**</b>	3000
<b>NGPFIX10</b>	
<b>NGPTOPCAP**</b>	
<b>NGPMIDCAP**</b>	

Wall Units

CODE	LENGTH
<b>NGPTOPEXT**</b>	
<b>NGPTOPINT**</b>	
<b>NGPMIDEXT**</b>	
<b>NGPMIDINT**</b>	
<b>NGPILCON</b>	

Tall Units

CODE	LENGTH
<b>NGPVS**</b>	2250
<b>NGPVD**</b>	2250
<b>NGPFIXVS</b>	
<b>NGPFIXVD</b>	

CODE	DESCRIPTION
<b>NGPFIXVBKT</b>	Vertical rear fixing bracket [each] - 4 required per rail
<b>NGPAF580**</b>	Appliance filler 580mm



Bespoke Shimmering Colours - Gold Dust [GD] and Rose Gold [RG]

- > When installing an integrated under counter appliance, please check the appliance height carefully to establish if it will fit below the top profile [812mm high or less]. The plinth height can be raised slightly to accommodate taller appliances.
  - > If using free-standing appliances, end panels must be fitted either side of the appliance and the rail profile finishes against the panel, and end caps fitted if required.
  - > A top rail profile cannot be used with a built-under single oven in the Verse range. The rails must stop on each side of the appliance and end caps fitted.
  - > When using a 'L' shaped corner wall unit, the Verse wall rail will need to be mitred on site.
  - > When planning ensure a 30mm gap is left between, or to the side of all Midi & Tall housings for the vertical profile to be fitted.
  - > When ordering Midi and Tall units, ensure that you specify either LHH [left hand hinge], RHH [right hand hinge] or Double [units with vertical profiles on both sides] to ensure that the unit ordered is supplied with the correct gables.
  - > When using either a sink or hob, the distance behind the top rail profile to the back of the carcass is 534mm, therefore units may need to be pulled forward from the wall to accommodate your products.
- See our Verse Technical Guide for further details on this range. Alternatively, you can call our Furniture team for product information.



Scan here to view our Verse Technical Guide.



VERSE

PRICE GROUP 1

**EPOS**



Special sizes available  
contact us for further information

Colours Options [PG1]: Slate



HI-LINE BASE

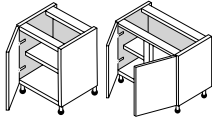

Pull-Out

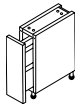

Shallow Base [300mm deep]

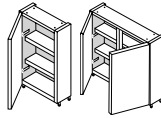

HI-LINE CORNER BASE

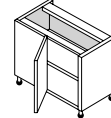

'L' Shaped

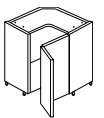

H:720mm CODE	WIDTH	CODE	WIDTH
RVBA15	150	RVBA60	600
RVBA26	260	RVBA70	700
RVBA30	300	RVBA80	800
RVBA35	350	RVBA90	900
RVBA40	400	RVBA10	1000
RVBA45	450	RVBA12	1200
RVBA50	500		

H:720mm CODE	WIDTH	H:720mm CODE	WIDTH
RVBISPO15	150	RVBSBU30	300
Standard Mechanism inc.		RVBSBU35	350
RVBKP015	150	RVBSBU40	400
Kesseböhmer Mechanism inc.		RVBSBU45	450
RVBKTP015	150	RVBSBU50	500
Kesseböhmer Mechanism & Towel rail inc.		RVBSBU60	600

H:720mm CODE	WIDTH	H:720mm CODE	WIDTH
RVBSBU70	700	RVBAC830	800/300
RVBSBU80	800	RVBAC80	800/400
RVBSBU90	900	RVBAC845	800/450
RVBSBU10	1000	RVBAC140	1000/400
		RVBAC850	800/500
		RVBAC860	800/600
		RVBAC940	900/400
		RVBAC945	900/450

H:720mm CODE	WIDTH	H:720mm CODE	WIDTH
RVBAC950	900/500	RVBAC960	900/600
RVBAC960	900/600	RVBAC145	1000/450
RVBAC140	1000/400	RVBAC10	1000/500
RVBAC145	1000/450	RVBAC160	1000/600
RVBAC10	1000/500	RVBAC12	1200/600

H:720mm CODE	WIDTH
VBAC90	900x900

Bi-fold hinge system Flatpack

Incl. Corner Post & Blanking Panel

BUILT UNDER OVEN

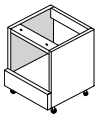

H:720mm CODE	WIDTH
RBUE060*	600

\*Non-verse spec.

2 DRAWER BASE



H:720mm CODE	WIDTH
RVBD230	300
RVBD240	400
RVBD250	500
RVBD260	600
RVBD280	800
RVBD290	900
RVBD210	1000

2x325mm Drawers

3 DRAWER BASE

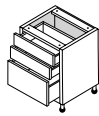

H:720mm CODE	WIDTH
RVBD330	300
RVBD340	400
RVBD350	500
RVBD360	600
RVBD380	800
RVBD390	900
RVBD310	1000

2x160mm, 1x325mm Drawers

LOW WALL

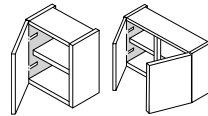

H:575mm CODE	WIDTH	D:300mm CODE	WIDTH
RVWU30-5	300	RVWU80-5	800
RVWU40-5	400	RVWU90-5	900
RVWU45-5	450	RVWU10-5	1000
RVWU50-5	500		
RVWU60-5	600		

Add 'X' to the end of the code for 350mm deep

MEDIUM WALL

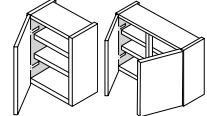

H:720mm CODE	WIDTH	H:720mm CODE	WIDTH
RVWU26-7	260	RVWU60-7	600
RVWU30-7	300	RVWU70-7	700
RVWU35-7	350	RVWU80-7	800
RVWU40-7	400	RVWU90-7	900
RVWU45-7	450	RVWU10-7	1000
RVWU50-7	500		

Add 'X' to the end of the code for 350mm deep

MEDIUM WALL

'L' Shaped Corner

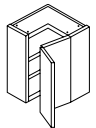

H:720mm CODE	D:300mm WIDTH
RVCW160-7	600x600

Add 'X' to the end of the code for 350mm deep [650x650]  
Bi-Fold Hinge System

Bi-Fold

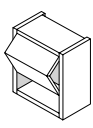

H:720mm CODE	D:300mm WIDTH
RVBFWU50-7	500
RVBFWU60-7	600
RVBFWU80-7	800
RVBFWU90-7	900
RVBFWU10-7	1000

Mechanism inc.  
Add 'X' to the end of the code for 350mm deep

TALL WALL

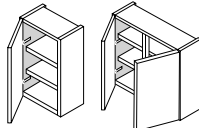

H:900mm CODE	WIDTH	D:300mm CODE	WIDTH
RVWU30-9	300	RVWU80-9	800
RVWU40-9	400	RVWU90-9	900
RVWU45-9	450	RVWU10-9	1000
RVWU50-9	500		
RVWU60-9	600		

Add 'X' to the end of the code for 350mm deep

Boiler

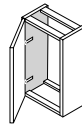

H:900mm CODE	WIDTH
VBWU6040-9	600

400mm deep  
Flatpack

HORIZONTAL WALL

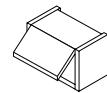

H:290mm CODE	D:300mm WIDTH	H:360mm CODE	D:300mm WIDTH
RVHWU5029	500	RVHWU5036	500
RVHWU6029	600	RVHWU6036	600
RVHWU8029	800	RVHWU8036	800
RVHWU9029	900	RVHWU9036	900
RVHWU1029	1000	RVHWU1036	1000

All include Blum Aventos HKS System

Add 'X' to the end of the code for 350mm deep

MIDI UNITS

RVRLU60 RVMA160

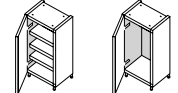

H:1250mm CODE	WIDTH
RVMD060	600
RVMOHS60	600

LARDER

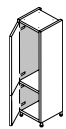

H:1970mm CODE	WIDTH
RVTLU30	300
RVTLU40	400
RVTLU50	500
RVTLU60	600

Single Door

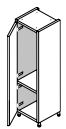

H:1970mm CODE	WIDTH
RVTLUSD50	500
RVTLUSD60	600

H:2150mm CODE	WIDTH
RVETLU30	300
RVETLU40	400
RVETLU50	500
RVETLU60	600

PULL-OUT LARDER

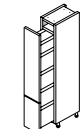

H:1970mm CODE	*H:2150mm WIDTH
RVTISPOL30	300
RVTKPOL30	300

Standard Mechanism inc.  
RVETISPOL30\* 300  
RVETKPOL30\* 300  
Kesseböhmer Mechanism inc.

INNER DRAWER LARDER

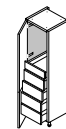

H:1970mm CODE	WIDTH
RVTLID30	300
RVTLID40	400
RVTLID50	500
RVTLID60	600

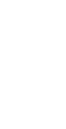

H:2150mm CODE	WIDTH
RVETLID30	300
RVETLID40	400
RVETLID50	500
RVETLID60	600

1x Standard, 4x Deep Drawers

DOUBLE OVEN

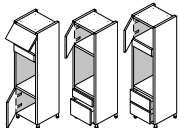

H:1970mm CODE	*H:2150mm WIDTH
RVTOHD60	600
RVTOHDD60	600
RVTOHDD60*	600

SINGLE OVEN

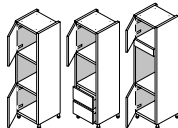

H:1970mm CODE	*H:2150mm WIDTH
RVTOHS60	600
RVTOHSD60	600
RVTOHS60*	600

SINGLE OVEN + COMPACT

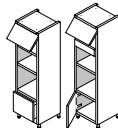

H:1970mm CODE	*H:2150mm WIDTH
RVTOHSC60	600
RVTOHSC60*	600

COMPACT

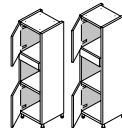

H:1970mm CODE	*H:2150mm WIDTH
RVTOHC60	600
RVETOHC60*	600

FRIDGE + FRIDGE/FREEZER

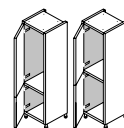

H:1970mm CODE	WIDTH
RVTF160	600
RVTF460*	600
RVTF160*	600
RVTF460*	600

\*Doors undrilled  
\*For door on door appliances



H:2150mm CODE	WIDTH
RVTF160	600
RVTF260	600
RVTF160*	600
RVTF260*	600

\*For door on door appliances

END SUPPORT PANELS

CARCASE MFC PANELS

PLINTH

PLANT ON END PANELS

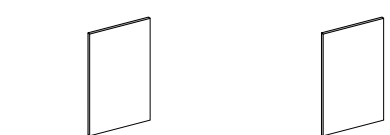

H:900mm	CODE	WIDTH	CODE	WXH
	<b>ESP</b>	600	<b>1970/300</b>	300x1970
	<b>900/700</b>	700	<b>2150/560</b>	560x2150
MFC Carcase			<b>2350/660</b>	660x2350
			<b>720/300</b>	300x720
			<b>900/2000</b>	2000x900
			<b>900/300</b>	300x900



CODE	WXH
<b>UG/**ET</b>	1000x22

Un-Glued 1m Carcase Edging

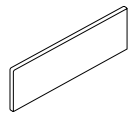

H:150mm	CODE	WIDTH
	<b>PL</b>	2940

Melamine [Carcase MFC]  
Door Finish



Clear Sealing Strip

18mm

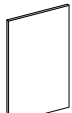

CODE	WXH
<b>2400/650/18PSL</b>	650x2400
<b>900/350/18PSL</b>	350x900
<b>900/650/18PSL</b>	650x900

Door Finish

PLANT ON END PANELS

18mm Breakfast Bar Panel

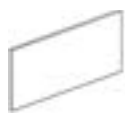

CODE	WXH
<b>900/1200/18PSL</b>	1200x900

Door Finish

46mm Mitred End Panel

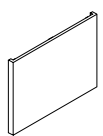

CODE	WXH
<b>MIEP9B/PSL</b>	900x325
<b>MIEP9A/PSL</b>	900x684
<b>MIEP12B/PSL</b>	1160x325
<b>MIEP12A/PSL</b>	1160x684

Door Finish

FURNITURE ACCESSORIES

Corner Post [Spare]



H:684mm	CODE	WIDTH
	<b>CPTH/PSL</b>	146

Flat panel for on site conversion

INTEGRATED DOORS

Undrilled

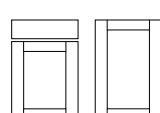

CODE	WXH	CODE	WXH
<b>INT4568</b>	446x684	<b>INT6068</b>	596x684
<b>INT4571</b>	446x715	<b>INT6071</b>	596x715
<b>INT6045</b>	596x450		

SPARE DOOR FITTINGS

Hinges [Hettich Soft Close]

CODE	DESCRIPTION
<b>SCHINGE90</b>	90 degree [Pair]
<b>SCHINGE170</b>	170 degree [Pair]

GENERAL ACCESSORIES

CODE	DESCRIPTION
<b>STPWN</b>	Set of 2 Door strapping plates
<b>LEGSET</b>	Set of 4 Adjustable legs

Stays [Blum Aventos]

CODE	DESCRIPTION
<b>BLSTAYHKS</b>	HK-S stay [Pair] * [inc mounting brackets]

GOLA PROFILES - STANDARD

Base Units

CODE	LENGTH
<b>NGPTOP**</b>	4100
Top profile	
<b>NGPMID**</b>	4100
Mid profile	
<b>NGPFIXB</b>	
Fixing brackets [pack 10]	
<b>NGPTOPCAP**</b>	
Top profile end caps [Pr]	
<b>NGPMIDCAP**</b>	
Mid profile end caps [Pr]	

Wall Units

CODE	LENGTH
<b>NGPWALL**</b>	3900

Tall Units

CODE	LENGTH	DESCRIPTION
<b>NGPVS**</b>	2250	Vertical single profile
<b>NGPVD**</b>	2250	Vertical double profile
<b>NGPFIXVS</b>		Vertical SINGLE fixing [each] - 4 required per rail
<b>NGPFIXVD</b>		Vertical DOUBLE fixing [each] - 4 required per rail
<b>NGPFIXVBKT</b>		Vertical rear fixing bracket [each] - 4 required per rail
<b>NGPAF580**</b>		Appliance filler 580mm



Standard colours - Matt Black [MB] and Anodised Steel [AS]

GOLA PROFILES - BESPOKE PAINTED - SOLID COLOURS

Base Units

CODE	LENGTH
<b>NGPTOP**</b>	3000
Top profile	
<b>NGPMID**</b>	3000
Mid profile	
<b>NGPFIX10</b>	
Fixing brackets [pack 10]	
<b>NGPTOPCAP**</b>	
Top profile end caps [Pr]	
<b>NGPMIDCAP**</b>	
Mid profile end caps [Pr]	

Wall Units

CODE	LENGTH
<b>NGPWALL**</b>	3000

Tall Units

CODE	LENGTH	DESCRIPTION
<b>NGPVS**</b>	2250	Vertical single profile
<b>NGPVD**</b>	2250	Vertical double profile
<b>NGPFIXVS</b>		Vertical SINGLE fixing [each] - 4 required per rail
<b>NGPFIXVD</b>		Vertical DOUBLE fixing [each] - 4 required per rail
<b>NGPFIXVBKT</b>		Vertical rear fixing bracket [each] - 4 required per rail
<b>NGPAF580**</b>		Appliance filler 580mm



Bespoke solid colours - Dark Blue [DB], Grey Blue [GB], Graphite [GR], Leaf [LF], Light Grey [LG], Luna [LU], Peacock [PC] and Stone Blue [SB]

GOLA PROFILES - BESPOKE PAINTED - SHIMMERING COLOURS

Base Units

CODE	LENGTH
<b>NGPTOP**</b>	3000
Top profile	
<b>NGPMID**</b>	3000
Mid profile	
<b>NGPFIX10</b>	
Fixing brackets [pack 10]	
<b>NGPTOPCAP**</b>	
Top profile end caps [Pr]	
<b>NGPMIDCAP**</b>	
Mid profile end caps [Pr]	

Wall Units

CODE	LENGTH
<b>NGPWALL**</b>	3000

Tall Units

CODE	LENGTH	DESCRIPTION
<b>NGPVS**</b>	2250	Vertical single profile
<b>NGPVD**</b>	2250	Vertical double profile
<b>NGPFIXVS</b>		Vertical SINGLE fixing [each] - 4 required per rail
<b>NGPFIXVD</b>		Vertical DOUBLE fixing [each] - 4 required per rail
<b>NGPFIXVBKT</b>		Vertical rear fixing bracket [each] - 4 required per rail
<b>NGPAF580**</b>		Appliance filler 580mm



Bespoke Shimmering Colours - Gold Dust [GD] and Rose Gold [RG]

- > When installing an integrated under counter appliance, please check the appliance height carefully to establish if it will fit below the top profile [812mm high or less]. The plinth height can be raised slightly to accommodate taller appliances.
  - > If using free-standing appliances, end panels must be fitted either side of the appliance and the rail profile finishes against the panel, and end caps fitted if required.
  - > A top rail profile cannot be used with a built-under single oven in the Verse range. The rails must stop on each side of the appliance and end caps fitted.
  - > When using a 'L' shaped corner wall unit, the Verse wall rail will need to be mitred on site.
  - > When planning ensure a 30mm gap is left between, or to the side of all Midi & Tall housings for the vertical profile to be fitted.
  - > When ordering Midi and Tall units, ensure that you specify either LHH [left hand hinge], RHH [right hand hinge] or Double [units with vertical profiles on both sides] to ensure that the unit ordered is supplied with the correct gables.
  - > When using either a sink or hob, the distance behind the top rail profile to the back of the carcase is 534mm, therefore units may need to be pulled forward from the wall to accommodate your products.
- See our Verse Technical Guide for further details on this range. Alternatively, you can call our Furniture team for product information.

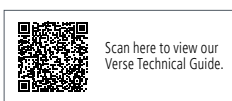

Scan here to view our Verse Technical Guide.

Note: Furniture codes beginning with the letter 'R' are assembled (rigid), by removing the 'R' the units are supplied unassembled (flat-pack).



VERSE

PRICE GROUP 3

# JUKO MATT



Special sizes available  
contact us for further information

Colours Options [PG3]: Ash, Cloud and Graphite.



## HI-LINE BASE

Pull-Out

Shallow Base [300mm deep]

## HI-LINE CORNER BASE

'L' Shaped

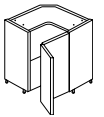
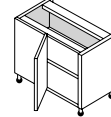
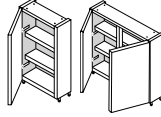
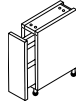
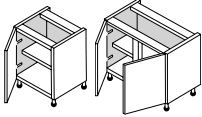

H:720mm CODE	WIDTH	CODE	WIDTH
RVBA15	150	RVBA70	700
RVBA30	300	RVBA80	800
RVBA35	350	RVBA90	900
RVBA40	400	RVBA10	1000
RVBA45	450	RVBA12	1200
RVBA50	500		
RVBA60	600		

H:720mm CODE	WIDTH	H:720mm CODE	WIDTH
RVBISO15	150	RVBISO15	150
Standard Mechanism inc.		Kesseböhmer Mechanism inc.	
RVBKPO15	150	RVBKTP015	150
Kesseböhmer Mechanism inc.		Kesseböhmer Mechanism & Towel rail inc.	

H:720mm CODE	WIDTH	H:720mm CODE	WIDTH
RVSBU30	300	RVSBU70	700
RVSBU35	350	RVSBU80	800
RVSBU40	400	RVSBU90	900
RVSBU45	450	RVSBU10	1000
RVSBU50	500		
RVSBU60	600		

H:720mm CODE	WIDTH	H:720mm CODE	WIDTH
RVBAC830	800/300	RVBAC950	900/500
RVBAC80	800/400	RVBAC960	900/600
RVBAC845	800/450	RVBAC140	1000/400
RVBAC850	800/500	RVBAC145	1000/450
RVBAC860	800/600	RVBAC10	1000/500
RVBAC940	900/400	RVBAC160	1000/600
RVBAC945	900/450	RVBAC12	1200/600

H:720mm CODE	WIDTH	H:720mm CODE	WIDTH
VBAC90	900x900	Bi-fold hinge system Flatpack	

Inc. Corner Post & Blanking Panel

## BUILT UNDER OVEN

## 2 DRAWER BASE

## 3 DRAWER BASE

## LOW WALL

## MEDIUM WALL

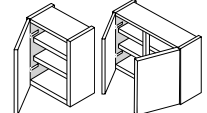
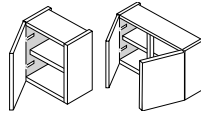
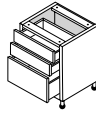
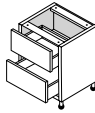
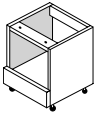

H:720mm CODE	WIDTH
RBUE060*	600

\*Non-verse spec.

H:720mm CODE	WIDTH	H:720mm CODE	WIDTH
RVBD250	500	RVBD260	600
RVBD280	800	RVBD290	900
RVBD210	1000		

2x325mm Drawers

H:720mm CODE	WIDTH	H:720mm CODE	WIDTH
RVBD350	500	RVBD360	600
RVBD380	800	RVBD390	900
RVBD310	1000		

2x160mm, 1x325mm Drawers

H:575mm CODE	WIDTH	H:575mm CODE	WIDTH
RVWU30-5	300	RVWU40-5	400
RVWU45-5	450	RVWU50-5	500
RVWU60-5	600		

D:300mm CODE	WIDTH	D:300mm CODE	WIDTH
RVWU80-5	800	RVWU90-5	900
RVWU10-5	1000		

H:720mm CODE	WIDTH	H:720mm CODE	WIDTH
RVWU26-7	260	RVWU30-7	300
RVWU35-7	350	RVWU40-7	400
RVWU45-7	450	RVWU50-7	500
RVWU60-7	600	RVWU70-7	700
RVWU80-7	800	RVWU90-7	900
RVWU10-7	1000		

Add 'X' to the end of the code for 350mm deep

Add 'X' to the end of the code for 350mm deep

## MEDIUM WALL

## TALL WALL

## HORIZONTAL WALL

'L' Shaped Corner

Bi-Fold

Boiler

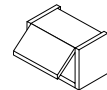
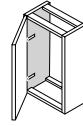
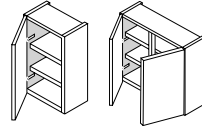
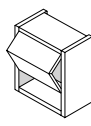
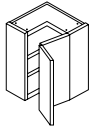

H:720mm CODE	D:300mm WIDTH
RVCL60-7	600x600

Add 'X' to the end of the code for 350mm deep [650x650]

Bi-Fold Hinge System

H:720mm CODE	D:300mm WIDTH	H:720mm CODE	D:300mm WIDTH
RVBFWU50-7	500	RVBFWU60-7	600
RVBFWU80-7	800	RVBFWU90-7	900
RVBFWU10-7	1000		

Mechanism inc.  
Add 'X' to the end of the code for 350mm deep

H:900mm CODE	D:300mm WIDTH	H:900mm CODE	D:300mm WIDTH
RVWU30-9	300	RVWU40-9	400
RVWU45-9	450	RVWU50-9	500
RVWU60-9	600		

Add 'X' to the end of the code for 350mm deep

H:900mm CODE	D:300mm WIDTH
VBWU6040-9	600

400mm deep Flatpack

H:290mm CODE	D:300mm WIDTH	H:360mm CODE	D:300mm WIDTH
RVHWU5029	500	RVHWU5036	500
RVHWU6029	600	RVHWU6036	600
RVHWU8029	800	RVHWU8036	800
RVHWU9029	900	RVHWU9036	900
RVHWU1029	1000	RVHWU1036	1000

All include Blum Aventos HKS System

Add 'X' to the end of the code for 350mm deep

## MIDI UNITS

## LARDER

## PULL-OUT LARDER

## INNER DRAWER LARDER

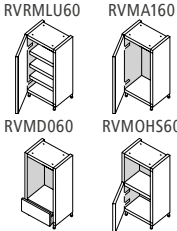

H:1250mm CODE	WIDTH
RVRMLU60	600
RVMA160	600
RVMD060	600
RVMOH560	600

H:1970mm CODE	WIDTH	H:1970mm CODE	WIDTH
RVTLU30	300	RVTLU40	400
RVTLU50	500	RVTLU60	600

H:1970mm CODE	WIDTH	H:1970mm CODE	WIDTH
RVTLUSD50	500	RVTLUSD60	600

H:2150mm CODE	WIDTH	H:2150mm CODE	WIDTH
RVETLU30	300	RVETLU40	400
RVETLU50	500	RVETLU60	600

H:1970mm CODE	*H:2150mm WIDTH
RVTIPOL30	300
RVTKPOL30	300
Standard Mechanism inc.	
RVETISPOL30*	300
RVETKPOL30*	300

Kesseböhmer Mechanism inc.

H:1970mm CODE	WIDTH	H:1970mm CODE	WIDTH
RVTLID30	300	RVTLID40	400
RVTLID50	500	RVTLID60	600

H:2150mm CODE	WIDTH	H:2150mm CODE	WIDTH
RVETLID30	300	RVETLID40	400
RVETLID50	500	RVETLID60	600

1x Standard, 4x Deep Drawers

## DOUBLE OVEN

## SINGLE OVEN

## SINGLE OVEN + COMPACT

## COMPACT

## FRIDGE + FRIDGE/FREEZER

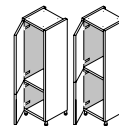
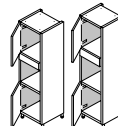
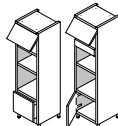
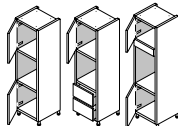
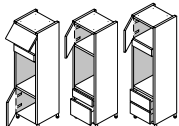

H:1970mm CODE	*H:2150mm WIDTH	H:1970mm CODE	*H:2150mm WIDTH
RVTOHD60	600	RVTOHS60	600
RVTOHDD60	600	RVTOHSD60	600
RVTOHDD60*	600	RVTOHS60*	600

H:1970mm CODE	*H:2150mm WIDTH	H:1970mm CODE	*H:2150mm WIDTH
RVTOHSC60	600	RVTOHSC60*	600

H:1970mm CODE	*H:2150mm WIDTH	H:1970mm CODE	*H:2150mm WIDTH
RVTOHC60	600	RVTOHC60*	600

H:1970mm CODE	*H:2150mm WIDTH	H:1970mm CODE	*H:2150mm WIDTH
RVTFFF1/60	600	RVTFFF2/60	600
RVTFFF4/60*	600	RVTFFF1U/60*	600
RVTFFF1U/60*	600	RVTFFF2U/60*	600
RVTFFF4U/60*	600		

H:2150mm CODE	WIDTH	H:2150mm CODE	WIDTH
RVETFF1/60	600	RVETFF2/60	600
RVETFF1U/60*	600	RVETFF2U/60*	600

H:2150mm CODE	WIDTH	H:2150mm CODE	WIDTH
RVETFF1/60	600	RVETFF2/60	600
RVETFF1U/60*	600	RVETFF2U/60*	600

\*For door on door appliances

\*For door on door appliances

END SUPPORT PANELS

CARCASE MFC PANELS

COMBI

PLINTH

PLANT ON END PANELS

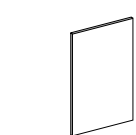

CODE	WIDTH
ESP	600
900/700	700

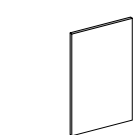

CODE	WXH
1970/300	300x1970
2150/560	560x2150
2350/660	660x2350
720/300	300x720
900/2000	2000x900
900/300	300x900



CODE	WXH
UG/**ET	1000x22

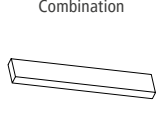

CODE	WIDTH
PCM/BM	3000

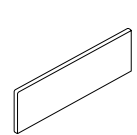

CODE	WIDTH
PL	2940
PL/BM	2440



CODE	WIDTH
PST	3000

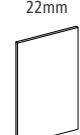

CODE	WXH
2440/350/22BM	350x2440
2440/650/22BM	650x2440
900/650/22BM	650x900
950/350/22BM	350x950

PLANT ON END PANELS

22mm Breakfast Bar Panel



CODE	WXH
910/1185/22BM	1185x910
900/2400/22BM	2400x900

50mm Mitred End Panel

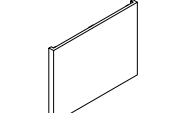

CODE	WXH
MBEPA/BM	604x684
MIEP9A/BM	908x684
MIEP12A/BM	1168x684

FURNITURE ACCESSORIES

Corner Post (Spare)

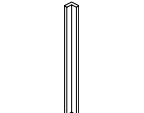

CODE	WIDTH
CPTH/BM	60

INTEGRATED DOORS

Undrilled

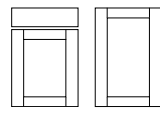

CODE	WXH	CODE	WXH
INT4568	446x684	INT6068	596x684
INT4571	446x715	INT6071	596x715
INT6045	596x450		

SPARE DOOR FITTINGS

Hinges [Hettich Soft Close]

CODE
SCHINGE90
SCHINGE170

GENERAL ACCESSORIES

CODE	Description
STPWN	Door strapping plates
LEGSET	Adjustable legs
PCC/BM	Painted care kit

GOLA PROFILES - STANDARD

Base Units

CODE	LENGTH
NGPTOP**	4100
NGPMID**	4100
NGPFIXB	
NGPTOPCAP**	
NGPMIDCAP**	

Wall Units

CODE	LENGTH
NGPWALL**	3900

Tall Units

CODE	LENGTH	CODE	LENGTH
NGPVS**	2250	NGPFIXVBKT	
NGPVD**	2250	NGPAF580**	
NGPFIXVS			
NGPFIXVD			



Standard colours - Matt Black [MB] and Anodised Steel [AS]

GOLA PROFILES - BESPOKE PAINTED - SOLID COLOURS

Base Units

CODE	LENGTH
NGPTOP**	3000
NGPMID**	3000
NGPFIX10	
NGPTOPCAP**	
NGPMIDCAP**	

Wall Units

CODE	LENGTH
NGPWALL**	3000

Tall Units

CODE	LENGTH	CODE	LENGTH
NGPVS**	2250	NGPFIXVBKT	
NGPVD**	2250	NGPAF580**	
NGPFIXVS			
NGPFIXVD			



Bespoke solid colours - Dark Blue [DB], Grey Blue [GB], Graphite [GR], Leaf [LF], Light Grey [LG], Luna [LU], Peacock [PC] and Stone Blue [SB]

GOLA PROFILES - BESPOKE PAINTED - SHIMMERING COLOURS

Base Units

CODE	LENGTH
NGPTOP**	3000
NGPMID**	3000
NGPFIX10	
NGPTOPCAP**	
NGPMIDCAP**	

Wall Units

CODE	LENGTH
NGPWALL**	3000

Tall Units

CODE	LENGTH	CODE	LENGTH
NGPVS**	2250	NGPFIXVBKT	
NGPVD**	2250	NGPAF580**	
NGPFIXVS			
NGPFIXVD			



Bespoke Shimmering Colours - Gold Dust [GD] and Rose Gold [RG]

- > When installing an integrated under counter appliance, please check the appliance height carefully to establish if it will fit below the top profile [812mm high or less]. The plinth height can be raised slightly to accommodate taller appliances.
- > If using free-standing appliances, end panels must be fitted either side of the appliance and the rail profile finishes against the panel, and end caps fitted if required.
- > A top rail profile cannot be used with a built-under single oven in the Verse range. The rails must stop on each side of the appliance and end caps fitted.
- > When using a 'L' shaped corner wall unit, the Verse wall rail will need to be mitred on site.
- > When planning ensure a 30mm gap is left between, or to the side of all Midi & Tall housings for the vertical profile to be fitted.
- > When ordering Midi and Tall units, ensure that you specify either LHH [left hand hinge], RHH [right hand hinge] or Double [units with vertical profiles on both sides] to ensure that the unit ordered is supplied with the correct gables.
- > When using either a sink or hob, the distance behind the top rail profile to the back of the carcass is 534mm, therefore units may need to be pulled forward from the wall to accommodate your products.



Scan here to view our Verse Technical Guide.

Note: Furniture codes beginning with the letter 'R' are assembled (rigid), by removing the 'R' the units are supplied unassembled (flat-pack).

VERSE

PRICE GROUP 2

# KOLT

Special sizes available  
contact us for further information

Colours Options [PG2]: Ash Marble, Copper Blend, Dark Oak, Graphite Blend, Grey Blend, Grey Marble, Lead Marble, Natural Oak, and White Oak.



## HI-LINE BASE

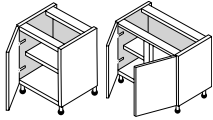

H:720mm CODE	WIDTH	CODE	WIDTH
RVBA15	150	RVBA60	600
RVBA26	260	RVBA70	700
RVBA30	300	RVBA80	800
RVBA35	350	RVBA90	900
RVBA40	400	RVBA10	1000
RVBA45	450	RVBA12	1200
RVBA50	500		

## Pull-Out

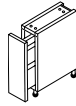

H:720mm CODE	WIDTH	CODE	WIDTH
RVBISPO15	150	RVBKPO15	150
RVBSBU30	300	RVBKTP015	150
RVBSBU35	350		
RVBSBU40	400		
RVBSBU45	450		
RVBSBU50	500		
RVBSBU60	600		

## Shallow Base [300mm deep]

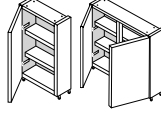

H:720mm CODE	WIDTH	CODE	WIDTH
RVSBU70	700	RVSBU80	800
RVSBU80	800	RVSBU90	900
RVSBU90	900	RVSBU10	1000

## HI-LINE CORNER BASE

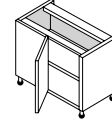

H:720mm CODE	WIDTH	CODE	WIDTH
RVBAC830	800/300	RVBAC950	900/500
RVBAC80	800/400	RVBAC960	900/600
RVBAC845	800/450	RVBAC140	1000/400
RVBAC850	800/500	RVBAC145	1000/450
RVBAC860	800/600	RVBAC10	1000/500
RVBAC940	900/400	RVBAC160	1000/600
RVBAC945	900/450	RVBAC12	1200/600

## 'L' Shaped

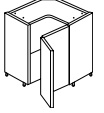

H:720mm CODE	WIDTH	CODE	WIDTH
VBAC90	900x900		

Inc. Corner Post & Blanking Panel

## BUILT UNDER OVEN

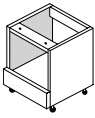

H:720mm CODE	WIDTH
RBUE06*	600

\*Non-verse spec.

## 2 DRAWER BASE

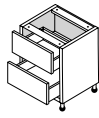

H:720mm CODE	WIDTH	CODE	WIDTH
RVBD230	300	RVBD240	400
RVBD250	500	RVBD260	600
RVBD280	800	RVBD290	900
RVBD210	1000		

2x325mm Drawers

## 3 DRAWER BASE

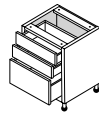

H:720mm CODE	WIDTH	CODE	WIDTH
RVBD330	300	RVBD340	400
RVBD350	500	RVBD360	600
RVBD380	800	RVBD390	900
RVBD310	1000		

2x160mm, 1x325mm Drawers

## LOW WALL

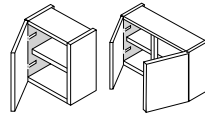

H:575mm CODE	WIDTH	D:300mm CODE	WIDTH
RVWU30-5	300	RVWU80-5	800
RVWU40-5	400	RVWU90-5	900
RVWU45-5	450	RVWU10-5	1000
RVWU50-5	500		
RVWU60-5	600		

Add 'X' to the end of the code for 350mm deep

## MEDIUM WALL

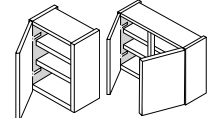

H:720mm CODE	WIDTH	CODE	WIDTH
RVWU26-7	260	RVWU60-7	600
RVWU30-7	300	RVWU70-7	700
RVWU35-7	350	RVWU80-7	800
RVWU40-7	400	RVWU90-7	900
RVWU45-7	450	RVWU10-7	1000
RVWU50-7	500		

Add 'X' to the end of the code for 350mm deep

## MEDIUM WALL

### 'L' Shaped Corner

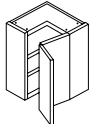

H:720mm CODE	D:300mm WIDTH
RVCWL60-7	600x600

Add 'X' to the end of the code for 350mm deep [650x650]

Bi-Fold Hinge System

### Bi-Fold

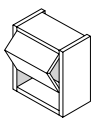

H:720mm CODE	D:300mm WIDTH	H:900mm CODE	WIDTH
RVBFWU50-7	500	RVWU30-9	300
RVBFWU60-7	600	RVWU40-9	400
RVBFWU80-7	800	RVWU45-9	450
RVBFWU90-7	900	RVWU50-9	500
RVBFWU10-7	1000	RVWU60-9	600

Mechanism inc.  
Add 'X' to the end of the code for 350mm deep

## TALL WALL

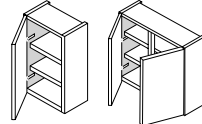

H:900mm CODE	WIDTH	D:300mm CODE	WIDTH
RVWU80-9	800	RVWU80-9	800
RVWU90-9	900	RVWU90-9	900
RVWU10-9	1000	RVWU10-9	1000

Add 'X' to the end of the code for 350mm deep

### Boiler

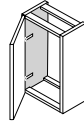

H:900mm CODE	WIDTH
VBWU6040-9	600

400mm deep  
Flatpack

## HORIZONTAL WALL

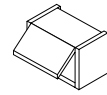

H:290mm CODE	D:300mm WIDTH	H:360mm CODE	D:300mm WIDTH
RVHWU5029	500	RVHWU5036	500
RVHWU6029	600	RVHWU6036	600
RVHWU8029	800	RVHWU8036	800
RVHWU9029	900	RVHWU9036	900
RVHWU1029	1000	RVHWU1036	1000

All include Blum Aventos HKS System  
Add 'X' to the end of the code for 350mm deep

## MIDI UNITS

RVRMLU60 RVMA160

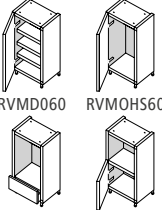

H:1250mm CODE	WIDTH
RVRMLU60	600
RVMA160	600
RVMD060	600
RVMOHS60	600

## LARDER

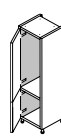

H:1970mm CODE	WIDTH	H:1970mm CODE	WIDTH
RVTLU30	300	RVTLUSD50	500
RVTLU40	400	RVTLUSD60	600
RVTLU50	500		
RVTLU60	600		

### Single Door

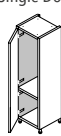

H:1970mm CODE	WIDTH	H:2150mm CODE	WIDTH
RVETLU30	300	RVETLU30	300
RVETLU40	400	RVETLU40	400
RVETLU50	500	RVETLU50	500
RVETLU60	600	RVETLU60	600

H:1970mm CODE	WIDTH	*H:2150mm CODE	WIDTH
RVTISPOL30	300	RVTKPOL30	300
RVTISPOL30*	300	RVTETISPOL30*	300
RVTETISPOL30*	300		

Standard Mechanism inc.  
Kesseböhmer Mechanism inc.

## PULL-OUT LARDER

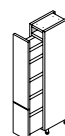

H:1970mm CODE	WIDTH	H:1970mm CODE	WIDTH
RVTLID30	300	RVTLID30	300
RVTLID40	400	RVTLID40	400
RVTLID50	500	RVTLID50	500
RVTLID60	600	RVTLID60	600

1x Standard, 4x Deep Drawers

## INNER DRAWER LARDER

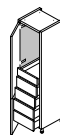
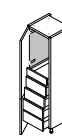

H:2150mm CODE	WIDTH	H:2150mm CODE	WIDTH
RVETLID30	300	RVETLID30	300
RVETLID40	400	RVETLID40	400
RVETLID50	500	RVETLID50	500
RVETLID60	600	RVETLID60	600

## DOUBLE OVEN

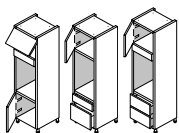

H:1970mm CODE	*H:2150mm WIDTH	H:1970mm CODE	*H:2150mm WIDTH
RVTOHD60	600	RVTOHS60	600
RVTOHDD60	600	RVTOHSD60	600
RVETOHDD60*	600	RVETOHS60*	600

## SINGLE OVEN

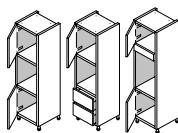

H:1970mm CODE	*H:2150mm WIDTH	H:1970mm CODE	*H:2150mm WIDTH
RVTOHD60	600	RVTOHS60	600
RVTOHDD60	600	RVTOHSD60	600
RVETOHDD60*	600	RVETOHS60*	600

## SINGLE OVEN + COMPACT

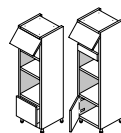

H:1970mm CODE	*H:2150mm WIDTH	H:1970mm CODE	*H:2150mm WIDTH
RVTOHSC60	600	RVTOHSC60	600
RVETOHSC60*	600		

## COMPACT

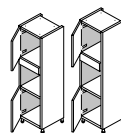

H:1970mm CODE	*H:2150mm WIDTH	H:1970mm CODE	*H:2150mm WIDTH
RVTOHC60	600	RVTOHC60	600
RVETOHC60*	600		

## FRIDGE + FRIDGE/FREEZER

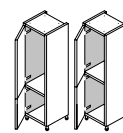

H:1970mm CODE	WIDTH	H:2150mm CODE	WIDTH
RVTF1F/60	600	RVTF1F/60	600
RVTF4F/60*	600	RVTF2F/60	600
RVTF1U/60*	600	RVTF3F/60*	600
RVTF4U/60*	600	RVTF1U/60*	600
		RVTF2U/60*	600
		RVTF3U/60**	600

\*For door on door appliances

\*For door on door appliances  
\*715mm bottom, 1425mm top door

END SUPPORT PANELS

CARCASE MFC PANELS

COMBI

PLINTH

PLANT ON END PANELS

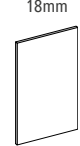
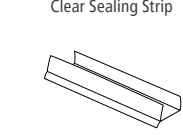
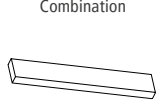
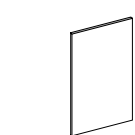
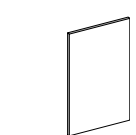

H:900mm

CODE	WIDTH
<b>ESP</b>	600
<b>900/700</b>	700

MFC Carcase

CODE	WXH
<b>1970/300</b>	300x1970
<b>2150/560</b>	560x2150
<b>2350/660</b>	660x2350
<b>720/300</b>	300x720
<b>900/2000</b>	2000x900
<b>900/300</b>	300x900

MFC Carcase

CODE	WXH
<b>UG/**ET</b>	1000x22
<b>UGET/MK</b>	1000x22

Un-Glued 1m Carcase Edging  
Un-Glued edging tape Per Mtr  
Door Finish

H:18mm

CODE	WXD
<b>CM/MK</b>	2700x70

Door Finish

H:150mm

CODE	WIDTH
<b>PL</b>	2940
<b>PL/MK</b>	2700

Melamine [Carcase MFC]  
Door Finish

Clear Sealing Strip

CODE	WIDTH
<b>PST</b>	3000

18mm

CODE	WXH
<b>2400/650/18MK</b>	650x2400
<b>940/375/18MK</b>	375x940
<b>900/650/18MK</b>	650x900

Door Finish

PLANT ON END PANELS

FURNITURE ACCESSORIES

INTEGRATED DOORS

SPARE DOOR FITTINGS

GENERAL ACCESSORIES

18mm Breakfast Bar Panel

Corner Post [Spare]

External Corner Post

Undrilled

Hinges  
[Hettich Soft Close]

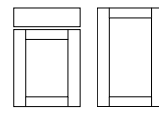

CODE

WXH
<b>900/1200/18MK</b>

1200x900  
Door Finish

H:684mm

CODE	WIDTH
<b>CPTH/MK</b>	146

Flat panel for on site conversion

H:684mm

CODE	WIDTH
<b>ECPTH/MK</b>	60

Two parts for on site conversion

CODE	WXH
<b>INT4568</b>	446x684
<b>INT4571</b>	446x715
<b>INT6045</b>	596x450

CODE	WXH
<b>INT6068</b>	596x684
<b>INT6071</b>	596x715

CODE

CODE	DESCRIPTION
<b>SCHINGE90</b>	90 degree [Pair]
<b>SCHINGE170</b>	170 degree [Pair]

CODE

CODE	DESCRIPTION
<b>STPWN</b>	Set of 2 Door strapping plates
<b>LEGSET</b>	Set of 4 Adjustable legs

Stays [Blum Aventos]  
**BLSTAYHKS**  
HK-S stay [Pair]  
\* [inc mounting brackets]

GOLA PROFILES - STANDARD

Base Units

Wall Units

Tall Units

CODE	LENGTH
<b>NGPTOP**</b>	4100
<b>NGPMID**</b>	4100

Top profile  
Mid profile  
**NGPFIXB**  
Fixing brackets [pack 10]  
**NGPTOPCAP\*\***  
Top profile end caps [Pr]  
**NGPMIDCAP\*\***  
Mid profile end caps [Pr]

CODE	DESCRIPTION
<b>NGPTOPEXT**</b>	Top profile external corner
<b>NGPTOPINT**</b>	Top profile internal corner
<b>NGPMIDEXT**</b>	Mid profile external corner
<b>NGPMIDINT**</b>	Mid profile internal corner
<b>NGPILCON</b>	In-line connector

CODE	LENGTH
<b>NGPWALL**</b>	3900

CODE	LENGTH
<b>NGPVS**</b>	2250
<b>NGPVD**</b>	2250
<b>NGPFIXVS</b>	Vertical SINGLE fixing [each] - 4 required per rail
<b>NGPFIXVD</b>	Vertical DOUBLE fixing [each] - 4 required per rail

CODE	DESCRIPTION
<b>NGPFIXVBKT</b>	Vertical rear fixing bracket [each] - 4 required per rail
<b>NGPAF580**</b>	Appliance filler 580mm



Standard colours  
- Matt Black [MB] and Anodised Steel [AS]

GOLA PROFILES - BESPOKE PAINTED - SOLID COLOURS

Base Units

Wall Units

Tall Units

CODE	LENGTH
<b>NGPTOP**</b>	3000
<b>NGPMID**</b>	3000

Top profile  
Mid profile  
**NGPFIX10**  
Fixing brackets [pack 10]  
**NGPTOPCAP\*\***  
Top profile end caps [Pr]  
**NGPMIDCAP\*\***  
Mid profile end caps [Pr]

CODE	DESCRIPTION
<b>NGPTOPEXT**</b>	Top profile external corner
<b>NGPTOPINT**</b>	Top profile internal corner
<b>NGPMIDEXT**</b>	Mid profile external corner
<b>NGPMIDINT**</b>	Mid profile internal corner
<b>NGPILCON</b>	In-line connector

CODE	LENGTH
<b>NGPWALL**</b>	3000

CODE	LENGTH
<b>NGPVS**</b>	2250
<b>NGPVD**</b>	2250
<b>NGPFIXVS</b>	Vertical SINGLE fixing [each] - 4 required per rail
<b>NGPFIXVD</b>	Vertical DOUBLE fixing [each] - 4 required per rail

CODE	DESCRIPTION
<b>NGPFIXVBKT</b>	Vertical rear fixing bracket [each] - 4 required per rail
<b>NGPAF580**</b>	Appliance filler 580mm



Bespoke solid colours  
- Dark Blue [DB], Grey Blue [GB], Graphite [GR], Leaf [LF], Light Grey [LG], Luna [LU], Peacock [PC] and Stone Blue [SB]

GOLA PROFILES - BESPOKE PAINTED - SHIMMERING COLOURS

Base Units

Wall Units

Tall Units

CODE	LENGTH
<b>NGPTOP**</b>	3000
<b>NGPMID**</b>	3000

Top profile  
Mid profile  
**NGPFIX10**  
Fixing brackets [pack 10]  
**NGPTOPCAP\*\***  
Top profile end caps [Pr]  
**NGPMIDCAP\*\***  
Mid profile end caps [Pr]

CODE	DESCRIPTION
<b>NGPTOPEXT**</b>	Top profile external corner
<b>NGPTOPINT**</b>	Top profile internal corner
<b>NGPMIDEXT**</b>	Mid profile external corner
<b>NGPMIDINT**</b>	Mid profile internal corner
<b>NGPILCON</b>	In-line connector

CODE	LENGTH
<b>NGPWALL**</b>	3000

CODE	LENGTH
<b>NGPVS**</b>	2250
<b>NGPVD**</b>	2250
<b>NGPFIXVS</b>	Vertical SINGLE fixing [each] - 4 required per rail
<b>NGPFIXVD</b>	Vertical DOUBLE fixing [each] - 4 required per rail

CODE	DESCRIPTION
<b>NGPFIXVBKT</b>	Vertical rear fixing bracket [each] - 4 required per rail
<b>NGPAF580**</b>	Appliance filler 580mm



Bespoke Shimmering Colours  
- Gold Dust [GD] and Rose Gold [RG]

- > When installing an integrated under counter appliance, please check the appliance height carefully to establish if it will fit below the top profile [812mm high or less]. The plinth height can be raised slightly to accommodate taller appliances.
  - > If using free-standing appliances, end panels must be fitted either side of the appliance and the rail profile finishes against the panel, and end caps fitted if required.
  - > A top rail profile cannot be used with a built-under single oven in the Verse range. The rails must stop on each side of the appliance and end caps fitted.
  - > When using a 'L' shaped corner wall unit, the Verse wall rail will need to be mitred on site.
  - > When planning ensure a 30mm gap is left between, or to the side of all Midi & Tall housings for the vertical profile to be fitted.
  - > When ordering Midi and Tall units, ensure that you specify either LHH [left hand hinge], RHH [right hand hinge] or Double [units with vertical profiles on both sides] to ensure that the unit ordered is supplied with the correct gables.
  - > When using either a sink or hob, the distance behind the top rail profile to the back of the carcass is 534mm, therefore units may need to be pulled forward from the wall to accommodate your products.
- See our Verse Technical Guide for further details on this range. Alternatively, you can call our Furniture team for product information.



Scan here to view our Verse Technical Guide.

Note: Furniture codes beginning with the letter 'R' are assembled (rigid), by removing the 'R' the units are supplied unassembled (flat-pack).



VERSE

PRICE GROUP 6+7

# LANGLEY

PAINT TO ORDER



Special sizes available

contact us for further information

Colours Options [PG6]: Auburn, Black, Bone, Cashmere, Coal, Cotton, Dusty Rose, Fern, Forest, Mink, Mist, Moss, Navy, Putty, Riptide, Sea Salt, Smoke, Space, Thyme and Twilight.

Bespoke Colour Option [PG7].



## HI-LINE BASE

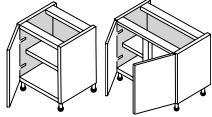

Pull-Out

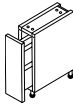

Shallow Base [300mm deep]

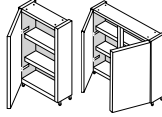

## HI-LINE CORNER BASE

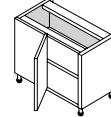

'L' Shaped

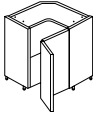

H:720mm CODE	WIDTH	CODE	WIDTH
RVBA15	150	RVBA70	700
RVBA30	300	RVBA80	800
RVBA35	350	RVBA90	900
RVBA40	400	RVBA10	1000
RVBA45	450	RVBA12	1200
RVBA50	500		
RVBA60	600		

H:720mm CODE	WIDTH	H:720mm CODE	WIDTH
RVBISPO15	150	RVBKPO15	150
Standard Mechanism inc.			
Kesseböhmer Mechanism inc.			
RVBKTP015 150			
Kesseböhmer Mechanism & Towel rail inc.			

H:720mm CODE	WIDTH	H:720mm CODE	WIDTH
RVSBU30	300	RVSBU70	700
RVSBU35	350	RVSBU80	800
RVSBU40	400	RVSBU90	900
RVSBU45	450	RVSBU10	1000
RVSBU50	500		
RVSBU60	600		

H:720mm CODE	WIDTH	CODE	WIDTH
RVBAC830	800/300	RVBAC950	900/500
RVBAC80	800/400	RVBAC960	900/600
RVBAC845	800/450	RVBAC140	1000/400
RVBAC850	800/500	RVBAC145	1000/450
RVBAC860	800/600	RVBAC100	1000/500
RVBAC940	900/400	RVBAC160	1000/600
RVBAC945	900/450	RVBAC120	1200/600

H:720mm CODE	WIDTH
VBAC90	900x900
Bi-fold hinge system Flatpack	

Inc. Corner Post & Blanking Panel

## BUILT UNDER OVEN

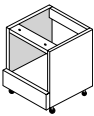

H:720mm CODE	WIDTH
RBUE060*	600

\*Non-verse spec.

## 2 DRAWER BASE

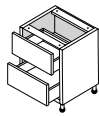

H:720mm CODE	WIDTH	H:720mm CODE	WIDTH
RVBD250	500	RVBD260	600
RVBD280	800	RVBD290	900
RVBD210	1000		
2x325mm Drawers			

## 3 DRAWER BASE

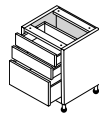

H:720mm CODE	WIDTH	H:720mm CODE	WIDTH
RVBD350	500	RVBD360	600
RVBD380	800	RVBD390	900
RVBD310	1000		
2x160mm, 1x325mm Drawers			

## LOW WALL

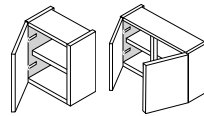

H:575mm CODE	WIDTH	H:575mm CODE	WIDTH
RVWU30-5	300	RVWU40-5	400
RVWU45-5	450	RVWU50-5	500
RVWU60-5	600		

## MEDIUM WALL

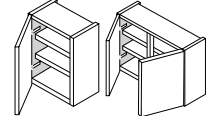

H:720mm CODE	WIDTH	H:720mm CODE	WIDTH
RVWU30-7	300	RVWU35-7	350
RVWU40-7	400	RVWU45-7	450
RVWU50-7	500	RVWU60-7	600

Add 'X' to the end of the code for 350mm deep

Add 'X' to the end of the code for 350mm deep

## MEDIUM WALL

'L' Shaped Corner

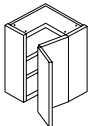

H:720mm CODE	D:300mm WIDTH
RVCW60-7	600x600

Add 'X' to the end of the code for 350mm deep [650x650]

Bi-Fold Hinge System

Bi-Fold

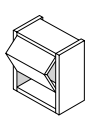

H:720mm CODE	D:300mm WIDTH	H:720mm CODE	D:300mm WIDTH
RVBFWU50-7	500	RVBFWU60-7	600
RVBFWU80-7	800	RVBFWU90-7	900
RVBFWU10-7	1000		

Mechanism inc.  
Add 'X' to the end of the code for 350mm deep

Glazed Door

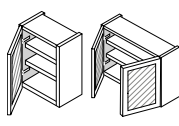

H:720mm CODE	D:300mm WIDTH	H:720mm CODE	D:300mm WIDTH
RVWGR50-7	500	RVWGR10-7	1000

Add 'X' to the end of the code for 350mm deep  
Reeded glass

## TALL WALL

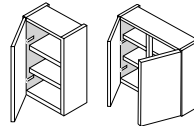

H:900mm CODE	WIDTH	H:900mm CODE	WIDTH
RVWU30-9	300	RVWU40-9	400
RVWU45-9	450	RVWU50-9	500
RVWU60-9	600		

Add 'X' to the end of the code for 350mm deep

Glazed Door

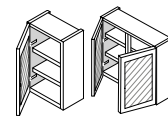

H:900mm CODE	D:300mm WIDTH	H:900mm CODE	D:300mm WIDTH
RVWGR50-9	500	RVWGR10-9	1000

Add 'X' to the end of the code for 350mm deep  
Reeded glass

Boiler

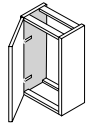

H:900mm CODE	WIDTH
VBWU6040-9	600

400mm deep  
Flatpack

## HORIZONTAL WALL

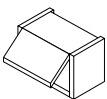

H:290mm CODE	D:300mm WIDTH	H:360mm CODE	D:300mm WIDTH
RVHWU5029	500	RVHWU5036	500
RVHWU6029	600	RVHWU6036	600
RVHWU8029	800	RVHWU8036	800
RVHWU9029	900	RVHWU9036	900
RVHWU1029	1000	RVHWU1036	1000

All include Blum Aventos HKS System  
Add 'X' to the end of the code for 350mm deep

## MIDI UNITS

RVRMLU60 RVMA160

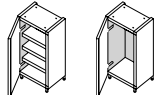

RVMD060 RVMOHS60

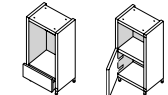

H:1250mm CODE	WIDTH
RVRMLU60	600
RVMA160	600
RVMD060	600
RVMOHS60	600

## LARDER

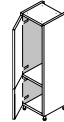

H:1970mm CODE	WIDTH
RVTLU30	300
RVTLU40	400
RVTLU50	500
RVTLU60	600

Single Door

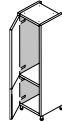

H:1970mm CODE	WIDTH
RVTLUSD50	500
RVTLUSD60	600

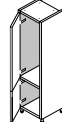

H:2150mm CODE	WIDTH
RVETLU30	300
RVETLU40	400
RVETLU50	500
RVETLU60	600

## PULL-OUT LARDER

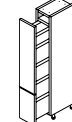

H:1970mm CODE	*H:2150mm WIDTH
RVTKPOL30	300
RVTKPOL30	300
RVTKPOL30*	300
RVTKPOL30*	300

Standard Mechanism inc.  
Kesseböhmer Mechanism inc.

## INNER DRAWER LARDER

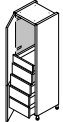

H:1970mm CODE	WIDTH
RVTLID30	300
RVTLID40	400
RVTLID50	500
RVTLID60	600

1 x Standard, 4 x Deep drawers

## INNER DRAWER LARDER

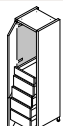

H:2150mm CODE	WIDTH
RVETLID30	300
RVETLID40	400
RVETLID50	500
RVETLID60	600

1 x Standard, 4 x Deep drawers

## DOUBLE OVEN

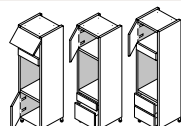

H:1970mm CODE	*H:2150mm WIDTH
RVTOHD60	600
RVTOHD60	600
RVETOHD60*	600

## SINGLE OVEN

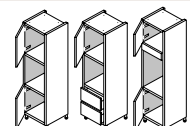

H:1970mm CODE	*H:2150mm WIDTH
RVTOHS60	600
RVTOHS60	600
RVETOHS60*	600

## SINGLE OVEN + COMPACT

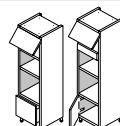

H:1970mm CODE	*H:2150mm WIDTH
RVTOHSC60	600
RVTOHSC60*	600

## COMPACT

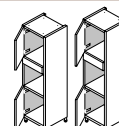

H:1970mm CODE	*H:2150mm WIDTH
RVTOHC60	600
RVTOHC60*	600

## FRIDGE + FRIDGE/FREEZER

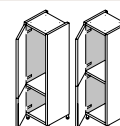

H:1970mm CODE	WIDTH	H:2150mm CODE	WIDTH
RVTF11/60	600	RVTF11/60	600
RVTF4/60*	600	RVTF2/60	600
		RVTF11/60*	600
		RVTF2/60*	600
		RVTF4/60*	600

\*Doors undrilled  
\*For door on door appliances

END SUPPORT PANELS

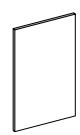

CODE	WIDTH
<b>ESP</b>	600
<b>900/700</b>	700

MFC Carcase

CARCASE MFC PANELS

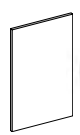

CODE	WXH
<b>1970/300</b>	300x1970
<b>2150/560</b>	560x2150
<b>2350/660</b>	660x2350
<b>720/300</b>	300x720
<b>900/2000</b>	2000x900
<b>900/300</b>	300x900
MFC Carcase	
<b>UG/**ET</b>	1000x22

Un-Glued 1m Carcase Edging

COMBI

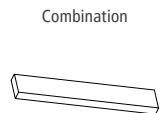

CODE	WIDTH
<b>PCM/B</b>	3000

Painted

CORNICE

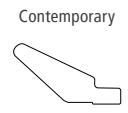

CODE	WIDTH
<b>COC/B</b>	3000

Painted

PLINTH

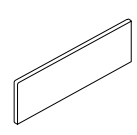

CODE	WIDTH
<b>PL</b>	2940

Melamine [Carcase MFC]  
**PL/B\*** 3000  
 Painted  
**VF/B** 3000  
 Veneered Filler Painted [inc. 2 long edges]  
 \*Includes PST sealing strip

PLANT ON END PANELS



CODE	WIDTH
<b>PST</b>	3000

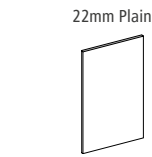

CODE	WXH
<b>2440/350/22B</b>	350x2440
<b>2440/650/22B</b>	650x2440
<b>900/650/22B</b>	650x900
<b>950/350/22B</b>	350x950
<b>900/1170/22B</b>	1170x900
<b>900/910/22B</b>	910x900

Painted

PLANT ON END PANELS

22mm Plain Breakfast Bar Back Panel

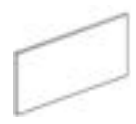

CODE	WXH
<b>900/2000/22B</b>	2000x900

Painted

50mm Mitred End Panel

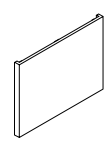

CODE	WXH
<b>MBEPA/B</b>	604x684
Base run	
<b>MIEP9A/B</b>	908x684
<b>MIEP12A/B</b>	1168x684

Island

FURNITURE ACCESSORIES

Corner Post [Spare]

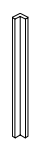

CODE	WIDTH
<b>CPH/B</b>	146

H:684mm

External Corner Post



CODE	WIDTH
<b>ECPTH/B</b>	48x48

H:684mm

INTEGRATED DOORS

Undrilled

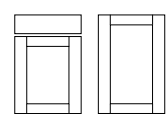

CODE	WXH
<b>INT4568</b>	446x684
<b>INT4571</b>	446x715
<b>INT6045</b>	596x450
<b>INT6068</b>	596x684
<b>INT6071</b>	596x715

SPARE DOOR FITTINGS

Hinges [Hettich Soft Close]

CODE	DESCRIPTION
<b>SCHINGE90</b>	90 degree [Pair]
<b>SCHINGE170</b>	170 degree [Pair]

Stays [Blum Aventos]

CODE	DESCRIPTION
<b>BLSTAYHKS</b>	HK-S stay [Pair]

\*[inc mounting brackets]

GENERAL ACCESSORIES

CODE	DESCRIPTION
<b>STPWN</b>	Set of 2 Door strapping plates
<b>LEGSET</b>	Set of 4 Adjustable legs
<b>PCC/B</b>	Painted care kit

GOLA PROFILES - STANDARD

Base Units

CODE	LENGTH
<b>NGPTOP**</b>	4100
Top profile	
<b>NGPMID**</b>	4100
Mid profile	
<b>NGPFIXB</b>	
Fixing brackets [pack 10]	
<b>NGPTOPCAP**</b>	
Top profile end caps [Pr]	
<b>NGPMIDCAP**</b>	
Mid profile end caps [Pr]	

Wall Units

CODE	LENGTH
<b>NGPWALL**</b>	3900

Tall Units

CODE	LENGTH
<b>NGPVS**</b>	2250
Vertical single profile	
<b>NGPVD**</b>	2250
Vertical double profile	
<b>NGPFIXVS</b>	
Vertical SINGLE fixing [each]	
- 4 required per rail	
<b>NGPFIXVD</b>	
Vertical DOUBLE fixing [each]	
- 4 required per rail	



Standard colours - Matt Black [MB] and Anodised Steel [AS]

GOLA PROFILES - BESPOKE PAINTED - SOLID COLOURS

Base Units

CODE	LENGTH
<b>NGPTOP**</b>	3000
Top profile	
<b>NGPMID**</b>	3000
Mid profile	
<b>NGPFIX10</b>	
Fixing brackets [pack 10]	
<b>NGPTOPCAP**</b>	
Top profile end caps [Pr]	
<b>NGPMIDCAP**</b>	
Mid profile end caps [Pr]	

Wall Units

CODE	LENGTH
<b>NGPWALL**</b>	3000

Tall Units

CODE	LENGTH
<b>NGPVS**</b>	2250
Vertical single profile	
<b>NGPVD**</b>	2250
Vertical double profile	
<b>NGPFIXVS</b>	
Vertical SINGLE fixing [each]	
- 4 required per rail	
<b>NGPFIXVD</b>	
Vertical DOUBLE fixing [each]	
- 4 required per rail	



Bespoke solid colours - Dark Blue [DB], Grey Blue [GB], Graphite [GR], Leaf [LF], Light Grey [LG], Luna [LU], Peacock [PC] and Stone Blue [SB]

GOLA PROFILES - BESPOKE PAINTED - SHIMMERING COLOURS

Base Units

CODE	LENGTH
<b>NGPTOP**</b>	3000
Top profile	
<b>NGPMID**</b>	3000
Mid profile	
<b>NGPFIX10</b>	
Fixing brackets [pack 10]	
<b>NGPTOPCAP**</b>	
Top profile end caps [Pr]	
<b>NGPMIDCAP**</b>	
Mid profile end caps [Pr]	

Wall Units

CODE	LENGTH
<b>NGPWALL**</b>	3000

Tall Units

CODE	LENGTH
<b>NGPVS**</b>	2250
Vertical single profile	
<b>NGPVD**</b>	2250
Vertical double profile	
<b>NGPFIXVS</b>	
Vertical SINGLE fixing [each]	
- 4 required per rail	
<b>NGPFIXVD</b>	
Vertical DOUBLE fixing [each]	
- 4 required per rail	



Bespoke Shimmering Colours - Gold Dust [GD] and Rose Gold [RG]

- > When installing an integrated under counter appliance, please check the appliance height carefully to establish if it will fit below the top profile [812mm high or less]. The plinth height can be raised slightly to accommodate taller appliances.
  - > If using free-standing appliances, end panels must be fitted either side of the appliance and the rail profile finishes against the panel, and end caps fitted if required.
  - > A top rail profile cannot be used with a built-under single oven in the Verse range. The rails must stop on each side of the appliance and end caps fitted.
  - > When using a 'L' shaped corner wall unit, the Verse wall rail will need to be mitred on site.
  - > When planning ensure a 30mm gap is left between, or to the side of all Midi & Tall housings for the vertical profile to be fitted.
  - > When ordering Midi and Tall units, ensure that you specify either LHH [left hand hinge], RHH [right hand hinge] or Double [units with vertical profiles on both sides] to ensure that the unit ordered is supplied with the correct gables.
  - > When using either a sink or hob, the distance behind the top rail profile to the back of the carcass is 534mm, therefore units may need to be pulled forward from the wall to accommodate your products.
- See our Verse Technical Guide for further details on this range. Alternatively, you can call our Furniture team for product information.



Scan here to view our Verse Technical Guide.

Note: Furniture codes beginning with the letter 'R' are assembled (rigid), by removing the 'R' the units are supplied unassembled (flat-pack).

VERSE

# PRICE GROUP 7 + 8

## SHOREDITCH

PAINT TO ORDER

Special sizes available  
contact us for further information

Colours Options [PG7]: Auburn, Black, Bone, Cashmere, Coal, Cotton, Dusty Rose, Fern, Forest, Mink, Mist, Moss, Navy, Putty, Riptide, Sea Salt, Smoke, Space, Thyme and Twilight.

Bespoke Colour Option [PG8].



### HI-LINE BASE

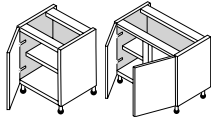

H:720mm CODE	WIDTH	CODE	WIDTH
RVBA15	150	RVBA70	700
RVBA30	300	RVBA80	800
RVBA35	350	RVBA90	900
RVBA40	400	RVBA10	1000
RVBA45	450	RVBA12	1200
RVBA50	500		
RVBA60	600		

### Pull-Out

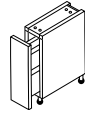

H:720mm CODE	WIDTH	CODE	WIDTH
RVBISPO15	150		
Standard Mechanism inc.			
RVBKPO15	150		
Kesseböhmer Mechanism inc.			
RVBKTP015	150		
Kesseböhmer Mechanism & Towel rail inc.			

### Shallow Base [300mm deep]

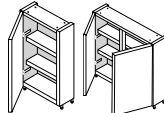

H:720mm CODE	WIDTH	CODE	WIDTH
RVBSU30	300	RVBSU70	700
RVBSU35	350	RVBSU80	800
RVBSU40	400	RVBSU90	900
RVBSU45	450	RVBSU10	1000
RVBSU50	500		
RVBSU60	600		

### HI-LINE CORNER BASE

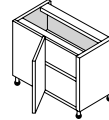

H:720mm CODE	WIDTH	CODE	WIDTH
RVBAC830	800/300	RVBAC950	900/500
RVBAC80	800/400	RVBAC960	900/600
RVBAC845	800/450	RVBAC140	1000/400
RVBAC850	800/500	RVBAC145	1000/450
RVBAC860	800/600	RVBAC10	1000/500
RVBAC940	900/400	RVBAC160	1000/600
RVBAC945	900/450	RVBAC12	1200/600

### 'L' Shaped

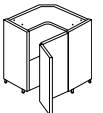

H:720mm CODE	WIDTH	CODE	WIDTH
VBAC90	900x900		

Bi-fold hinge system Flatpack  
Inc. Corner Post & Blanking Panel

### BUILT UNDER OVEN

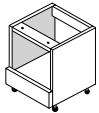

H:720mm CODE	WIDTH
RBUE06*	600

\*Non-verse spec.

### 2 DRAWER BASE

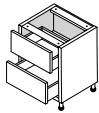

H:720mm CODE	WIDTH	CODE	WIDTH
RVBD250	500		
RVBD260	600		
RVBD280	800		
RVBD290	900		
RVBD210	1000		

2x325mm Drawers

### 3 DRAWER BASE

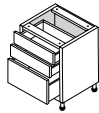

H:720mm CODE	WIDTH	CODE	WIDTH
RVBD350	500		
RVBD360	600		
RVBD380	800		
RVBD390	900		
RVBD310	1000		

2x160mm, 1x325mm Drawers

### LOW WALL

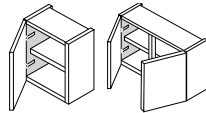

H:575mm CODE	WIDTH	CODE	WIDTH
RVWU30-5	300	RVWU80-5	800
RVWU40-5	400	RVWU90-5	900
RVWU45-5	450	RVWU10-5	1000
RVWU50-5	500		
RVWU60-5	600		

Add 'X' to the end of the code for 350mm deep

### MEDIUM WALL

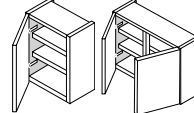

H:720mm CODE	WIDTH	CODE	WIDTH
RVWU30-7	300	RVWU70-7	700
RVWU35-7	350	RVWU80-7	800
RVWU40-7	400	RVWU90-7	900
RVWU45-7	450	RVWU10-7	1000
RVWU50-7	500		
RVWU60-7	600		

Add 'X' to the end of the code for 350mm deep

### 'L' Shaped Corner

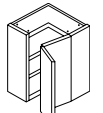

H:720mm CODE	WIDTH	CODE	WIDTH
RVCWL60-7	600x600		

Add 'X' to the end of the code for 350mm deep [650x650]

Bi-Fold Hinge System

### MEDIUM WALL

#### Bi-Fold

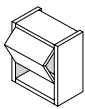

H:720mm CODE	D:300mm WIDTH	H:720mm CODE	D:300mm WIDTH
RVBFWU50-7	500	RVWG50-7	500
RVBFWU60-7	600	RVWG10-7	1000
RVBFWU80-7	800	RVWGR50-7*	500
RVBFWU90-7	900	RVWGR10-7*	1000
RVBFWU10-7	1000		

Add 'X' to the end of the code for 350mm deep

#### Glazed Door

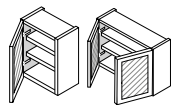

\*Reeded glass

#### Glazed Door - 1 Cross Rail

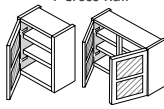

Add 'X' to the end of the code for 350mm deep

### TALL WALL

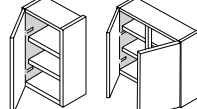

H:900mm CODE	WIDTH	CODE	D:300mm WIDTH
RVWU30-9	300	RVWU80-9	800
RVWU40-9	400	RVWU90-9	900
RVWU45-9	450	RVWU10-9	1000
RVWU50-9	500		
RVWU60-9	600		

Add 'X' to the end of the code for 350mm deep

#### Glazed Door

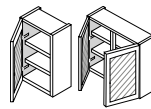

Add 'X' to the end of the code for 350mm deep

#### Glazed Door - 1 Cross Rail

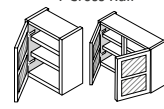

Add 'X' to the end of the code for 350mm deep

#### Boiler

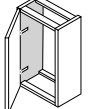

H:900mm CODE	D:400mm WIDTH	CODE	WIDTH
VBWU6040-9	600		

Flatpack

### HORIZONTAL WALL

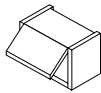

H:290mm CODE	D:300mm WIDTH	H:360mm CODE	D:300mm WIDTH
RVHWU5029	500	RVHWU5036	500
RVHWU6029	600	RVHWU6036	600
RVHWU8029	800	RVHWU8036	800
RVHWU9029	900	RVHWU9036	900
RVHWU1029	1000	RVHWU1036	1000

All include Blum Aventos HKS System  
Add 'X' to the end of the code for 350mm deep

### MIDI UNITS

#### RVRMLU60 RVMA160

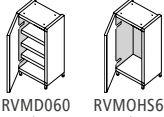

H:1250mm CODE	WIDTH	CODE	WIDTH
RVRMLU60	600		
RVMA160	600		
RVMD060	600		
RVMOH560	600		

### LARDER

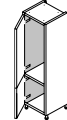

H:1970mm CODE	WIDTH	CODE	WIDTH
RVTLU30	300	RVCRTLU30	300
RVTLU40	400	RVCRTLU40	400
RVTLU50	500	RVCRTLU50	500
RVTLU60	600	RVCRTLU60	600

#### One Cross Rail - Upper Door

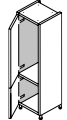

H:1970mm CODE	WIDTH	CODE	WIDTH
RVCRTLU30	300		
RVCRTLU40	400		
RVCRTLU50	500		
RVCRTLU60	600		

#### Single Door - Two Cross Rails

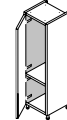

H:1970mm CODE	WIDTH	CODE	WIDTH
RVCRTLU30	300		
RVCRTLU40	400		
RVCRTLU50	500		
RVCRTLU60	600		

### PULL-OUT LARDER

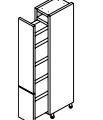

H:1970mm CODE	*H:2150mm WIDTH	CODE	WIDTH
RVITISPOL30	300		
RVTKPOL30	300		
RVETISPOL30*	300		
RVETKPOL30*	300		

Standard Mechanism inc. Kesseböhmer Mechanism inc.

### INNER DRAWER LARDER

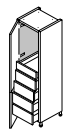

H:1970mm CODE	WIDTH	H:2150mm CODE	WIDTH
RVTLID30	300	RVETLID30	300
RVTLID40	400	RVETLID40	400
RVTLID50	500	RVETLID50	500
RVTLID60	600	RVETLID60	600

1 x Standard, 4 x Deep drawers

### DOUBLE OVEN

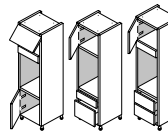

H:1970mm CODE	*H:2150mm WIDTH	CODE	WIDTH
RVTOHD60	600		
RVTOHDD60	600		
RVETOHDD60*	600		

### SINGLE OVEN

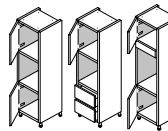

H:1970mm CODE	*H:2150mm WIDTH	CODE	WIDTH
RVTOHS60	600		
RVTOHSD60	600		
RVETOHSD60*	600		

### SINGLE OVEN + COMPACT

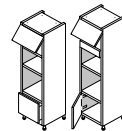

H:1970mm CODE	*H:2150mm WIDTH	CODE	WIDTH
RVTOHSC60	600		
RVETOHSC60*	600		

### COMPACT

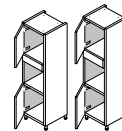

H:1970mm CODE	*H:2150mm WIDTH	CODE	WIDTH
RVTOHC60	600		
RVETOHC60*	600		

### FRIDGE + FRIDGE/FREEZER

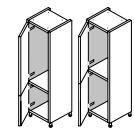

H:1970mm CODE	WIDTH	CODE	WIDTH
RVTF1/60	600	RVETF1/60	600
RVTF2/60	600	RVETF2/60	600
RVTF3/60	600	RVETF3/60	600
RVTF1U/60	600	RVETF1U/60	600
RVTF2U/60	600	RVETF2U/60	600
RVTF3U/60	600	RVETF3U/60	600

\*Doors undrilled  
\*For door on door appliances

H:2150mm CODE	WIDTH	CODE	WIDTH
RVETFF1/60	600		
RVETFF2/60	600		
RVETFF3/60	600		
RVETFF1U/60	600		
RVETFF2U/60	600		
RVETFF3U/60	600		

\*For door on door appliances  
\*715mm bottom, 1425mm top door



END SUPPORT PANELS



H:900mm	CODE	WIDTH
ESP	600	
900/700	700	

CARCASE MFC PANELS



CODE	WXH
1970/300	300x1970
2150/560	560x2150
2350/660	660x2350
720/300	300x720
900/2000	2000x900
900/300	300x900
MFC Carcase	
UG/**ET	1000x22
Un-Glued 1m Carcase Edging	

COMBI

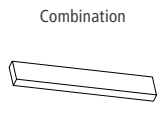

H:28mm	CODE	WIDTH
PCM/B	3000	

Painted

PLINTH

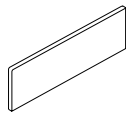

H:150mm	CODE	WIDTH
PL	2940	

Melamine [Carcase MFC]  
 PL/B\* 3000  
 Painted  
 VF/B 3000  
 Veneered Filler Painted [inc. 2 long edges]  
 \*Includes PST sealing strip



CODE	WIDTH
PST	3000

PLANT ON END PANELS

18mm Tongue & Grooved Reversible



CODE	WXH
2440/390T/B	390x2440
2440/650T/B	650x2440
950/390T/B	390x950
885/650T/B	650x885

T&G face has the superior finish  
 Painted  
 NOT Bone, Cotton, Fern, Putty, Riptide, Space & Twilight

18mm Plain Reversible

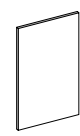

CODE	WXH
2440/390P/B	390x2440
2440/650P/B	650x2440
950/390P/B	390x950
885/650P/B	650x885

Plain face has the superior finish  
 Painted  
 NOT Bone, Cotton, Fern, Putty, Riptide, Space & Twilight

PLANT ON END PANELS

18mm Tongue & Grooved Plain Reversible

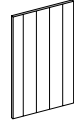

CODE	WXH
2440/390/B	390x2440
2440/650/B	650x2440
950/390/B	390x950
885/650/B	650x885

Painted  
 ONLY Bone, Cotton, Fern, Putty, Riptide, Space & Twilight

18mm Tongue & Grooved / Plain Reversible Breakfast Bar Panel



CODE	WXH
900/2000T/B	2000x900
900/2000P/B	2000x900
900/2000/B	2000x900

T&G face has the superior finish  
 Plain face has the superior finish  
 NOT Bone, Cotton, Fern, Putty, Riptide, Space & Twilight  
 ONLY Bone, Cotton, Fern, Putty, Riptide, Space & Twilight

Framed End Panel

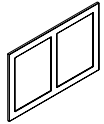

CODE	WXH
FEPTH9/B	800x684
FEPTH12/B	1060x684

Painted

FURNITURE ACCESSORIES

Corner Post [Spare]

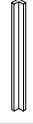

H:684mm	CODE	WIDTH
CPTH/B	146	

External Corner Post



H:684mm	CODE	WIDTH
ECPH/B	48x48	

INTEGRATED DOORS

Undrilled

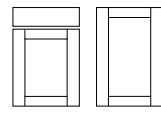

CODE	WXH
INT4568	446x684
INT4571	446x715
INT6045	596x450
INT6068	596x684
INT6071	596x715

SPARE DOOR FITTINGS

Hinges [Hettich Soft Close]

CODE
SCHINGE90
SCHINGE170

90 degree [Pair]  
 170 degree [Pair]

CODE	Set of
STPWN	2
LEGSET	4
PCC/B	

Door strapping plates  
 Adjustable legs  
 Painted care kit

Stays [Blum Aventos]

CODE
BLSTAYHKS

HK-S stay [Pair]  
 \* [inc mounting brackets]

GOLA PROFILES - STANDARD

Base Units

CODE	LENGTH
NGPTOP**	4100
NGPMID**	4100
NGPFIXB	
NGPTOPCAP**	
NGPMIDCAP**	

Top profile  
 Mid profile  
 Fixing brackets [pack 10]  
 Top profile end caps [Pr]  
 Mid profile end caps [Pr]

Wall Units

CODE	LENGTH
NGPWALL**	3900

Tall Units

CODE	LENGTH
NGPVS**	2250
NGPVD**	2250
NGPFIXVS	
NGPFIXVD	

Vertical single profile  
 Vertical double profile  
 Vertical SINGLE fixing [each]  
 Vertical DOUBLE fixing [each]



Standard colours - Matt Black [MB] and Anodised Steel [AS]

GOLA PROFILES - BESPOKE PAINTED - SOLID COLOURS

Base Units

CODE	LENGTH
NGPTOP**	3000
NGPMID**	3000
NGPFIX10	
NGPTOPCAP**	
NGPMIDCAP**	

Top profile  
 Mid profile  
 Fixing brackets [pack 10]  
 Top profile end caps [Pr]  
 Mid profile end caps [Pr]

Wall Units

CODE	LENGTH
NGPWALL**	3000

Tall Units

CODE	LENGTH
NGPVS**	2250
NGPVD**	2250
NGPFIXVS	
NGPFIXVD	

Vertical single profile  
 Vertical double profile  
 Vertical SINGLE fixing [each]  
 Vertical DOUBLE fixing [each]



Bespoke solid colours - Dark Blue [DB], Grey Blue [GB], Graphite [GR], Leaf [LF], Light Grey [LG], Luna [LU], Peacock [PC] and Stone Blue [SB]

GOLA PROFILES - BESPOKE PAINTED - SHIMMERING COLOURS

Base Units

CODE	LENGTH
NGPTOP**	3000
NGPMID**	3000
NGPFIX10	
NGPTOPCAP**	
NGPMIDCAP**	

Top profile  
 Mid profile  
 Fixing brackets [pack 10]  
 Top profile end caps [Pr]  
 Mid profile end caps [Pr]

Wall Units

CODE	LENGTH
NGPWALL**	3000

Tall Units

CODE	LENGTH
NGPVS**	2250
NGPVD**	2250
NGPFIXVS	
NGPFIXVD	

Vertical single profile  
 Vertical double profile  
 Vertical SINGLE fixing [each]  
 Vertical DOUBLE fixing [each]



Bespoke Shimmering Colours - Gold Dust [GD] and Rose Gold [RG]

- > When installing an integrated under counter appliance, please check the appliance height carefully to establish if it will fit below the top profile [812mm high or less]. The plinth height can be raised slightly to accommodate taller appliances.
  - > If using free-standing appliances, end panels must be fitted either side of the appliance and the rail profile finishes against the panel, and end caps fitted if required.
  - > A top rail profile cannot be used with a built-under single oven in the Verse range. The rails must stop on each side of the appliance and end caps fitted.
  - > When using a 'L' shaped corner wall unit, the Verse wall rail will need to be mitred on site.
  - > When planning ensure a 30mm gap is left between, or to the side of all Midi & Tall housings for the vertical profile to be fitted.
  - > When ordering Midi and Tall units, ensure that you specify either LHH [left hand hinge], RHH [right hand hinge] or Double [units with vertical profiles on both sides] to ensure that the unit ordered is supplied with the correct gables.
  - > When using either a sink or hob, the distance behind the top rail profile to the back of the carcass is 534mm, therefore units may need to be pulled forward from the wall to accommodate your products.
- See our Verse Technical Guide for further details on this range. Alternatively, you can call our Furniture team for product information.



Scan here to view our Verse Technical Guide.

Note: Furniture codes beginning with the letter 'R' are assembled (rigid), by removing the 'R' the units are supplied unassembled (flat-pack).



VERSE  
PRICE GROUP 3  
**ZETA**  
GLOSS + MATT

Special sizes available  
contact us for further information

Gloss Colours Options [PG3]: Cashmere, Grey and White  
Matt Colours Options [PG3]: Aegean, Blue Marble,  
Cashmere, Dust Grey, Graphite, Grey, Rose Marble and White.



HI-LINE BASE HI-LINE CORNER BASE 'L' Shaped

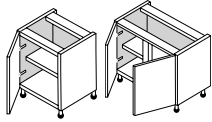

Pull-Out

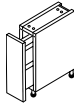

Shallow Base [300mm deep]

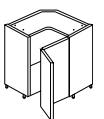
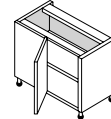
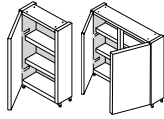

H:720mm CODE	WIDTH	CODE	WIDTH	H:720mm CODE	WIDTH	H:720mm CODE	WIDTH	CODE	WIDTH	H:720mm CODE	WIDTH	CODE	WIDTH	H:720mm CODE	WIDTH
RVBA15	150	RVBA60	600	RVBISPO15	150	RVBSBU30	300	RVBSBU70	700	RVBAC830	800/300	RVBAC950	900/500	VBAC90	900x900
RVBA26	260	RVBA70	700	Standard Mechanism inc.		RVBSBU35	350	RVBSBU80	800	RVBAC80	800/400	RVBAC960	900/600	Bi-fold hinge system	
RVBA30	300	RVBA80	800	RVBKP015	150	RVBSBU40	400	RVBSBU90	900	RVBAC845	800/450	RVBAC140	1000/400	Flatpack	
RVBA35	350	RVBA90	900	Kesseböhmer Mechanism inc.		RVBSBU45	450	RVBSBU10	1000	RVBAC850	800/500	RVBAC145	1000/450		
RVBA40	400	RVBA10	1000	RVBKTP015	150	RVBSBU50	500			RVBAC860	800/600	RVBAC100	1000/500		
RVBA45	450	RVBA12	1200	Kesseböhmer Mechanism & Towel rail inc.		RVBSBU60	600			RVBAC940	900/400	RVBAC160	1000/600		
RVBA50	500									RVBAC945	900/450	RVBAC12	1200/600		

Incl. Corner Post & Blanking Panel

BUILT UNDER OVEN 2 DRAWER BASE 3 DRAWER BASE LOW WALL MEDIUM WALL

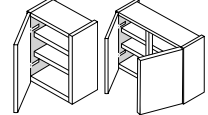
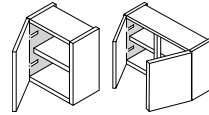
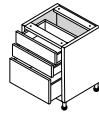
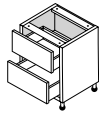
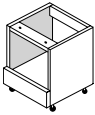

H:720mm CODE	WIDTH	H:720mm CODE	WIDTH	H:720mm CODE	WIDTH	H:575mm CODE	WIDTH	CODE	WIDTH	H:720mm CODE	WIDTH	CODE	WIDTH	D:300mm CODE	WIDTH
RBUE06*	600	RVBD230	300	RVBD330	300	RVWU30-5	300	RVWU80-5	800	RVWU26-7	260	RVWU60-7	600		
*Non-verse spec.		RVBD240	400	RVBD340	400	RVWU40-5	400	RVWU90-5	900	RVWU30-7	300	RVWU70-7	700		
		RVBD250	500	RVBD350	500	RVWU45-5	450	RVWU10-5	1000	RVWU35-7	350	RVWU80-7	800		
		RVBD260	600	RVBD360	600	RVWU50-5	500			RVWU40-7	400	RVWU90-7	900		
		RVBD280	800	RVBD380	800	RVWU60-5	600			RVWU45-7	450	RVWU10-7	1000		
		RVBD290	900	RVBD390	900					RVWU50-7	500				
		RVBD210	1000	RVBD310	1000										

MEDIUM WALL TALL WALL HORIZONTAL WALL

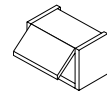
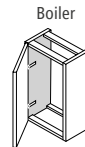
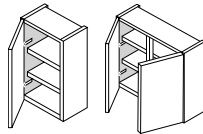
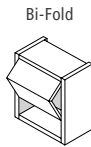
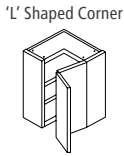

H:720mm CODE	D:300mm WIDTH	H:720mm CODE	D:300mm WIDTH	H:900mm CODE	WIDTH	D:300mm CODE	WIDTH	H:900mm CODE	WIDTH	H:290mm CODE	D:300mm WIDTH	H:360mm CODE	D:300mm WIDTH
RVCWL60-7	600x600	RVBFWU50-7	500	RVWU30-9	300	RVWU80-9	800	VBWU6040-9	600	RVHWU5029	500	RVHWU5036	500
Add 'X' to the end of the code for 350mm deep [650x650]		RVBFWU60-7	600	RVWU40-9	400	RVWU90-9	900	400mm deep Flatpack		RVHWU6029	600	RVHWU6036	600
Bi-Fold Hinge System		RVBFWU80-7	800	RVWU45-9	450	RVWU10-9	1000			RVHWU8029	800	RVHWU8036	800
		RVBFWU90-7	900	RVWU50-9	500					RVHWU9029	900	RVHWU9036	900
		RVBFWU10-7	1000	RVWU60-9	600					RVHWU1029	1000	RVHWU1036	1000

Mechanism inc.  
Add 'X' to the end of the code for 350mm deep

Add 'X' to the end of the code for 350mm deep

All include Blum Aventos HKS System  
Add 'X' to the end of the code for 350mm deep

MIDI UNITS LARDER PULL-OUT LARDER INNER DRAWER LARDER

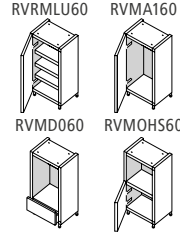

H:1250mm CODE	WIDTH
RVRLMU60	600
RVMA160	600
RVMD060	600
RVMOHS60	600

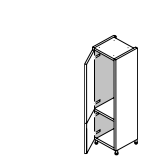

H:1970mm CODE	WIDTH
RVTLU30	300
RVTLU40	400
RVTLU50	500
RVTLU60	600

Single Door

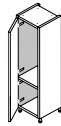

H:1970mm CODE	WIDTH
RVTLUSD50	500
RVTLUSD60	600

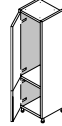

H:2150mm CODE	WIDTH
RVETLU30	300
RVETLU40	400
RVETLU50	500
RVETLU60	600

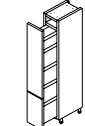

H:1970mm CODE	*H:2150mm WIDTH
RVTKPOL30	300
RVTKPOL30	300
RVETISPOL30*	300
RVETKPOL30*	300

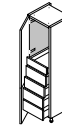

H:1970mm CODE	WIDTH
RVTLID30	300
RVTLID40	400
RVTLID50	500
RVTLID60	600

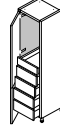

H:2150mm CODE	WIDTH
RVETLID30	300
RVETLID40	400
RVETLID50	500
RVETLID60	600

1x Standard, 4x Deep Drawers

DOUBLE OVEN SINGLE OVEN SINGLE OVEN + COMPACT COMPACT FRIDGE + FRIDGE/FREEZER

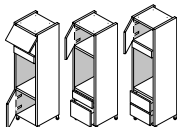

H:1970mm CODE	*H:2150mm WIDTH
RVTOHD60	600
RVTOHDD60	600
RVTOHDD60*	600

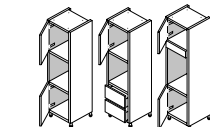

H:1970mm CODE	*H:2150mm WIDTH
RVTOHS60	600
RVTOHSD60	600
RVTOHS60*	600

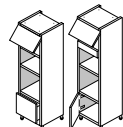

H:1970mm CODE	*H:2150mm WIDTH
RVTOHSC60	600
RVTOHSC60*	600

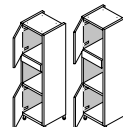

H:1970mm CODE	*H:2150mm WIDTH
RVTOHC60	600
RVETOHC60*	600

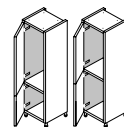

H:1970mm CODE	WIDTH
RVTF160	600
RVTF460*	600
*Doors undrilled	
RVTF1U/60*	600
RVTF4U/60*	600
*For door on door appliances	

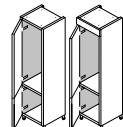

H:2150mm CODE	WIDTH
RVETFF160	600
RVETFF260	600
RVETFF1U/60*	600
RVETFF2U/60*	600
*For door on door appliances	

END SUPPORT PANELS

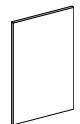

CODE	WIDTH
<b>ESP</b>	600
<b>900/700</b>	700

MFC Carcase

CARCASE MFC PANELS

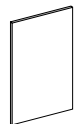

CODE	WXH
<b>1970/300</b>	300x1970
<b>2150/560</b>	560x2150
<b>2350/660</b>	660x2350
<b>720/300</b>	300x720
<b>900/2000</b>	2000x900
<b>900/300</b>	300x900

MFC Carcase

COMBI



CODE	WXH
<b>UG/**ET</b>	1000x22
<b>10ET/P*</b>	Un-glued Edging Tape 10mtr

Un-glued 1m Carcase Edging  
Un-glued Edging Tape 10mtr  
Door Finish  
\*M = Matt / G = Gloss

COMBI

Universal Pelmet/Pilaster

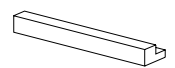

CODE	WXD
<b>UPCM/P*</b>	2740x55

H:36mm  
Door finish  
Can also be used as a 36mm wide end post - rebated for plant-on end panels  
\*M = Matt / G = Gloss

PLINTH

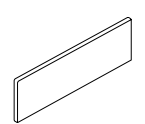

CODE	WIDTH
<b>PL</b>	2940
<b>PL/P*</b>	2740

H:150mm  
Melamine [Carcase MFC]  
Door Finish  
\*M = Matt / G = Gloss

PLANT ON END PANELS

Clear Sealing Strip

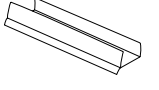

CODE	WIDTH
<b>PST</b>	3000

H:150mm

PLANT ON END PANELS

18mm

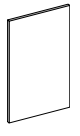

CODE	WXH
<b>2400/650/18P*</b>	650x2400
<b>900/350/18P*</b>	350x900
<b>900/650/18P*</b>	650x900

Door Finish  
\*M = Matt / G = Gloss

PLANT ON END PANELS

18mm Breakfast Bar Panel

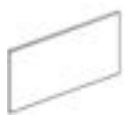

CODE	WXH
<b>900/1200/18P*</b>	1200x900
<b>900/2400/18P*</b>	2400x900

Door Finish  
\*M = Matt / G = Gloss

FURNITURE ACCESSORIES

46mm Mitred End Panel

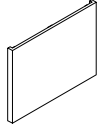

CODE	WXH
<b>MIEP9B/P*</b>	900x325
<b>MIEP9A/P*</b>	900x684
<b>MIEP12B/P*</b>	1160x325
<b>MIEP12A/P*</b>	1160x684

Door Finish  
\*M = Matt / G = Gloss

FURNITURE ACCESSORIES

Corner Post [Spare]

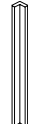

CODE	WIDTH
<b>CPTH/P*</b>	146

H:684mm  
Flat panel for on site conversion  
\*M = Matt / G = Gloss

INTEGRATED DOORS

Undrilled

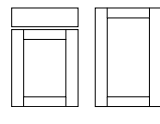

CODE	WXH
<b>INT4568</b>	446x684
<b>INT4571</b>	446x715
<b>INT6045</b>	596x450

Door Finish

SPARE DOOR FITTINGS

Hinges

[Hettich Soft Close]

CODE	DESCRIPTION
<b>SCHINGE90</b>	90 degree [Pair]
<b>SCHINGE170</b>	170 degree [Pair]

Stays [Blum Aventos]

CODE	DESCRIPTION
<b>BLSTAYHKS</b>	HK-S stay [Pair]

\*[inc mounting brackets]

GENERAL ACCESSORIES

CODE	DESCRIPTION
<b>STPWN</b>	Set of 2 Door strapping plates
<b>LEGSET</b>	Set of 4 Adjustable legs

GOLA PROFILES - STANDARD

Base Units

CODE	LENGTH
<b>NGPTOP**</b>	4100
<b>NGPMID**</b>	4100

Wall Units

CODE	LENGTH
<b>NGPTOPEXT**</b>	Top profile external corner
<b>NGPTOPINT**</b>	Top profile internal corner
<b>NGPMIDEXT**</b>	Mid profile external corner
<b>NGPMIDINT**</b>	Mid profile internal corner
<b>NGPILCON</b>	In-line connector

Wall Units

CODE	LENGTH
<b>NGPWALL**</b>	3900

Tall Units

CODE	LENGTH
<b>NGPVS**</b>	2250
<b>NGPVD**</b>	2250
<b>NGPFIXVS</b>	Vertical SINGLE fixing [each]
<b>NGPFIXVD</b>	Vertical DOUBLE fixing [each]

CODE	DESCRIPTION
<b>NGPFIXVBKT</b>	Vertical rear fixing bracket [each]
<b>NGPAF580**</b>	Appliance filler 580mm



Standard colours - Matt Black [MB] and Anodised Steel [AS]

GOLA PROFILES - BESPOKE PAINTED - SOLID COLOURS

Base Units

CODE	LENGTH
<b>NGPTOP**</b>	3000
<b>NGPMID**</b>	3000

Wall Units

CODE	LENGTH
<b>NGPTOPEXT**</b>	Top profile external corner
<b>NGPTOPINT**</b>	Top profile internal corner
<b>NGPMIDEXT**</b>	Mid profile external corner
<b>NGPMIDINT**</b>	Mid profile internal corner
<b>NGPILCON</b>	In-line connector

Wall Units

CODE	LENGTH
<b>NGPWALL**</b>	3000

Tall Units

CODE	LENGTH
<b>NGPVS**</b>	2250
<b>NGPVD**</b>	2250
<b>NGPFIXVS</b>	Vertical SINGLE fixing [each]
<b>NGPFIXVD</b>	Vertical DOUBLE fixing [each]

CODE	DESCRIPTION
<b>NGPFIXVBKT</b>	Vertical rear fixing bracket [each]
<b>NGPAF580**</b>	Appliance filler 580mm



Bespoke solid colours - Dark Blue [DB], Grey Blue [GB], Graphite [GR], Leaf [LF], Light Grey [LG], Luna [LU], Peacock [PC] and Stone Blue [SB]

GOLA PROFILES - BESPOKE PAINTED - SHIMMERING COLOURS

Base Units

CODE	LENGTH
<b>NGPTOP**</b>	3000
<b>NGPMID**</b>	3000

Wall Units

CODE	LENGTH
<b>NGPTOPEXT**</b>	Top profile external corner
<b>NGPTOPINT**</b>	Top profile internal corner
<b>NGPMIDEXT**</b>	Mid profile external corner
<b>NGPMIDINT**</b>	Mid profile internal corner
<b>NGPILCON</b>	In-line connector

Wall Units

CODE	LENGTH
<b>NGPWALL**</b>	3000

Tall Units

CODE	LENGTH
<b>NGPVS**</b>	2250
<b>NGPVD**</b>	2250
<b>NGPFIXVS</b>	Vertical SINGLE fixing [each]
<b>NGPFIXVD</b>	Vertical DOUBLE fixing [each]

CODE	DESCRIPTION
<b>NGPFIXVBKT</b>	Vertical rear fixing bracket [each]
<b>NGPAF580**</b>	Appliance filler 580mm



Bespoke Shimmering Colours - Gold Dust [GD] and Rose Gold [RG]

- > When installing an integrated under counter appliance, please check the appliance height carefully to establish if it will fit below the top profile [812mm high or less]. The plinth height can be raised slightly to accommodate taller appliances.
  - > If using free-standing appliances, end panels must be fitted either side of the appliance and the rail profile finishes against the panel, and end caps fitted if required.
  - > A top rail profile cannot be used with a built-under single oven in the Verse range. The rails must stop on each side of the appliance and end caps fitted.
  - > When using a 'L' shaped corner wall unit, the Verse wall rail will need to be mitred on site.
  - > When planning ensure a 30mm gap is left between, or to the side of all Midi & Tall housings for the vertical profile to be fitted.
  - > When ordering Midi and Tall units, ensure that you specify either LHH [left hand hinge], RHH [right hand hinge] or Double [units with vertical profiles on both sides] to ensure that the unit ordered is supplied with the correct gables.
  - > When using either a sink or hob, the distance behind the top rail profile to the back of the carcass is 534mm, therefore units may need to be pulled forward from the wall to accommodate your products.
- See our Verse Technical Guide for further details on this range. Alternatively, you can call our Furniture team for product information.



Scan here to view our Verse Technical Guide.





# Shaker.

If your style is traditionally English, contemporary country, or naturally rustic, have a look at the kitchens in our Shaker collection.

Caple's shaker kitchens are characterised by elegant details, rich woods, and subtle colours, put together with our high standards of build and attention to detail.





SHAKER  
PRICE GROUP 5 + 6  
**CHESTER**  
PAINT TO ORDER

Special sizes available [Not Oak]  
contact us for further information

Chester Sanded [PG5]  
Oak [PG6]

PTO Colours Options [PG6]: Alabaster, Antique Red, Black, Blush,  
Charcoal, Dark Sage, Dust Grey, Federal Blue, Fern, Gummetal,  
Heritage Green, Hunter, Indigo, Ink, Light Grey, Midnight Blue, Mussel,  
Palladian Blue, Pebble, Porcelain, Sage, Stone Grey, Storm and Woodland Grey.



HI-LINE BASE LOW BASE HI-LINE CORNER BASE

Pull-Out				Curved Door		Curved Return		Splayed		Shallow Base [300mm deep]		LOW BASE		HI-LINE CORNER BASE	
H:720mm CODE	WIDTH	CODE	WIDTH	H:720mm CODE	WIDTH	H:720mm CODE	WIDTH	H:720mm CODE	WIDTH	H:720mm CODE	WIDTH	H:720mm CODE	WIDTH	H:720mm CODE	WIDTH
RBA15	150	R2BA60*	600	RBISPO15	150	RCDBA30	300x300	RCRBA26	260x300	RABA360	360	RSBU30	300	RLBU30	300
RBA26	260	RBA70#	700	Standard Mechanism inc.						RSBU35	350	RLBU40	400	BAC90 900x900	
RBA30	300	RBA80#	800	RBKPO15 150						RSBU40	400	RLBU45	450	Bi-fold hinge system	
RBA35	350	RBA90#	900	Kesseböhmer Mechanism inc.						RSBU45	450	RLBU50	500	Flat pack	
RBA40	400	RBA10#	1000	RBKTP015 150						RSBU50	500	RLBU60	600		
RBA45	450	RBA12#	1200	Kesseböhmer Mechanism & Towel rail inc.						RSBU60	600	RLBU80#	800		
RBA50	500	*No muntin [2x300 doors]								RSBU70#	700	RLBU90#	900		
RBA60	600	# 2 x Doors								RSBU80#	800	RLBU10#	1000		
										RSBU90#	900	RLBU12#	1200		
										RSBU10#	1000	# 2 x Doors			

HI-LINE CORNER BASE DRAWERLINE BASE DRAWERLINE SINK BASE CERAMIC SINK BASE DRAWERLINE CORNER BASE

Diagonal				Single Top Drawer				DRAWERLINE SINK BASE				CERAMIC SINK BASE		DRAWERLINE CORNER BASE			
H:720mm CODE	WIDTH	H:720mm CODE	WIDTH	H:720mm CODE	WIDTH	H:720mm CODE	WIDTH	H:720mm CODE	WIDTH	H:720mm CODE	WXH	H:720mm CODE	WIDTH	H:720mm CODE	WIDTH	H:720mm CODE	WIDTH
CDA90	900x900	RBAC830	800/300	RBAC950	900/500	RBD30	300	RBD80/1	800	RBD50	500	RBSU60	600x460	RBDC830	800/300	RBDC140	1000/400
Flat pack		RBAC80	800/400	RBAC960	900/600	RBD40	400	RBD90/1	900	RBD60	600	To suit a sink height of 260mm		RBDC80	800/400	RBDC145	1000/450
		RBAC845	800/450	RBAC140	1000/400	RBD45	450	RBD10/1	1000	RBD80#	800	To suit a sink height of 220mm		RBSU8050	800x500	RBDC845	800/450
		RBAC850	800/500	RBAC145	1000/450	RBD50	500			RBD90#	900			RBDC850	800/500	RBDC160	1000/600
		RBAC860	800/600	RBAC10	1000/500	RBD60	600			RBD10*	1000			RBDC860	800/600	RBDC12	1200/600
		RBAC940	900/400	RBAC160	1000/600	RBD80#	800			RBD12*	1200			Inc. Corner Post & Blanking Panel			
		RBAC945	900/450	RBAC12	1200/600	RBD90#	900			*One working drawer # 2 x Doors							
						RBD10#	1000										
						RBD12#	1200										
						# 2 x Doors											

BUILT UNDER 2 DRAWER BASE 3 DRAWER BASE 4 DRAWER BASE 5 DRAWER BASE LOW WALL

Oven		2 DRAWER BASE		3 DRAWER BASE		4 DRAWER BASE		5 DRAWER BASE		LOW WALL		Diagonal Corner		Splayed	
H:720mm CODE	WIDTH	H:720mm CODE	WIDTH	H:720mm CODE	WIDTH	H:720mm CODE	WIDTH	H:720mm CODE	WIDTH	H:575mm CODE	WIDTH	H:575mm CODE	D:300mm WIDTH	H:575mm CODE	D:300mm WIDTH
RBWU60	600	RBD250	500	RBD350	500	RBD450	500	RBD530	300	RWU30-5	300	R2WU60-5*	600	RCWD60-5	600x600
		RBD260	600	RBD360	600	RBD460	600	RBD540	400	RWU40-5	400	RWU80-5#	800	Add 'X' to the end of the code for 350mm deep [650x650]	
		RBD280	800	RBD380	800	RBD480	800	RBD545	450	RWU45-5	450	RWU90-5#	900	Add 'X' to the end of the code for 350mm deep	
		RBD290	900	RBD390	900	RBD490	900	RBD550	500	RWU50-5	500	RWU10-5#	1000	*No muntin [2 x 300 doors] # 2 x Doors	
		RBD210	1000	RBD310	1000	RBD410	1000	RBD560	600	RWU60-5	600	Add 'X' to the end of the code for 350mm deep			
		2x355mm Drawers		1x140mm, 2x283mm Drawers		3x140mm, 1x283mm drawers		RBD580 800							
				RBD350/175 500		RBD450/175 500		RBD590 900							
				RBD360/175 600		RBD460/175 600		RBD510 1000							
				2 x 175mm, 1x355mm Drawers		4x175mm Drawers		5x140mm Drawers							

MEDIUM WALL

Bi-Fold		Glazed Door		Diagonal Corner		'L' Shaped Corner		Conventional Corner		Splayed		Curved Door		Microwave Wall	
H:720mm CODE	WIDTH	D:300mm CODE	WIDTH	H:720mm CODE	D:300mm WIDTH	H:720mm CODE	D:300mm WIDTH	H:720mm CODE	D:300mm WIDTH	H:720mm CODE	D:300mm WIDTH	H:720mm CODE	D:300mm WIDTH	H:720mm CODE	D:300mm WIDTH
RWU26-7	260	R2WU60-7*	600	RWG50-7	500	RCWD60-7	600x600	RCWL60-7	600x600	RWU30-7	300	RAWU360-7	360	RCWDU30-7	300x300
RWU30-7	300	RWU70-7#	700	RWG10-7	1000	Add 'X' to the end of the code for 350mm deep [650x650]		Add 'X' to the end of the code for 350mm deep [650x650]		Add 'X' to the end of the code for 350mm deep		Add 'X' to the end of the code for 350mm deep		Add 'X' to the end of the code for 350mm deep	
RWU35-7	350	RWU80-7#	800	Add 'X' to the end of the code for 350mm deep											
RWU40-7	400	RWU90-7#	900												
RWU45-7	450	RWU10-7#	1000												
RWU50-7	500	*No muntin [2x300 doors]													
RWU60-7#	600	# 2 x Doors													
Add 'X' to the end of the code for 350mm deep															

MEDIUM WALL TALL WALL HORIZONTAL WALL

Bi-Fold		Glazed Door		Diagonal Corner		Splayed		Boiler Wall		HORIZONTAL WALL			
H:720mm CODE	D:300mm WIDTH	H:900mm CODE	D:300mm WIDTH	H:900mm CODE	D:300mm WIDTH	H:900mm CODE	D:300mm WIDTH	H:900mm CODE	WIDTH	H:290mm CODE	WIDTH	H:360mm CODE	WIDTH
RBFWU50-7	500	RWU30-9	300	R2WU60-9*	600	RWG50-9	500	RCWD60-9	600x600	RAWU360-9	360	BWU6040-9	600
RBFWU60-7	600	RWU40-9	400	RWU80-9#	800	RWG10-9	1000	Add 'X' to the end of the code for 350mm deep [650x650]		Add 'X' to the end of the code for 350mm deep		Add 'X' to the end of the code for 350mm deep	
RBFWU80-7	800	RWU45-9	450	RWU90-9#	900	Add 'X' to the end of the code for 350mm deep							
RBFWU90-7	900	RWU50-9	500	RWU10-9#	1000								
RBFWU10-7	1000	RWU60-9	600	*No muntin [2x300 doors] # 2 x Doors									
Add 'X' to the end of the code for 350mm deep													





SHAKER

PRICE GROUP 6 + 8

# FARRINGTON

PAINT TO ORDER



Special sizes available  
contact us for further information

PTO Colours Options [PG6]: Calico, Dark Blue, Dark Green,  
Graphite, Light Grey, Luna and Porcelain.

Oak [PG8]

Bespoke Colour Option [PG8]



## HI-LINE BASE

## LOW BASE

<p>H:720mm</p> <table border="1"> <thead> <tr> <th>CODE</th> <th>WIDTH</th> <th>CODE</th> <th>WIDTH</th> </tr> </thead> <tbody> <tr><td>RBA15</td><td>150</td><td>R2BA60*</td><td>600</td></tr> <tr><td>RBA26</td><td>260</td><td>RBA70#</td><td>700</td></tr> <tr><td>RBA30</td><td>300</td><td>RBA80#</td><td>800</td></tr> <tr><td>RBA35</td><td>350</td><td>RBA90#</td><td>900</td></tr> <tr><td>RBA40</td><td>400</td><td>RBA10#</td><td>1000</td></tr> <tr><td>RBA45</td><td>450</td><td>RBA12#</td><td>1200</td></tr> <tr><td>RBA50</td><td>500</td><td colspan="2">*No muntin [2x300 doors]</td></tr> <tr><td>RBA60</td><td>600</td><td colspan="2"># 2 x Doors</td></tr> </tbody> </table>		CODE	WIDTH	CODE	WIDTH	RBA15	150	R2BA60*	600	RBA26	260	RBA70#	700	RBA30	300	RBA80#	800	RBA35	350	RBA90#	900	RBA40	400	RBA10#	1000	RBA45	450	RBA12#	1200	RBA50	500	*No muntin [2x300 doors]		RBA60	600	# 2 x Doors		<p>H:720mm</p> <table border="1"> <thead> <tr> <th>CODE</th> <th>WIDTH</th> <th>CODE</th> <th>WIDTH</th> </tr> </thead> <tbody> <tr><td>RBISPO15</td><td>150</td><td>RBA360</td><td>360</td></tr> </tbody> </table> <p>Standard Mechanism inc.</p>		CODE	WIDTH	CODE	WIDTH	RBISPO15	150	RBA360	360	<p>H:720mm</p> <table border="1"> <thead> <tr> <th>CODE</th> <th>WIDTH</th> <th>CODE</th> <th>WIDTH</th> </tr> </thead> <tbody> <tr><td>RSBU30</td><td>300</td><td>RSBU70#</td><td>700</td></tr> <tr><td>RSBU35</td><td>350</td><td>RSBU80#</td><td>800</td></tr> <tr><td>RSBU40</td><td>400</td><td>RSBU90#</td><td>900</td></tr> <tr><td>RSBU45</td><td>450</td><td>RSBU10#</td><td>1000</td></tr> <tr><td>RSBU50</td><td>500</td><td colspan="2">#2 x Doors</td></tr> <tr><td>RSBU60</td><td>600</td><td colspan="2"></td></tr> </tbody> </table> <p>Kesseböhmer Mechanism inc.</p>		CODE	WIDTH	CODE	WIDTH	RSBU30	300	RSBU70#	700	RSBU35	350	RSBU80#	800	RSBU40	400	RSBU90#	900	RSBU45	450	RSBU10#	1000	RSBU50	500	#2 x Doors		RSBU60	600			<p>H:720mm</p> <table border="1"> <thead> <tr> <th>CODE</th> <th>WIDTH</th> <th>CODE</th> <th>WIDTH</th> </tr> </thead> <tbody> <tr><td>RLBU30</td><td>300</td><td>RLBU80#</td><td>800</td></tr> <tr><td>RLBU40</td><td>400</td><td>RLBU90#</td><td>900</td></tr> <tr><td>RLBU45</td><td>450</td><td>RLBU10#</td><td>1000</td></tr> <tr><td>RLBU50</td><td>500</td><td>RLBU12#</td><td>1200</td></tr> <tr><td>RLBU60</td><td>600</td><td colspan="2"># 2 x Doors</td></tr> </tbody> </table>				CODE	WIDTH	CODE	WIDTH	RLBU30	300	RLBU80#	800	RLBU40	400	RLBU90#	900	RLBU45	450	RLBU10#	1000	RLBU50	500	RLBU12#	1200	RLBU60	600	# 2 x Doors	
CODE	WIDTH	CODE	WIDTH																																																																																																						
RBA15	150	R2BA60*	600																																																																																																						
RBA26	260	RBA70#	700																																																																																																						
RBA30	300	RBA80#	800																																																																																																						
RBA35	350	RBA90#	900																																																																																																						
RBA40	400	RBA10#	1000																																																																																																						
RBA45	450	RBA12#	1200																																																																																																						
RBA50	500	*No muntin [2x300 doors]																																																																																																							
RBA60	600	# 2 x Doors																																																																																																							
CODE	WIDTH	CODE	WIDTH																																																																																																						
RBISPO15	150	RBA360	360																																																																																																						
CODE	WIDTH	CODE	WIDTH																																																																																																						
RSBU30	300	RSBU70#	700																																																																																																						
RSBU35	350	RSBU80#	800																																																																																																						
RSBU40	400	RSBU90#	900																																																																																																						
RSBU45	450	RSBU10#	1000																																																																																																						
RSBU50	500	#2 x Doors																																																																																																							
RSBU60	600																																																																																																								
CODE	WIDTH	CODE	WIDTH																																																																																																						
RLBU30	300	RLBU80#	800																																																																																																						
RLBU40	400	RLBU90#	900																																																																																																						
RLBU45	450	RLBU10#	1000																																																																																																						
RLBU50	500	RLBU12#	1200																																																																																																						
RLBU60	600	# 2 x Doors																																																																																																							

## HI-LINE CORNER BASE

## DRAWERLINE BASE

## DRAWERLINE SINK BASE

## CERAMIC SINK BASE

<p>H:720mm</p> <table border="1"> <thead> <tr> <th>CODE</th> <th>WIDTH</th> <th>CODE</th> <th>WIDTH</th> </tr> </thead> <tbody> <tr><td>BAC90</td><td>900x900</td><td>CDA90</td><td>900x900</td></tr> </tbody> </table> <p>Bi-fold hinge system Flat pack</p>		CODE	WIDTH	CODE	WIDTH	BAC90	900x900	CDA90	900x900	<p>H:720mm</p> <table border="1"> <thead> <tr> <th>CODE</th> <th>WIDTH</th> <th>CODE</th> <th>WIDTH</th> </tr> </thead> <tbody> <tr><td>RBAC830</td><td>800/300</td><td>RBAC950</td><td>900/500</td></tr> <tr><td>RBAC80</td><td>800/400</td><td>RBAC960</td><td>900/600</td></tr> <tr><td>RBAC845</td><td>800/450</td><td>RBAC140</td><td>1000/400</td></tr> <tr><td>RBAC850</td><td>800/500</td><td>RBAC145</td><td>1000/450</td></tr> <tr><td>RBAC860</td><td>800/600</td><td>RBAC10</td><td>1000/500</td></tr> <tr><td>RBAC940</td><td>900/400</td><td>RBAC160</td><td>1000/600</td></tr> <tr><td>RBAC945</td><td>900/450</td><td>RBAC12</td><td>1200/600</td></tr> </tbody> </table> <p>Inc. Corner Post &amp; Blanking Panel</p>		CODE	WIDTH	CODE	WIDTH	RBAC830	800/300	RBAC950	900/500	RBAC80	800/400	RBAC960	900/600	RBAC845	800/450	RBAC140	1000/400	RBAC850	800/500	RBAC145	1000/450	RBAC860	800/600	RBAC10	1000/500	RBAC940	900/400	RBAC160	1000/600	RBAC945	900/450	RBAC12	1200/600	<p>H:720mm</p> <table border="1"> <thead> <tr> <th>CODE</th> <th>WIDTH</th> <th>CODE</th> <th>WIDTH</th> </tr> </thead> <tbody> <tr><td>RBD30</td><td>300</td><td>RBD80/1</td><td>800</td></tr> <tr><td>RBD40</td><td>400</td><td>RBD90/1</td><td>900</td></tr> <tr><td>RBD45</td><td>450</td><td>RBD10/1</td><td>1000</td></tr> <tr><td>RBD50</td><td>500</td><td></td><td></td></tr> <tr><td>RBD60</td><td>600</td><td></td><td></td></tr> <tr><td>RBD80#</td><td>800</td><td></td><td></td></tr> <tr><td>RBD90#</td><td>900</td><td></td><td></td></tr> <tr><td>RBD10#</td><td>1000</td><td></td><td></td></tr> <tr><td>RBD12#</td><td>1200</td><td></td><td></td></tr> </tbody> </table> <p># 2 x Doors</p>				CODE	WIDTH	CODE	WIDTH	RBD30	300	RBD80/1	800	RBD40	400	RBD90/1	900	RBD45	450	RBD10/1	1000	RBD50	500			RBD60	600			RBD80#	800			RBD90#	900			RBD10#	1000			RBD12#	1200			<p>H:720mm</p> <table border="1"> <thead> <tr> <th>CODE</th> <th>WIDTH</th> <th>CODE</th> <th>WIDTH</th> </tr> </thead> <tbody> <tr><td>RBDF50</td><td>500</td><td>RBSU60</td><td>600x460</td></tr> <tr><td>RBDF60</td><td>600</td><td colspan="2">To suit a sink height of 260mm</td></tr> <tr><td>RBDF80#</td><td>800</td><td></td><td></td></tr> <tr><td>RBDF90#</td><td>900</td><td></td><td></td></tr> <tr><td>RBDF10#</td><td>1000</td><td></td><td></td></tr> <tr><td>RBDD10*#</td><td>1000</td><td></td><td></td></tr> <tr><td>RBDD12*#</td><td>1200</td><td></td><td></td></tr> </tbody> </table> <p>*One working drawer # 2 x Doors</p>		CODE	WIDTH	CODE	WIDTH	RBDF50	500	RBSU60	600x460	RBDF60	600	To suit a sink height of 260mm		RBDF80#	800			RBDF90#	900			RBDF10#	1000			RBDD10*#	1000			RBDD12*#	1200		
CODE	WIDTH	CODE	WIDTH																																																																																																																						
BAC90	900x900	CDA90	900x900																																																																																																																						
CODE	WIDTH	CODE	WIDTH																																																																																																																						
RBAC830	800/300	RBAC950	900/500																																																																																																																						
RBAC80	800/400	RBAC960	900/600																																																																																																																						
RBAC845	800/450	RBAC140	1000/400																																																																																																																						
RBAC850	800/500	RBAC145	1000/450																																																																																																																						
RBAC860	800/600	RBAC10	1000/500																																																																																																																						
RBAC940	900/400	RBAC160	1000/600																																																																																																																						
RBAC945	900/450	RBAC12	1200/600																																																																																																																						
CODE	WIDTH	CODE	WIDTH																																																																																																																						
RBD30	300	RBD80/1	800																																																																																																																						
RBD40	400	RBD90/1	900																																																																																																																						
RBD45	450	RBD10/1	1000																																																																																																																						
RBD50	500																																																																																																																								
RBD60	600																																																																																																																								
RBD80#	800																																																																																																																								
RBD90#	900																																																																																																																								
RBD10#	1000																																																																																																																								
RBD12#	1200																																																																																																																								
CODE	WIDTH	CODE	WIDTH																																																																																																																						
RBDF50	500	RBSU60	600x460																																																																																																																						
RBDF60	600	To suit a sink height of 260mm																																																																																																																							
RBDF80#	800																																																																																																																								
RBDF90#	900																																																																																																																								
RBDF10#	1000																																																																																																																								
RBDD10*#	1000																																																																																																																								
RBDD12*#	1200																																																																																																																								

## DRAWERLINE CORNER BASE

## BUILT UNDER

## 2 DRAWER BASE

## 3 DRAWER BASE

## 4 DRAWER BASE

## 5 DRAWER BASE

## LOW WALL

<p>H:720mm</p> <table border="1"> <thead> <tr> <th>CODE</th> <th>WIDTH</th> <th>CODE</th> <th>WIDTH</th> </tr> </thead> <tbody> <tr><td>RBDC830</td><td>800/300</td><td>RBDC140</td><td>1000/400</td></tr> <tr><td>RBDC80</td><td>800/400</td><td>RBDC145</td><td>1000/450</td></tr> <tr><td>RBDC845</td><td>800/450</td><td>RBDC10</td><td>1000/500</td></tr> <tr><td>RBDC850</td><td>800/500</td><td>RBDC160</td><td>1000/600</td></tr> <tr><td>RBDC860</td><td>800/600</td><td>RBDC12</td><td>1200/600</td></tr> </tbody> </table> <p>Inc. Corner Post &amp; Blanking Panel</p>		CODE	WIDTH	CODE	WIDTH	RBDC830	800/300	RBDC140	1000/400	RBDC80	800/400	RBDC145	1000/450	RBDC845	800/450	RBDC10	1000/500	RBDC850	800/500	RBDC160	1000/600	RBDC860	800/600	RBDC12	1200/600	<p>H:720mm</p> <table border="1"> <thead> <tr> <th>CODE</th> <th>WIDTH</th> </tr> </thead> <tbody> <tr><td>RBUE060</td><td>600</td></tr> </tbody> </table> <p>Oven</p>		CODE	WIDTH	RBUE060	600	<p>H:720mm</p> <table border="1"> <thead> <tr> <th>CODE</th> <th>WIDTH</th> </tr> </thead> <tbody> <tr><td>RBD250</td><td>500</td></tr> <tr><td>RBD260</td><td>600</td></tr> <tr><td>RBD280</td><td>800</td></tr> <tr><td>RBD290</td><td>900</td></tr> <tr><td>RBD210</td><td>1000</td></tr> </tbody> </table> <p>2x355mm Drawers</p>		CODE	WIDTH	RBD250	500	RBD260	600	RBD280	800	RBD290	900	RBD210	1000	<p>H:720mm</p> <table border="1"> <thead> <tr> <th>CODE</th> <th>WIDTH</th> </tr> </thead> <tbody> <tr><td>RBD350</td><td>500</td></tr> <tr><td>RBD360</td><td>600</td></tr> <tr><td>RBD380</td><td>800</td></tr> <tr><td>RBD390</td><td>900</td></tr> <tr><td>RBD310</td><td>1000</td></tr> </tbody> </table> <p>1x140mm, 1x283mm Drawers</p>		CODE	WIDTH	RBD350	500	RBD360	600	RBD380	800	RBD390	900	RBD310	1000	<p>H:720mm</p> <table border="1"> <thead> <tr> <th>CODE</th> <th>WIDTH</th> </tr> </thead> <tbody> <tr><td>RBD450</td><td>500</td></tr> <tr><td>RBD460</td><td>600</td></tr> <tr><td>RBD480</td><td>800</td></tr> <tr><td>RBD490</td><td>900</td></tr> <tr><td>RBD410</td><td>1000</td></tr> </tbody> </table> <p>3x140mm, 1x283mm drawers</p>		CODE	WIDTH	RBD450	500	RBD460	600	RBD480	800	RBD490	900	RBD410	1000	<p>H:720mm</p> <table border="1"> <thead> <tr> <th>CODE</th> <th>WIDTH</th> </tr> </thead> <tbody> <tr><td>RBD530</td><td>300</td></tr> <tr><td>RBD540</td><td>400</td></tr> <tr><td>RBD545</td><td>450</td></tr> <tr><td>RBD550</td><td>500</td></tr> <tr><td>RBD560</td><td>600</td></tr> <tr><td>RBD580</td><td>800</td></tr> <tr><td>RBD590</td><td>900</td></tr> <tr><td>RBD510</td><td>1000</td></tr> </tbody> </table> <p>5x140mm Drawers</p>		CODE	WIDTH	RBD530	300	RBD540	400	RBD545	450	RBD550	500	RBD560	600	RBD580	800	RBD590	900	RBD510	1000	<p>H:720mm</p> <table border="1"> <thead> <tr> <th>CODE</th> <th>WIDTH</th> <th>CODE</th> <th>WIDTH</th> </tr> </thead> <tbody> <tr><td>RWU30-5</td><td>300</td><td>R2WU60-5*#</td><td>600</td></tr> <tr><td>RWU40-5</td><td>400</td><td>RWU80-5#</td><td>800</td></tr> <tr><td>RWU45-5</td><td>450</td><td>RWU90-5#</td><td>900</td></tr> <tr><td>RWU50-5</td><td>500</td><td>RWU10-5#</td><td>1000</td></tr> <tr><td>RWU60-5</td><td>600</td><td colspan="2">*No muntin [2 x 300 doors]</td></tr> </tbody> </table> <p># 2 x Doors</p>		CODE	WIDTH	CODE	WIDTH	RWU30-5	300	R2WU60-5*#	600	RWU40-5	400	RWU80-5#	800	RWU45-5	450	RWU90-5#	900	RWU50-5	500	RWU10-5#	1000	RWU60-5	600	*No muntin [2 x 300 doors]	
CODE	WIDTH	CODE	WIDTH																																																																																																																				
RBDC830	800/300	RBDC140	1000/400																																																																																																																				
RBDC80	800/400	RBDC145	1000/450																																																																																																																				
RBDC845	800/450	RBDC10	1000/500																																																																																																																				
RBDC850	800/500	RBDC160	1000/600																																																																																																																				
RBDC860	800/600	RBDC12	1200/600																																																																																																																				
CODE	WIDTH																																																																																																																						
RBUE060	600																																																																																																																						
CODE	WIDTH																																																																																																																						
RBD250	500																																																																																																																						
RBD260	600																																																																																																																						
RBD280	800																																																																																																																						
RBD290	900																																																																																																																						
RBD210	1000																																																																																																																						
CODE	WIDTH																																																																																																																						
RBD350	500																																																																																																																						
RBD360	600																																																																																																																						
RBD380	800																																																																																																																						
RBD390	900																																																																																																																						
RBD310	1000																																																																																																																						
CODE	WIDTH																																																																																																																						
RBD450	500																																																																																																																						
RBD460	600																																																																																																																						
RBD480	800																																																																																																																						
RBD490	900																																																																																																																						
RBD410	1000																																																																																																																						
CODE	WIDTH																																																																																																																						
RBD530	300																																																																																																																						
RBD540	400																																																																																																																						
RBD545	450																																																																																																																						
RBD550	500																																																																																																																						
RBD560	600																																																																																																																						
RBD580	800																																																																																																																						
RBD590	900																																																																																																																						
RBD510	1000																																																																																																																						
CODE	WIDTH	CODE	WIDTH																																																																																																																				
RWU30-5	300	R2WU60-5*#	600																																																																																																																				
RWU40-5	400	RWU80-5#	800																																																																																																																				
RWU45-5	450	RWU90-5#	900																																																																																																																				
RWU50-5	500	RWU10-5#	1000																																																																																																																				
RWU60-5	600	*No muntin [2 x 300 doors]																																																																																																																					

<p>H:720mm</p> <table border="1"> <thead> <tr> <th>CODE</th> <th>WIDTH</th> <th>CODE</th> <th>WIDTH</th> </tr> </thead> <tbody> <tr><td>RWU26-7</td><td>260</td><td>R2WU60-7*#</td><td>600</td></tr> <tr><td>RWU30-7</td><td>300</td><td>RWU70-7#</td><td>700</td></tr> <tr><td>RWU35-7</td><td>350</td><td>RWU80-7#</td><td>800</td></tr> <tr><td>RWU40-7</td><td>400</td><td>RWU90-7#</td><td>900</td></tr> <tr><td>RWU45-7</td><td>450</td><td>RWU10-7#</td><td>1000</td></tr> <tr><td>RWU50-7</td><td>500</td><td colspan="2">*No muntin [2x300 doors]</td></tr> <tr><td>RWU60-7#</td><td>600</td><td colspan="2"># 2 x Doors</td></tr> </tbody> </table> <p>Add 'X' to the end of the code for 350mm deep</p>		CODE	WIDTH	CODE	WIDTH	RWU26-7	260	R2WU60-7*#	600	RWU30-7	300	RWU70-7#	700	RWU35-7	350	RWU80-7#	800	RWU40-7	400	RWU90-7#	900	RWU45-7	450	RWU10-7#	1000	RWU50-7	500	*No muntin [2x300 doors]		RWU60-7#	600	# 2 x Doors		<p>H:720mm</p> <table border="1"> <thead> <tr> <th>CODE</th> <th>WIDTH</th> <th>CODE</th> <th>WIDTH</th> </tr> </thead> <tbody> <tr><td>RWG50-7**</td><td>500</td><td>RWG10-7**</td><td>1000</td></tr> </tbody> </table> <p>*Door style 79mm Shaker frame •Not Oak</p>		CODE	WIDTH	CODE	WIDTH	RWG50-7**	500	RWG10-7**	1000	<p>H:720mm</p> <table border="1"> <thead> <tr> <th>CODE</th> <th>WIDTH</th> <th>CODE</th> <th>WIDTH</th> </tr> </thead> <tbody> <tr><td>RCWD60-7</td><td>600x600</td><td>RCWL60-7</td><td>600x600</td></tr> </tbody> </table> <p>Add 'X' to the end of the code for 350mm deep [650x650]</p>		CODE	WIDTH	CODE	WIDTH	RCWD60-7	600x600	RCWL60-7	600x600	<p>H:720mm</p> <table border="1"> <thead> <tr> <th>CODE</th> <th>WIDTH</th> <th>CODE</th> <th>WIDTH</th> </tr> </thead> <tbody> <tr><td>RWU60-7</td><td>600</td><td>RAWU360-7</td><td>360</td></tr> </tbody> </table> <p>Inc. Corner Post Add 'X' to the end of the code for 350mm deep</p>		CODE	WIDTH	CODE	WIDTH	RWU60-7	600	RAWU360-7	360	<p>H:720mm</p> <table border="1"> <thead> <tr> <th>CODE</th> <th>WIDTH</th> <th>CODE</th> <th>WIDTH</th> </tr> </thead> <tbody> <tr><td>RAWU360-7</td><td>360</td><td>RMWU60-7</td><td>600</td></tr> </tbody> </table> <p>Add 'X' to the end of the code for 350mm deep</p>		CODE	WIDTH	CODE	WIDTH	RAWU360-7	360	RMWU60-7	600	<p>H:720mm</p> <table border="1"> <thead> <tr> <th>CODE</th> <th>WIDTH</th> <th>CODE</th> <th>WIDTH</th> </tr> </thead> <tbody> <tr><td>RMWU60-7</td><td>600</td><td>RBFWU50-7</td><td>500</td></tr> <tr><td></td><td></td><td>RBFWU60-7</td><td>600</td></tr> <tr><td></td><td></td><td>RBFWU80-7</td><td>800</td></tr> <tr><td></td><td></td><td>RBFWU90-7</td><td>900</td></tr> <tr><td></td><td></td><td>RBFWU10-7</td><td>1000</td></tr> </tbody> </table> <p>283mm flap, 110mm filler; Mechanism inc Add 'X' to the end of the code for 350mm deep</p>		CODE	WIDTH	CODE	WIDTH	RMWU60-7	600	RBFWU50-7	500			RBFWU60-7	600			RBFWU80-7	800			RBFWU90-7	900			RBFWU10-7	1000
CODE	WIDTH	CODE	WIDTH																																																																																																
RWU26-7	260	R2WU60-7*#	600																																																																																																
RWU30-7	300	RWU70-7#	700																																																																																																
RWU35-7	350	RWU80-7#	800																																																																																																
RWU40-7	400	RWU90-7#	900																																																																																																
RWU45-7	450	RWU10-7#	1000																																																																																																
RWU50-7	500	*No muntin [2x300 doors]																																																																																																	
RWU60-7#	600	# 2 x Doors																																																																																																	
CODE	WIDTH	CODE	WIDTH																																																																																																
RWG50-7**	500	RWG10-7**	1000																																																																																																
CODE	WIDTH	CODE	WIDTH																																																																																																
RCWD60-7	600x600	RCWL60-7	600x600																																																																																																
CODE	WIDTH	CODE	WIDTH																																																																																																
RWU60-7	600	RAWU360-7	360																																																																																																
CODE	WIDTH	CODE	WIDTH																																																																																																
RAWU360-7	360	RMWU60-7	600																																																																																																
CODE	WIDTH	CODE	WIDTH																																																																																																
RMWU60-7	600	RBFWU50-7	500																																																																																																
		RBFWU60-7	600																																																																																																
		RBFWU80-7	800																																																																																																
		RBFWU90-7	900																																																																																																
		RBFWU10-7	1000																																																																																																





## TALL WALL

## HORIZONTAL WALL

## GLAZED DRESSER

<p>H:900mm</p> <table border="1"> <thead> <tr> <th>CODE</th> <th>WIDTH</th> <th>CODE</th> <th>WIDTH</th> </tr> </thead> <tbody> <tr><td>RWU30-9</td><td>300</td><td>R2WU60-9*#</td><td>600</td></tr> <tr><td>RWU40-9</td><td>400</td><td>RWU80-9#</td><td>800</td></tr> <tr><td>RWU45-9</td><td>450</td><td>RWU90-9#</td><td>900</td></tr> <tr><td>RWU50-9</td><td>500</td><td>RWU10-9#</td><td>1000</td></tr> <tr><td>RWU60-9</td><td>600</td><td colspan="2">*No muntin [2x300 doors]</td></tr> </tbody> </table> <p>Add 'X' to the end of the code for 350mm deep</p>		CODE	WIDTH	CODE	WIDTH	RWU30-9	300	R2WU60-9*#	600	RWU40-9	400	RWU80-9#	800	RWU45-9	450	RWU90-9#	900	RWU50-9	500	RWU10-9#	1000	RWU60-9	600	*No muntin [2x300 doors]		<p>D:300mm</p> <table border="1"> <thead> <tr> <th>CODE</th> <th>WIDTH</th> <th>CODE</th> <th>WIDTH</th> </tr> </thead> <tbody> <tr><td>RGW50-9**</td><td>500</td><td>RGW10-9**</td><td>1000</td></tr> </tbody> </table> <p>*Door style 79mm Shaker frame •Not Oak</p>		CODE	WIDTH	CODE	WIDTH	RGW50-9**	500	RGW10-9**	1000	<p>H:900mm</p> <table border="1"> <thead> <tr> <th>CODE</th> <th>WIDTH</th> <th>CODE</th> <th>WIDTH</th> </tr> </thead> <tbody> <tr><td>RCWD60-9</td><td>600x600</td><td>RAWU360-9</td><td>360</td></tr> </tbody> </table> <p>Add 'X' to the end of the code for 350mm deep [650x650]</p>		CODE	WIDTH	CODE	WIDTH	RCWD60-9	600x600	RAWU360-9	360	<p>H:900mm</p> <table border="1"> <thead> <tr> <th>CODE</th> <th>WIDTH</th> <th>CODE</th> <th>WIDTH</th> </tr> </thead> <tbody> <tr><td>BWU6040-9</td><td>600</td></tr> </tbody> </table> <p>400mm Deep Flat pack</p>		CODE	WIDTH	CODE	WIDTH	BWU6040-9	600	<p>H:290mm</p> <table border="1"> <thead> <tr> <th>CODE</th> <th>WIDTH</th> <th>CODE</th> <th>WIDTH</th> </tr> </thead> <tbody> <tr><td>RHWU5029</td><td>500</td><td>RDR2/50*#</td><td>500</td></tr> <tr><td>RHWU6029</td><td>600</td><td colspan="2">1 Drawer</td></tr> <tr><td>RHWU8029</td><td>800</td><td colspan="2">*Door style 79mm</td></tr> <tr><td>RHWU9029</td><td>900</td><td colspan="2">Shaker frame</td></tr> <tr><td>RHWU1029</td><td>1000</td><td colspan="2">•Not Oak</td></tr> <tr><td>RHWU5036*</td><td>500</td><td colspan="2">Add 'X' to the end of the code for 350mm deep</td></tr> <tr><td>RHWU6036*</td><td>600</td><td colspan="2"></td></tr> <tr><td>RHWU8036*</td><td>800</td><td colspan="2"></td></tr> <tr><td>RHWU1036*</td><td>900</td><td colspan="2"></td></tr> <tr><td>RHWU1036*</td><td>1000</td><td colspan="2"></td></tr> </tbody> </table> <p>Add 'X' to the end of the code for 350mm deep</p>		CODE	WIDTH	CODE	WIDTH	RHWU5029	500	RDR2/50*#	500	RHWU6029	600	1 Drawer		RHWU8029	800	*Door style 79mm		RHWU9029	900	Shaker frame		RHWU1029	1000	•Not Oak		RHWU5036*	500	Add 'X' to the end of the code for 350mm deep		RHWU6036*	600			RHWU8036*	800			RHWU1036*	900			RHWU1036*	1000		
CODE	WIDTH	CODE	WIDTH																																																																																																
RWU30-9	300	R2WU60-9*#	600																																																																																																
RWU40-9	400	RWU80-9#	800																																																																																																
RWU45-9	450	RWU90-9#	900																																																																																																
RWU50-9	500	RWU10-9#	1000																																																																																																
RWU60-9	600	*No muntin [2x300 doors]																																																																																																	
CODE	WIDTH	CODE	WIDTH																																																																																																
RGW50-9**	500	RGW10-9**	1000																																																																																																
CODE	WIDTH	CODE	WIDTH																																																																																																
RCWD60-9	600x600	RAWU360-9	360																																																																																																
CODE	WIDTH	CODE	WIDTH																																																																																																
BWU6040-9	600																																																																																																		
CODE	WIDTH	CODE	WIDTH																																																																																																
RHWU5029	500	RDR2/50*#	500																																																																																																
RHWU6029	600	1 Drawer																																																																																																	
RHWU8029	800	*Door style 79mm																																																																																																	
RHWU9029	900	Shaker frame																																																																																																	
RHWU1029	1000	•Not Oak																																																																																																	
RHWU5036*	500	Add 'X' to the end of the code for 350mm deep																																																																																																	
RHWU6036*	600																																																																																																		
RHWU8036*	800																																																																																																		
RHWU1036*	900																																																																																																		
RHWU1036*	1000																																																																																																		

OPEN WALL

				
H:290mm CODE <b>RWOS50-2</b> 500 <b>RWOS60-2</b> 600 <b>RWOS80-2</b> 800 <b>RWOS90-2</b> 900 <b>RWOS10-2</b> 1000 MFC Carcase  If 350mm deep carcase is required adjust code, e.g RWOS1035-2	H:360mm CODE <b>RWOS50-3</b> 500 <b>RWOS60-3</b> 600 <b>RWOS80-3</b> 800 <b>RWOS90-3</b> 900 <b>RWOS10-3</b> 1000 MFC Carcase  If 350mm deep carcase is required adjust code, e.g RWOS1035-3	H:575mm CODE <b>RWOS30-5</b> 300 <b>RWOS40-5</b> 400 <b>RWOS45-5</b> 450 <b>RWOS50-5</b> 500 <b>RWOS60-5</b> 600 <b>RWOS80-5</b> 800 <b>RWOS90-5</b> 900 <b>RWOS10-5</b> 1000 MFC Carcase  If 350mm deep carcase is required adjust code, e.g RWOS1035-5	H:720mm CODE <b>RWOS30-7</b> 300 <b>RWOS40-7</b> 400 <b>RWOS45-7</b> 450 <b>RWOS50-7</b> 500 <b>RWOS60-7</b> 600 <b>RWOS80-7</b> 800 <b>RWOS90-7</b> 900 <b>RWOS10-7</b> 1000 MFC Carcase  If 350mm deep carcase is required adjust code, e.g RWOS1035-7	H:900mm CODE <b>RWOS30-9</b> 300 <b>RWOS40-9</b> 400 <b>RWOS45-9</b> 450 <b>RWOS50-9</b> 500 <b>RWOS60-9</b> 600 <b>RWOS80-9</b> 800 <b>RWOS90-9</b> 900 <b>RWOS10-9</b> 1000 <b>RDC1/50</b> 500 <b>RDC1/60</b> 600 MFC Carcase  If 350mm deep carcase is required adjust code, e.g RWOS1035-9

MIDI UNITS

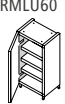
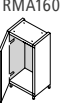
	
H:1250mm CODE <b>RMLU60</b> 600 <b>RMA160</b> 600  <b>RMD060</b> 600 <b>RMOH560</b> 600	H:1210mm CODE <b>RMLU60</b> 600 <b>RMA160</b> 600  <b>RMD060</b> 600 <b>RMOH560</b> 600

LARDER

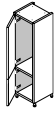
H:1970mm CODE <b>RTL030</b> 300 <b>RTLU40</b> 400 <b>RTLU50</b> 500 <b>RTLU60</b> 600 <b>TLU80</b> 800 <b>TLU10</b> 1000

LARDER

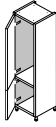
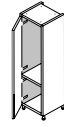
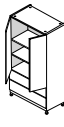
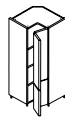
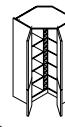
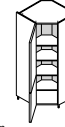
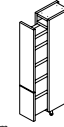
						
H:2150mm CODE <b>RETLU30</b> 300 <b>RETLU40</b> 400 <b>RETLU50</b> 500 <b>RETLU60</b> 600 <b>ETLU80</b> 800 <b>ETLU10</b> 1000 <b>RETLU60/1*</b> 600  *715mm bottom, 1425mm top door	Single Door - Two Cross Rails H:1970mm CODE <b>CRTLUSD30</b> 300 <b>CRTLUSD40</b> 400 <b>CRTLUSD50</b> 500 <b>CRTLUSD60</b> 600	Drawer Larder H:1970mm CODE <b>TDLU80</b> 800 <b>TDLU10</b> 1000 2x355mm drawers	'L' Shaped H:1970mm CODE <b>TCLU98</b> 985x985 <b>ETLU98*</b> 985x985 Bi-fold hinge system	Diagonal Walk-in Larder H:1970mm CODE <b>TDWIL1144</b> 1144x1144 <b>ETDWIL1144*</b> 1144x1144	Diagonal H:1970mm CODE <b>TDCLU1003</b> 1003x1003 <b>ETDCLU1003*</b> 1003x1003	PULL-OUT LARDER H:1970mm CODE <b>RTISPOL30</b> 300 <b>RTKPOL30</b> 300 Standard Mechanism inc. <b>RETISPOL30*</b> 300 <b>RETKPOL30*</b> 300 Kessebohmer Mechanism inc.

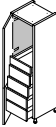
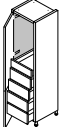

INNER DRAWER LARDER

	
H:1970mm CODE <b>RTLID30</b> 300 <b>RTLID40</b> 400 <b>RTLID50</b> 500 <b>RTLID60</b> 600 1 x Standard, 4 x Deep drawers	H:2150mm CODE <b>RETLID30</b> 300 <b>RETLID40</b> 400 <b>RETLID50</b> 500 <b>RETLID60</b> 600

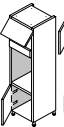
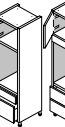
DOUBLE OVEN

	
H:1970mm CODE <b>RTOHD60</b> 600 <b>RTOHDD60</b> 600 <b>RETOHDD60*</b> 600	*H:2150mm CODE <b>RTOHS60</b> 600 <b>RTOHS60*</b> 600

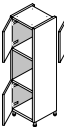
SINGLE OVEN

	
H:1970mm CODE <b>RTOHS60</b> 600 <b>RTOHS60*</b> 600	*H:2150mm CODE <b>RTOHS60</b> 600 <b>RTOHS60*</b> 600

SINGLE OVEN + COMPACT

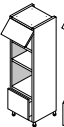
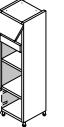
	
H:1970mm CODE <b>RTOHC60</b> 600 <b>RETOHC60*</b> 600	*H:2150mm CODE <b>RTOHC60</b> 600 <b>RETOHC60*</b> 600

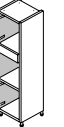

COMPACT

	
H:1970mm CODE <b>RTOHC60</b> 600 <b>RETOHC60*</b> 600	*H:2150mm CODE <b>RTOHC60</b> 600 <b>RETOHC60*</b> 600

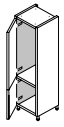
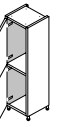
TALL FRIDGE/FREEZER

	
H:1970mm CODE <b>RTFF1/60</b> 600 <b>RTFF4/60*</b> 600 <b>RTFF1U/60#</b> 600 <b>RTFF4U/60#</b> 600 *Doors undrilled #For door on door appliances	H:1970mm CODE <b>RTISPOL30</b> 300 <b>RTKPOL30</b> 300 Standard Mechanism inc. <b>RETISPOL30*</b> 300 <b>RETKPOL30*</b> 300 Kessebohmer Mechanism inc.

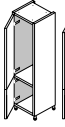

TALL FRIDGE/FREEZER

	
H:2150mm CODE <b>RETFF1/60</b> 600 <b>RETFF2/60</b> 600 <b>RETFF3/60*</b> 600 <b>RETFF1U/60#</b> 600 <b>RETFF2U/60#</b> 600 <b>RETFF3U/60#</b> 600 #For door on door appliances *715mm bottom, 1425mm top door	W:125mm / W:250mm* CODE <b>RWR125-7</b> 720 <b>RWR250-7*</b> 720 <b>RWR125-9</b> 900 <b>RWR250-9*</b> 900 <b>RWR125-1210</b> 1210 <b>WR125-1970</b> 1970 <b>WR250-1970</b> 1970 MFC Carcase If using as base order LEGSET

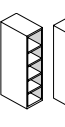
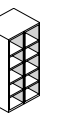

BOX WINE RACKS

	
H:900mm CODE <b>ESP</b> 600 <b>900/700</b> 700 MFC Carcase	W:125mm / W:250mm* CODE <b>RWR125-7</b> 720 <b>RWR250-7*</b> 720 <b>RWR125-9</b> 900 <b>RWR250-9*</b> 900 <b>RWR125-1210</b> 1210 <b>WR125-1970</b> 1970 <b>WR250-1970</b> 1970 MFC Carcase If using as base order LEGSET



END SUPPORT PANELS

	
H:900mm CODE <b>ESP</b> 600 <b>900/700</b> 700 MFC Carcase	W:125mm / W:250mm* CODE <b>RWR125-7</b> 720 <b>RWR250-7*</b> 720 <b>RWR125-9</b> 900 <b>RWR250-9*</b> 900 <b>RWR125-1210</b> 1210 <b>WR125-1970</b> 1970 <b>WR250-1970</b> 1970 MFC Carcase If using as base order LEGSET



CARCASE MFC PANELS

	
H:18mm CODE <b>PCM/MP</b> Painted <b>PL/MOA</b> Oak	D:70mm LENGTH <b>PCM/MP</b> 3000 <b>PL/MOA</b> 2400



CORNICE/PELMET

	
H:18mm CODE <b>PCM/MP</b> Painted <b>PL/MOA</b> Oak	D:70mm LENGTH <b>PCM/MP</b> 3000 <b>PL/MOA</b> 2400

PLINTH

	
H:150mm CODE <b>PL</b> 2940 <b>PL/MP</b> 3000 Painted <b>PL/MOA</b> 2400 Oak	W:150mm WIDTH <b>PL</b> 2940 <b>PL/MP</b> 3000 Melamine [Carcase MFC] <b>PL/MOA</b> 2400 Oak



Clear Sealing Strip

	
H:150mm CODE <b>PST</b> 3000	W:150mm WIDTH <b>PST</b> 3000



18mm Plain

H:1970mm CODE <b>2400/650P/MP</b> 650x2400 <b>800/375P/MP</b> 375x800 <b>900/650P/MP</b> 650x900 <b>960/375P/MP</b> 375x960 <b>900/1200P/MP</b> 1200x900 <b>900/2400P/MP</b> 2400x900 Painted <b>2400/650P/MOA</b> 650x2400 <b>800/375P/MOA</b> 375x800 <b>900/650P/MOA</b> 650x900 <b>960/375P/MOA</b> 375x960 <b>900/1200P/MOA</b> 1200x900 Oak



PLANT ON END PANELS

	
18mm Tongue & Grooved CODE <b>2400/650T/MP</b> 650x2400 <b>800/375T/MP</b> 375x800 <b>900/650T/MP</b> 650x900 <b>960/375T/MP</b> 375x960 <b>900/1200T/MP</b> 1200x900 <b>900/2200T/MP</b> 2200x900 Painted	18mm Reeded CODE <b>2400/650R/MP</b> 650x2400 <b>800/375R/MP</b> 375x800 <b>900/650R/MP</b> 650x900 <b>960/375R/MP</b> 375x960 <b>900/1200R/MP</b> 1200x900 <b>900/2200R/MP</b> 2200x900 Painted <b>2400/650R/MOA</b> 650x2400 <b>800/375R/MOA</b> 375x800 <b>900/650R/MOA</b> 650x900 <b>960/375R/MOA</b> 375x960 <b>900/1200R/MOA</b> 1200x900 Oak

PILASTERS

	
Square H:900mm CODE <b>PIL/S2400MP*</b> 50x75 <b>PIL/S900MP</b> 68x68 Square [painted only] <b>PIL/SC900MP</b> 68x68 Chamfered [painted only]	Chamfered H:900mm CODE <b>CP/MP**2</b> Painted <b>CP/MOA2</b> Oak Flat Panel for on site conversion

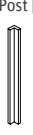
FURNITURE ACCESSORIES

	
Corner Post [Spare] H:715mm CODE <b>CP/MP**2</b> Painted <b>CP/MOA2</b> Oak Flat Panel for on site conversion	Door Hung Spice Rack H:1050mm CODE <b>DHSR/BNO</b> 350x106

INTEGRATED DOORS

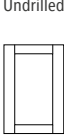
Undrilled CODE <b>INT4571</b> 446x715 <b>INT6071</b> 596x715

SPARE DOOR FITTINGS

Hinges [Hettich Soft Close] CODE <b>SCHINGE90</b> 90 degree [Pair] <b>SCHINGE170</b> 170 degree [Pair]	Stays [Blum Aventos] CODE <b>BLSTAYHKS</b> HK-S stay [Pair] *[inc mounting brackets]
--	--

GENERAL ACCS.

CODE <b>STPWN</b> Door Strapping Plates <b>LEGSET</b> Adjustable legs <b>SACC</b> 14mm Self Adhesive Cover Caps <b>PCC/MP</b> Painted Care Kit [not available for oak]	Set of 2 Set of 4 Pk 50
--	-------------------------------

SHAKER  
PRICE GROUP 7  
**FELTON**  
PAINT TO ORDER

Colours Options [PG7]: Antique Red, Black, Blush, Charcoal, Dark Sage, Dust Grey, Federal Blue, Fern, Gunmetal, Heritage Green, Hunter, Indigo, Ink, Light Grey, Midnight Blue, Mussel, Palladian Blue, Pebble, Porcelain, Sage, Stone Grey, Storm and Woodland Grey.



**HI-LINE BASE**

H:720mm  
CODE  
**RBA15** 150  
**RBA30** 300  
**RBA35** 350  
**RBA40** 400  
**RBA45** 450  
**RBA50** 500  
**RBA60** 600

Pull-Out

H:720mm  
CODE  
**R2BA60\*** 600  
**RBA70#** 700  
**RBA80#** 800  
**RBA90#** 900  
**RBA10#** 1000  
**RBA12#** 1200  
\*No muntin [2x300 doors]  
# 2 x Doors

Splayed

H:720mm  
CODE  
**RBISPO15** 150  
**RBABO15** 150  
**RBKPO15** 150  
**RBKTP015** 150  
Standard Mechanism inc.  
Kesseböhmer Mechanism inc.  
Kesseböhmer Mechanism & Towel rail inc.

LOW BASE

H:720mm  
CODE  
**RSBU30** 300  
**RSBU35** 350  
**RSBU40** 400  
**RSBU45** 450  
**RSBU50** 500  
**RSBU60** 600  
**RSBU70** 700  
**RSBU80** 800  
**RSBU90** 900  
**RSBU10** 1000

HI-LINE CORNER BASE

H:575mm  
CODE  
**RLBU30** 300  
**RLBU40** 400  
**RLBU45** 450  
**RLBU50** 500  
**RLBU60** 600  
**RLBU80#** 800  
**RLBU90#** 900  
**RLBU10#** 1000  
**RLBU12#** 1200  
# 2 x Doors

H:720mm  
CODE  
**RBAC830** 800/300  
**RBAC880** 800/400  
**RBAC845** 800/450  
**RBAC850** 800/500  
**RBAC860** 800/600  
**RBAC940** 900/400  
**RBAC945** 900/450

H:720mm  
CODE  
**RBAC950** 900/500  
**RBAC960** 900/600  
**RBAC140** 1000/400  
**RBAC145** 1000/450  
**RBAC10** 1000/500  
**RBAC160** 1000/600  
**RBAC12** 1200/600

Inc. Corner Post & Blanking Panel

**HI-LINE CORNER BASE** **DRAWERLINE BASE** **DRAWERLINE SINK BASE** **CERAMIC SINK BASE** **DRAWERLINE CORNER BASE** **BUILT UNDER**

'L' Shaped

H:720mm  
CODE  
**BAC90** 900x900  
Bi-fold hinge system  
Flat pack

Single Top Drawer

H:720mm  
CODE  
**RBD30** 300  
**RBD40** 400  
**RBD45** 450  
**RBD50** 500  
**RBD60** 600  
**RBD80#** 800  
**RBD90#** 900  
**RBD10#** 1000  
**RBD12#** 1200  
# 2 x Doors

H:720mm  
CODE  
**RBD80/1** 800  
**RBD90/1** 900  
**RBD10/1** 1000

H:720mm  
CODE  
**RBDF50** 500  
**RBDF60** 600  
**RBDF80#** 800  
**RBDF90#** 900  
**RBDF10#** 1000  
**RBDD10\*#** 1000  
**RBDD12\*#** 1200  
\*One working drawer  
# 2 x Doors

H:720mm  
CODE  
**RBSU60** 600x460  
**RBSU8050** 800x500  
To suit a sink height of 260mm  
To suit a sink height of 220mm

H:720mm  
CODE  
**RBDC830** 800/300  
**RBDC80** 800/400  
**RBDC845** 800/450  
**RBDC850** 800/500  
**RBDC860** 800/600

H:720mm  
CODE  
**RBDC140** 1000/400  
**RBDC145** 1000/450  
**RBDC10** 1000/500  
**RBDC160** 1000/600  
**RBDC12** 1200/600

Inc. Corner Post & Blanking Panel

Oven

H:720mm  
CODE  
**RBUM60** 600  
175mm drawer & 110mm filler

Microwave

H:720mm  
CODE  
**RBUM60** 600  
175mm drawer & 110mm filler

**2 DRAWER BASE** **3 DRAWER BASE** **4 DRAWER BASE** **5 DRAWER BASE** **LOW WALL**

H:720mm  
CODE  
**RBD250** 500  
**RBD260** 600  
**RBD280** 800  
**RBD290** 900  
**RBD210** 1000  
2x355mm Drawers

H:720mm  
CODE  
**RBD350** 500  
**RBD360** 600  
**RBD380** 800  
**RBD390** 900  
**RBD310** 1000  
1x140mm, 2x283mm Drawers

H:720mm  
CODE  
**RBD450** 500  
**RBD460** 600  
**RBD480** 800  
**RBD490** 900  
**RBD410** 1000  
3x140mm, 1x283mm Drawers

H:720mm  
CODE  
**RBD530** 300  
**RBD540** 400  
**RBD545** 450  
**RBD550** 500  
**RBD560** 600  
**RBD580** 800  
**RBD590** 900  
**RBD510** 1000  
5x140mm Drawers

H:575mm  
CODE  
**RWU30-5** 300  
**RWU40-5** 400  
**RWU45-5** 450  
**RWU50-5** 500  
**RWU60-5** 600

H:575mm  
CODE  
**R2WU60-5\*#** 600  
**RWU80-5#** 800  
**RWU90-5#** 900  
**RWU10-5#** 1000  
\*No muntin [2 x 300 doors]  
# 2 x Doors

Add 'X' to the end of the code for 350mm deep

Diagonal Corner

H:575mm  
CODE  
**RCWD60-5** 600x600  
Add 'X' to the end of the code for 350mm deep [650x650]

Splayed

H:575mm  
CODE  
**RAWU360-5** 360  
Add 'X' to the end of the code for 350mm deep

**MEDIUM WALL**

H:720mm  
CODE  
**RWU30-7** 300  
**RWU35-7** 350  
**RWU40-7** 400  
**RWU45-7** 450  
**RWU50-7** 500  
**RWU60-7** 600

Diagonal Corner

H:720mm  
CODE  
**R2WU60-9\*#** 600  
**RWU70-9#** 700  
**RWU80-9#** 800  
**RWU90-9#** 900  
**RWU10-9#** 1000  
\*No muntin [2x300 doors]  
# 2 x Doors

'L' Shaped Corner

H:720mm  
CODE  
**RCWD60-7** 600x600  
Add 'X' to the end of the code for 350mm deep [650x650]

Conventional Corner

H:720mm  
CODE  
**RCWL60-7** 600x600  
Bi-fold hinge system  
Add 'X' to the end of the code for 350mm deep [650x650]

Splayed

H:720mm  
CODE  
**RWUC60-7** 600  
Inc. Corner Post  
Add 'X' to the end of the code for 350mm deep

Microwave Wall

H:720mm  
CODE  
**RAWU360-7** 360  
Add 'X' to the end of the code for 350mm deep

Bi-Fold

H:720mm  
CODE  
**RMWU60-7** 600  
283mm flap, 110mm filler; Mechanism inc.  
Add 'X' to the end of the code for 350mm deep

H:720mm  
CODE  
**RBFWU50-7** 500  
**RBFWU60-7** 600  
**RBFWU80-7** 800  
**RBFWU90-7** 900  
**RBFWU10-7** 1000  
Mechanism inc.  
Add 'X' to the end of the code for 350mm deep

**TALL WALL** **HORIZONTAL WALL**

H:900mm  
CODE  
**RWU30-9** 300  
**RWU40-9** 400  
**RWU45-9** 450  
**RWU50-9** 500  
**RWU60-9** 600

Diagonal Corner

D:300mm  
H:900mm  
CODE  
**R2WU60-9\*#** 600  
**RWU80-9#** 800  
**RWU90-9#** 900  
**RWU10-9#** 1000  
\*No muntin [2x300 doors]  
# 2 x Doors

Splayed

D:300mm  
H:900mm  
CODE  
**RCWD60-9** 600x600  
Add 'X' to the end of the code for 350mm deep [650x650]

Boiler Wall

D:300mm  
H:900mm  
CODE  
**RAWU360-9** 360  
Add 'X' to the end of the code for 350mm deep







H:290mm  
CODE  
**BWU6040-9** 600  
400mm Deep  
Flat pack

H:290mm  
CODE  
**RHWU5029** 500  
**RHWU6029** 600  
**RHWU8029** 800  
**RHWU9029** 900  
**RHWU1029** 1000

D:300mm  
CODE  
**RHWU5036** 500  
**RHWU6036** 600  
**RHWU8036** 800  
**RHWU9036** 900  
**RHWU1036** 1000



OPEN WALL

					
H:290mm CODE <b>RWOS50-2</b> 500 <b>RWOS60-2</b> 600 <b>RWOS80-2</b> 800 <b>RWOS90-2</b> 900 <b>RWOS10-2</b> 1000 MFC Carcase	D:300mm WIDTH <b>RWOS50-3</b> 500 <b>RWOS60-3</b> 600 <b>RWOS80-3</b> 800 <b>RWOS90-3</b> 900 <b>RWOS10-3</b> 1000 MFC Carcase	H:360mm CODE <b>RWOS30-5</b> 300 <b>RWOS40-5</b> 400 <b>RWOS45-5</b> 450 <b>RWOS50-5</b> 500 <b>RWOS60-5</b> 600 <b>RWOS80-5</b> 800 <b>RWOS90-5</b> 900 <b>RWOS10-5</b> 1000 MFC Carcase	D:300mm WIDTH <b>RWOS30-7</b> 300 <b>RWOS40-7</b> 400 <b>RWOS45-7</b> 450 <b>RWOS50-7</b> 500 <b>RWOS60-7</b> 600 <b>RWOS80-7</b> 800 <b>RWOS90-7</b> 900 <b>RWOS10-7</b> 1000 MFC Carcase	H:720mm CODE <b>RWOS30-9</b> 300 <b>RWOS40-9</b> 400 <b>RWOS45-9</b> 450 <b>RWOS50-9</b> 500 <b>RWOS60-9</b> 600 <b>RWOS80-9</b> 800 <b>RWOS90-9</b> 900 <b>RWOS10-9</b> 1000 MFC Carcase	D:300mm WIDTH <b>RDC1/50</b> 500 <b>RDC1/60</b> 600 MFC Carcase
If 350mm deep carcase is required adjust code, e.g RWOS1035-2		If 350mm deep carcase is required adjust code, e.g RWOS1035-5		If 350mm deep carcase is required adjust code, e.g RWOS1035-9	

MIDI UNITS

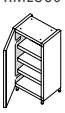
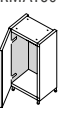
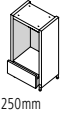
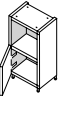
	
<b>RMLU60</b>	<b>RMA160</b>
	
<b>RMD060</b>	<b>RMOH560</b>
H:1250mm CODE <b>RMLU60</b> 600 <b>RMA160</b> 600 <b>RMD060</b> 600 <b>RMOH560</b> 600	WIDTH 500 600 600 600

LARDER

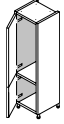
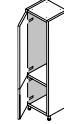
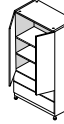
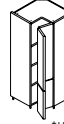
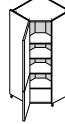
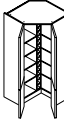
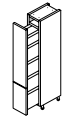
						
H:1970mm CODE <b>RTLU30</b> 300 <b>RTLU40</b> 400 <b>RTLU50</b> 500 <b>RTLU60</b> 600 <b>TLU80</b> 800 <b>TLU10</b> 1000	H:2150mm CODE <b>RETLU30</b> 300 <b>RETLU40</b> 400 <b>RETLU50</b> 500 <b>RETLU60</b> 600 <b>RETLU60/1*</b> 600 <b>ETLU80</b> 800 <b>ETLU10</b> 1000	Drawer Larder H:1970mm CODE <b>TDLU80</b> 800 <b>TDLU10</b> 1000	'L' Shaped H:1970mm CODE <b>TCLU98</b> 985x985 <b>ETCLU98*</b> 985x985 Bi-fold hinge system	Diagonal H:1970mm CODE <b>TDCLU1003</b> 1003x1003 <b>ETDCLU1003*</b> 1003x1003	Diagonal Walk-in Larder H:1970mm CODE <b>TDWIL1144</b> 1144x1144 <b>ETDWIL1144*</b> 1144x1144	H:1970mm CODE <b>RTISPOL30</b> 300 <b>RTKPOL30</b> 300 Standard Mechanism Inc. <b>RETISPOL30*</b> 300 <b>RETKPOL30*</b> 300 Kessebohmer Mechanism Inc.
*715mm bottom, 1425mm top door						

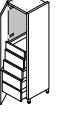
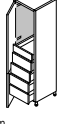

INNER DRAWER LARDER

	
H:1970mm CODE <b>RTLID30</b> 300 <b>RTLID40</b> 400 <b>RTLID50</b> 500 <b>RTLID60</b> 600	H:2150mm CODE <b>RETLID30</b> 300 <b>RETLID40</b> 400 <b>RETLID50</b> 500 <b>RETLID60</b> 600
1 x Standard, 4 x Deep drawers	

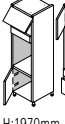
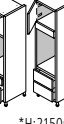
DOUBLE OVEN

	
H:1970mm CODE <b>RTOHD60</b> 600 <b>RTOHDD60*</b> 600	*H:2150mm CODE <b>RTOHS60</b> 600 <b>RTOHSD60*</b> 600

SINGLE OVEN

	
H:1970mm CODE <b>RTOHSC60</b> 600 <b>RETOHSC60*</b> 600	*H:2150mm CODE <b>RTOHSC60</b> 600 <b>RETOHSC60*</b> 600

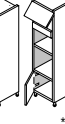

SINGLE OVEN + COMPACT

	
H:1970mm CODE <b>RTOHC60</b> 600 <b>RETOHC60*</b> 600	*H:2150mm CODE <b>RTOHC60</b> 600 <b>RETOHC60*</b> 600

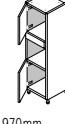
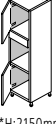
COMPACT

	
H:1970mm CODE <b>RTFF1/60</b> 600 <b>RTFF4/60*</b> 600 <b>RTFF1U/60#</b> 600 <b>RTFF4U/60#</b> 600	*H:2150mm CODE <b>RTFF1/60</b> 600 <b>RTFF2/60</b> 600 <b>RTFF3/60*</b> 600 <b>RTFF1U/60#</b> 600 <b>RTFF2U/60#</b> 600 <b>RTFF3U/60#</b> 600
*Doors undrilled # For door on door appliances	

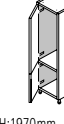
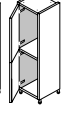
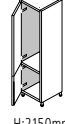

TALL FRIDGE/FREEZER

			
H:1970mm CODE <b>RETFF1/60</b> 600 <b>RETFF2/60</b> 600 <b>RETFF3/60*</b> 600 <b>RETFF1U/60#</b> 600 <b>RETFF2U/60#</b> 600 <b>RETFF3U/60#</b> 600	*H:2150mm CODE <b>RETFF1/60</b> 600 <b>RETFF2/60</b> 600 <b>RETFF3/60*</b> 600 <b>RETFF1U/60#</b> 600 <b>RETFF2U/60#</b> 600 <b>RETFF3U/60#</b> 600	*715mm bottom, 1425mm top door	

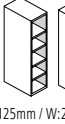
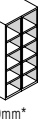

BOX WINE RACKS

	
W:125mm / W:250mm* CODE <b>RWR125-7</b> 720 <b>RWR250-7*</b> 720 <b>RWR125-9</b> 900 <b>RWR250-9*</b> 900 <b>WR125-1210</b> 1210 <b>WR125-1970</b> 1970 <b>WR250-1970*</b> 1970 MFC Carcase If using as base order LEGSET	HEIGHT <b>720</b> <b>720</b> <b>900</b> <b>900</b> <b>1210</b> <b>1970</b> <b>1970</b>

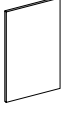

END SUPPORT PANELS

	
H:900mm CODE <b>ESP</b> 600 <b>900/700</b> 700 MFC Carcase	WIDTH <b>600</b> <b>700</b>

CARCASE MFC PANELS

	
CODE <b>1970/300</b> 2150/560 2350/660 720/300 900/2000 900/300 MFC Carcase <b>UG/**ET</b> 1000x22 *Un-Glued 1m Carcase Edging	WXH 300x1970 560x2150 660x2350 300x720 2000x900 300x900



CORNICE + PELMET

	
H:75mm CODE <b>CO/U5</b> 3000	Universal Pelmet/Pilaster H:35mm CODE <b>UPCM/U5</b> 3000x60 Can also be used as a 35mm wide end post - rebated for plant-on end panels

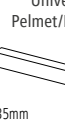
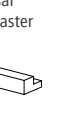

CORNICE MOULDING UPSTAND

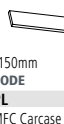
	
H:50mm CODE <b>COMU/U5</b> 3000	CODE <b>COMU/U5</b> 3000
Cornice Moulding Upstand Corner Block H:50mm CODE <b>RPCOMU/U5</b> 48x48 Use in conjunction with COMU/U5	



PLINTH

	
H:150mm CODE <b>PL</b> 2940 MFC Carcase <b>PL/U5</b> 3000 Door Finish	CODE <b>PST</b> 3000

CLEAR SEALING STRIP

	
H:150mm CODE <b>PL</b> 2940 MFC Carcase <b>PL/U5</b> 3000 Door Finish	CODE <b>PST</b> 3000

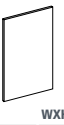
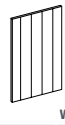

PLANT ON END PANELS

			
18mm Plain CODE <b>2430/650P/U5</b> 650x2430 <b>900/650P/U5</b> 650x900 <b>960/360P/U5</b> 360x960 Door Finish	18mm Beaded CODE <b>2430/650B/U5</b> 650x2430 <b>900/650B/U5</b> 650x900 <b>960/360B/U5</b> 360x960 Door Finish	18mm Plain Breakfast Bar Panel CODE <b>900/1200P/U5</b> 1200x900 <b>910/2430P/U5</b> 2430x910 Door Finish	18mm Beaded Breakfast Bar Panel CODE <b>900/1200B/U5</b> 1200x900 <b>910/2430B/U5</b> 2430x910 Door Finish





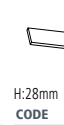

PILASTERS

H:900mm CODE <b>PIL/MOD900U5</b> 75 Door Finish

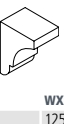
FURNITURE ACCESSORIES

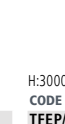
		
Corner Post (Spare) H:715mm CODE <b>CP/U5</b> 146 Flat Panel for on site conversion Door Finish	Flyover Shelf H:28mm CODE <b>FS/U5</b> 2400x325 Door Finish	Shelf Edge Moulding H:27mm CODE <b>EM/U5</b> 3000x47.5 Door Finish

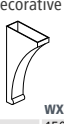
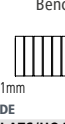
FURNITURE ACCESSORIES

			
H:166mm CODE <b>COR/U5</b> 125x90 Pair	H:180mm CODE <b>SB/U5</b> 35x140	H:3000mm CODE <b>TFEP/U5</b> 50x75	H:1150mm CODE <b>PSR/UOA</b> 379x100
			
H:850mm CODE <b>LCOR/U5</b> 150x448	H:21mm CODE <b>BSLATS/UOA</b> 82x460 Pack of 12	H:3000mm CODE <b>RP/U5</b> 50x70	H:75mm CODE <b>RPCO/U5</b> 92x92 Use in conjunction with CO/U5 & RP/U5

INTEGRATED DOORS

Undrilled CODE <b>INT4571</b> 446x715 <b>INT6071</b> 596x715

SPARE DOOR FITTINGS

Hinges [Hettich Soft Close] CODE <b>SCHINGE90</b> 90 degree [Pair] <b>SCHINGE170</b> 170 degree [Pair]

GENERAL ACCESSORIES

CODE <b>STPWN</b> Set of 2 Door Strapping Plates <b>LEGSET</b> Set of 4 Adjustable legs <b>SACC</b> Pk 50 14mm Self Adhesive Carcase Cover Caps

Note: Furniture codes beginning with the letter 'R' are assembled (rigid), by removing the 'R' the units are supplied unassembled (flat-pack).

SHAKER

PRICE GROUP 5, 7 + 8

# HALEBURY

PAINT TO ORDER

*Special sizes available*  
contact us for further information

Standard Colours Options [PG5]: Bone, Cotton, Fern, Putty, Riptide, Space, and Twilight.

PTO Colours Options [PG7]: Auburn, Black, Cashmere, Coal, Dusty Rose, Forest, Mink, Mist, Moss, Navy, Sea Salt, Smoke and Thyme.

Bespoke Colour Option [PG8]



## HI-LINE BASE

		<b>Pull-Out</b>	<b>Curved Door</b>	<b>Curved Return</b>	<b>Splayed</b>	<b>Shallow Base [300mm deep]</b>	<b>LOW BASE</b>	<b>HI-LINE CORNER BASE</b>
H:720mm CODE <b>RBA15</b> 150 <b>RBA26</b> 260 <b>RBA30</b> 300 <b>RBA35</b> 350 <b>RBA40</b> 400 <b>RBA45</b> 450 <b>RBA50</b> 500 <b>RBA60</b> 600	<b>WIDTH</b> <b>CODE</b> <b>WIDTH</b> <b>R2BA60*</b> 600 <b>RBA70#</b> 700 <b>RBA80#</b> 800 <b>RBA90#</b> 900 <b>RBA10#</b> 1000 <b>RBA12#</b> 1200 *No muntin [2x300 doors] # 2 x Doors	H:720mm CODE <b>RBISPO15</b> 150 Standard Mechanism inc. <b>RBKPO15</b> 150 Kesseböhmer Mechanism inc. <b>RBKTP015</b> 150 Kesseböhmer Mechanism & Towel rail inc.	H:720mm CODE <b>RCDBA30</b> 300x300	H:720mm CODE <b>RCRBA26</b> 260x300	H:720mm CODE <b>RABA360</b> 360	H:720mm CODE <b>RSBU30</b> 300 <b>RSBU35</b> 350 <b>RSBU40</b> 400 <b>RSBU45</b> 450 <b>RSBU50</b> 500 <b>RSBU60</b> 600 <b>RSBU70#</b> 700 <b>RSBU80#</b> 800 <b>RSBU90#</b> 900 <b>RSBU10#</b> 1000	H:575mm CODE <b>RLBU30</b> 300 <b>RLBU40</b> 400 <b>RLBU45</b> 450 <b>RLBU50</b> 500 <b>RLBU60</b> 600 <b>RLBU80#</b> 800 <b>RLBU90#</b> 900 <b>RLBU10#</b> 1000 <b>RLBU12#</b> 1200 # 2 x Doors	<b>'L' Shaped</b> H:720mm CODE <b>BAC90</b> 900x900 Bi-fold hinge system Flat pack  <b>Diagonal</b> H:720mm CODE <b>CDA90</b> 900x900 Flat pack

## HI-LINE CORNER BASE

	<b>DRAWERLINE BASE</b>	<b>Single Top Drawer</b>	<b>Open End Island Unit</b>	<b>DRAWERLINE SINK BASE</b>	<b>CERAMIC SINK BASE</b>	<b>DRAWERLINE CORNER BASE</b>
H:720mm CODE <b>RBAC830</b> 800/300 <b>RBAC80</b> 800/400 <b>RBAC845</b> 800/450 <b>RBAC850</b> 800/500 <b>RBAC860</b> 800/600 <b>RBAC940</b> 900/400 <b>RBAC945</b> 900/450 Inc. Corner Post & Blanking Panel	H:720mm CODE <b>RBAC950</b> 900/500 <b>RBAC960</b> 900/600 <b>RBAC140</b> 1000/400 <b>RBAC145</b> 1000/450 <b>RBAC10</b> 1000/500 <b>RBAC160</b> 1000/600 <b>RBAC12</b> 1200/600	H:720mm CODE <b>RBD30</b> 300 <b>RBD40</b> 400 <b>RBD45</b> 450 <b>RBD50</b> 500 <b>RBD60</b> 600 <b>RBD80#</b> 800 <b>RBD90#</b> 900 <b>RBD10#</b> 1000 <b>RBD12#</b> 1200 # 2 x Doors	H:870mm CODE <b>OEIU9/B**7</b> 910x500 <b>OEIU12/B**7</b> 1170x500 Includes drawer box and runners	H:720mm CODE <b>RBD50</b> 500 <b>RBD60</b> 600 <b>RBD80#</b> 800 <b>RBD90#</b> 900 <b>RBD10#</b> 1000 <b>RBD12#</b> 1200 # 2 x Doors	H:720mm CODE <b>RBSU60</b> 600x460 To suit a sink height of 260mm	H:720mm CODE <b>RBDC830</b> 800/300 <b>RBDC80</b> 800/400 <b>RBDC845</b> 800/450 <b>RBDC850</b> 800/500 <b>RBDC860</b> 800/600 Inc. Corner Post & Blanking Panel *One working drawer # 2 x Doors

## BUILT UNDER

<b>Oven</b>	<b>2 DRAWER BASE</b>	<b>3 DRAWER BASE</b>	<b>4 DRAWER BASE</b>	<b>5 DRAWER BASE</b>	<b>LOW WALL</b>	<b>Diagonal Corner</b>	<b>Splayed</b>
H:720mm CODE <b>RBU060</b> 600	H:720mm CODE <b>RBD250</b> 500 <b>RBD260</b> 600 <b>RBD280</b> 800 <b>RBD290</b> 900 <b>RBD210</b> 1000 2x355mm Drawers	H:720mm CODE <b>RBD350</b> 500 <b>RBD360</b> 600 <b>RBD380</b> 800 <b>RBD390</b> 900 <b>RBD310</b> 1000 1x140mm, 2x283mm Drawers	H:720mm CODE <b>RBD450</b> 500 <b>RBD460</b> 600 <b>RBD480</b> 800 <b>RBD490</b> 900 <b>RBD410</b> 1000 3x140mm, 1x283mm drawers	H:720mm CODE <b>RBD530</b> 300 <b>RBD540</b> 400 <b>RBD545</b> 450 <b>RBD550</b> 500 <b>RBD560</b> 600 <b>RBD580</b> 800 <b>RBD590</b> 900 <b>RBD510</b> 1000 5x140mm Drawers	H:575mm CODE <b>RWU30-5</b> 300 <b>RWU40-5</b> 400 <b>RWU45-5</b> 450 <b>RWU50-5</b> 500 <b>RWU60-5</b> 600 Add 'X' to the end of the code for 350mm deep	H:575mm CODE <b>RCWD60-5</b> 600x600 Add 'X' to the end of the code for 350mm deep [650x650]	H:575mm CODE <b>RAWU360-5</b> 360 Add 'X' to the end of the code for 350mm deep
H:720mm CODE <b>RBUM60</b> 600 175mm drawer & 110mm filler							

## MEDIUM WALL

	<b>Glazed Door</b>	<b>Diagonal Corner</b>	<b>'L' Shaped Corner</b>	<b>Conventional Corner</b>	<b>Splayed</b>	<b>Curved Door</b>	<b>Microwave Wall</b>
H:720mm CODE <b>RWU26-7</b> 260 <b>RWU30-7</b> 300 <b>RWU35-7</b> 350 <b>RWU40-7</b> 400 <b>RWU45-7</b> 450 <b>RWU50-7</b> 500 <b>RWU60-7#</b> 600	D:300mm CODE <b>R2WU60-7#</b> 600 <b>RWU70-7#</b> 700 <b>RWU80-7#</b> 800 <b>RWU90-7#</b> 900 <b>RWU10-7#</b> 1000 *No muntin [2x300 doors] # 2 x Doors	D:300mm CODE <b>RWG50-7</b> 500 <b>RWG10-7</b> 1000 <b>RWGR50-7*</b> 500 <b>RWGR50-7*</b> 1000 *Reeded glass Add 'X' to the end of the code for 350mm deep	D:300mm CODE <b>RCWL60-7</b> 600x600 <b>RCWL60-7</b> 600x600 Bi-fold hinge system Add 'X' to the end of the code for 350mm deep [650x650]	D:300mm CODE <b>RWUC60-7</b> 600 Inc. Corner Post Add 'X' to the end of the code for 350mm deep	D:300mm CODE <b>RAWU360-7</b> 360 Add 'X' to the end of the code for 350mm deep	D:300mm CODE <b>RCDWU30-7</b> 300x300	D:300mm CODE <b>RMWU60-7</b> 600 283mm flap, 110mm filler; Mechanism inc Add 'X' to the end of the code for 350mm deep

Add 'X' to the end of the code for 350mm deep

## MEDIUM WALL

<b>Bi-Fold</b>	<b>Glazed Door</b>	<b>Diagonal Corner</b>	<b>Splayed</b>	<b>Boiler Wall</b>	<b>HORIZONTAL WALL</b>
H:720mm CODE <b>RBFWU50-7</b> 500 <b>RBFWU60-7</b> 600 <b>RBFWU80-7</b> 800 <b>RBFWU90-7</b> 900 <b>RBFWU10-7</b> 1000 Mechanism inc. Add 'X' to the end of the code for 350mm deep	D:300mm H:900mm CODE <b>RWU30-9</b> 300 <b>RWU40-9</b> 400 <b>RWU45-9</b> 450 <b>RWU50-9</b> 500 <b>RWU60-9</b> 600	D:300mm H:900mm CODE <b>R2WU60-9#</b> 600 <b>RWU80-9#</b> 800 <b>RWU90-9#</b> 900 <b>RWU10-9#</b> 1000 *No muntin [2x300 doors] # 2 x Doors	D:300mm H:900mm CODE <b>RWG50-9</b> 500 <b>RWG10-9</b> 1000 <b>RWGR50-9*</b> 500 <b>RWGR10-9*</b> 1000 *Reeded glass Add 'X' to the end of the code for 350mm deep	D:300mm H:900mm CODE <b>RCWD60-9</b> 600x600 Add 'X' to the end of the code for 350mm deep [650x650]	D:300mm H:900mm CODE <b>RAWU360-9</b> 360 Add 'X' to the end of the code for 350mm deep

## HORIZONTAL WALL

H:290mm CODE <b>RHWU5029</b> 500 <b>RHWU6029</b> 600 <b>RHWU8029</b> 800 <b>RHWU9029</b> 900 <b>RHWU1029</b> 1000	H:360mm CODE <b>RHWU5036</b> 500 <b>RHWU6036</b> 600 <b>RHWU8036</b> 800 <b>RHWU1036</b> 900 <b>RHWU1036</b> 1000
---	---



GLAZED DRESSER



H:1210mm  
CODE  
**RDR2/50** 500  
**RDRR2/50\*** 500  
\*Reeded glass  
1 Drawer  
Add 'X' to the end of the code for 350mm deep

OPEN WALL



H:290mm  
CODE  
**RWOS50-2** 500  
**RWOS60-2** 600  
**RWOS80-2** 800  
**RWOS90-2** 900  
**RWOS10-2** 1000  
MFC Carcase  
If 350mm deep carcase is required adjust code, e.g RWOS1035-2



H:360mm  
CODE  
**RWOS50-3** 500  
**RWOS60-3** 600  
**RWOS80-3** 800  
**RWOS90-3** 900  
**RWOS10-3** 1000  
MFC Carcase  
If 350mm deep carcase is required adjust code, e.g RWOS1035-3



H:575mm  
CODE  
**RWOS30-5** 300  
**RWOS40-5** 400  
**RWOS45-5** 450  
**RWOS50-5** 500  
**RWOS60-5** 600  
**RWOS80-5** 800  
**RWOS90-5** 900  
**RWOS10-5** 1000  
MFC Carcase  
If 350mm deep carcase is required adjust code, e.g RWOS1035-5



H:720mm  
CODE  
**RWOS30-7** 300  
**RWOS40-7** 400  
**RWOS45-7** 450  
**RWOS50-7** 500  
**RWOS60-7** 600  
**RWOS80-7** 800  
**RWOS90-7** 900  
**RWOS10-7** 1000  
MFC Carcase  
If 350mm deep carcase is required adjust code, e.g RWOS1035-7



H:900mm  
CODE  
**RWOS30-9** 300  
**RWOS40-9** 400  
**RWOS45-9** 450  
**RWOS50-9** 500  
**RWOS60-9** 600  
**RWOS80-9** 800  
**RWOS90-9** 900  
**RWOS10-9** 1000  
**RDC1/50\*** 500  
**RDC1/60\*** 600  
MFC Carcase  
If 350mm deep carcase is required adjust code, e.g RWOS1035-9

MIDI UNITS



**RMLU60** **RMA160**  
H:1250mm  
CODE  
**RMLU60** 600  
**RMA160** 600  
**RMD060** **RMOHS60**  
H:1250mm  
CODE  
**RMD060** 600  
**RMOHS60** 600

LARDER



H:1970mm  
CODE  
**RTL30** 300  
**RTL40** 400  
**RTL50** 500  
**RTL60** 600  
**TLU80** 800  
**TLU10** 1000



H:2150mm  
CODE  
**RETL30** 300  
**RETL40** 400  
**RETL50** 500  
**RETL60** 600  
**ETLU80** 800  
**ETLU10** 1000  
**RETLU60/1\*** 600  
\*715mm bottom, 1425mm top door

Drawer Larder



H:1970mm  
CODE  
**TDLU80** 800  
**TDLU10** 1000  
2x355mm drawers

'L' Shaped



H:1970mm  
CODE  
**TCLU98** 985x985  
**ETCLU98\*** 985x985  
Bi-fold hinge system

Diagonal Walk-in Larder



H:1970mm  
CODE  
**TDWIL1144** 1144x1144  
**ETDWIL1144\*** 1144x1144

Diagonal



H:1970mm  
CODE  
**TDCLU1003** 1003x1003  
**ETDCLU1003\*** 1003x1003

PULL-OUT LARDER



H:1970mm  
CODE  
**RTISPOL30** 300  
**RTKPOL30** 300  
Standard Mechanism inc.  
**RETISPOL30\*** 300  
**RETKPOL30\*** 300  
Kesseböhmer Mechanism inc.

INNER DRAWER LARDER



H:1970mm  
CODE  
**RTLID30** 300  
**RTLID40** 400  
**RTLID50** 500  
**RTLID60** 600  
1 x Standard, 4 x Deep drawers



H:2150mm  
CODE  
**RETLID30** 300  
**RETLID40** 400  
**RETLID50** 500  
**RETLID60** 600

DOUBLE OVEN



H:1970mm  
CODE  
**RTOHD60** 600  
**RTOHDD60** 600  
**RETOHDD60\*** 600

SINGLE OVEN



H:1970mm  
CODE  
**RTOHS60** 600  
**RTOHSD60** 600  
**RETOHS60\*** 600

SINGLE OVEN + COMPACT



H:1970mm  
CODE  
**RTOHSC60** 600  
**RETOHSC60\*** 600

COMPACT



H:1970mm  
CODE  
**RTOHC60** 600  
**RETOHC60\*** 600

TALL FRIDGE/FREEZER



H:1970mm  
CODE  
**RTFF1/60** 600  
**RTFF4/60\*** 600  
\*Doors undrilled  
**RTFF1U/60#** 600  
**RTFF4U/60#** 600  
# For door on door appliances  
H:2150mm  
CODE  
**RETTFF1/60** 600  
**RETTFF2/60** 600  
**RETTFF3/60\*** 600  
**RETTFF1U/60#** 600  
**RETTFF2U/60#** 600  
**RETTFF3U/60#** 600  
\*715mm bottom, 1425mm top door

BOX WINE RACKS



W:125mm / W:250mm\*  
CODE  
**RWR125-7** 720  
**RWR250-7\*** 720  
**RWR125-9** 900  
**RWR250-9\*** 900  
**RWR125-1210** 1210  
**WR125-1970** 1970  
**WR250-1970\*** 1970  
If using as base order LEGSET MFC Carcase

END SUPPORT PANELS



H:900mm  
CODE  
**ESP** 600  
**900/700** 700  
MFC Carcase

CARCASE MFC PANELS



CODE  
**1970/300** 300x1970  
**2150/560** 560x2150  
**2350/660** 660x2350  
**720/300** 300x720  
**900/2000** 2000x900  
**900/300** 300x900  
MFC Carcase  
**UG/\*\*ET** 1000x22  
\*Un-Glued 1m Carcase Edging

CORNICE



Contemporary  
H:46mm  
CODE  
**COC/B** 3000  
Classic  
H:80mm  
CODE  
**COCL/B** 3000

COMBI



H:28mm  
CODE  
**CCCS/B** 370x370  
Use in conjunction with COC/B  
Curved Combi Section  
H:28mm  
CODE  
**CCMS/B** 322x322  
Use in conjunction with PCM/B

LIGHT BAFFLE



H:50mm  
CODE  
**LB/B** 3000  
Curved Light Pelmet Section  
H:50mm  
CODE  
**CLPS/B** 310x310  
Use in conjunction with LB/B

PLINTH



H:150mm  
CODE  
**PL** 2940  
Melamine [Carcase MFC]  
**PL/B\*** 3000  
Door finish  
**VF/B** 3000  
Veneered Filler  
Finished on both long edges - can be used as plinth  
\*Includes PST sealing strip

PLANT ON END PANELS



18mm Tongue & Grooved Reversible  
CODE  
**2440/390T/B** 390x2440  
**2440/650T/B** 650x2440  
**950/390T/B** 390x950  
**885/650T/B** 650x885  
T&G face has the superior finish Painted  
**NOT** Bone, Cotton, Fern, Putty, Riptide, Space & Twilight

PLANT ON END PANELS



18mm Plain Reversible  
CODE  
**2440/390P/B** 390x2440  
**2440/650P/B** 650x2440  
**950/390P/B** 390x950  
**885/650P/B** 650x885  
Plain face has the superior finish Painted  
**NOT** Bone, Cotton, Fern, Putty, Riptide, Space & Twilight

PLANT ON END PANELS



18mm Tongue & Grooved / Plain Reversible  
CODE  
**2440/390B** 390x2440  
**2440/650B** 650x2440  
**950/390B** 390x950  
**885/650B** 650x885  
Painted  
**ONLY** Bone, Cotton, Fern, Putty, Riptide, Space & Twilight

PLANT ON END PANELS



18mm Tongue & Grooved / Plain Reversible Breakfast Bar Panel  
CODE  
**900/2000T/B** 2000x900  
**900/2000P/B** 2000x900  
**900/2000B** 2000x900  
T&G face has the superior finish  
Plain face has the superior finish  
**NOT** Bone, Cotton, Fern, Putty, Riptide, Space & Twilight  
**ONLY** Bone, Cotton, Fern, Putty, Riptide, Space & Twilight

PILASTERS



Square  
H:910mm  
CODE  
**PIL/S910B** 50  
Curved  
H:910mm  
CODE  
**PIL/CUR910B** 910  
**PIL/CUR1350B** 1350  
**PIL/CUR2150B** 2150

FURNITURE ACCESSORIES

Corner Post [Spare]



H:715mm  
CODE  
**CP/B** 146  
Flat Panel for on site conversion

FURNITURE ACCESSORIES

Mantle Shelf



H:25mm  
CODE  
**MS/B** 2400x200  
Specify length required - can be made to size

FURNITURE ACCESSORIES

Decorative Corbel [Single]



H:219mm  
CODE  
**COR/B** 107x95

Decorative Shelf Support [Single]



H:170mm  
CODE  
**DSS/B** 60x140

FURNITURE ACCESSORIES

Door Hung Spice Rack



H:1050mm  
CODE  
**DHSR/BNO** 350x106

INTEGRATED DOORS

Undrilled



CODE  
**INT4571** 446x715  
**INT6071** 596x715

WINE CAB DOORS

Wine Cab Doors



CODE  
**WCD607** 715x596  
To suit Caple Wi6161  
**WCD60179** 1790x596  
To suit Caple WC1800 wine cabinet

SPARE DOOR FITTINGS

Hinges [Hettich Soft Close]

CODE  
**SCHINGE90** 90 degree [Pair]  
**SCHINGE170** 170 degree [Pair]

Stays [Blum Aventos]

CODE  
**BLSTAYHKS**  
HK S stay [Pair]  
\*[inc mounting brackets]

Note: Furniture codes beginning with the letter 'R' are assembled (rigid), by removing the 'R' the units are supplied unassembled (flat-pack).

SHAKER  
PRICE GROUP 3  
**HEWISH**

Special sizes available  
contact us for further information

Colours Options [PG 3]: Blue, Cashmere,  
Dust Grey, Grey, Hunter, Indigo and Mussel.



HI-LINE BASE      LOW BASE      HI-LINE CORNER BASE

**H:720mm CODE**

CODE	WIDTH
RBA15	150
RBA26	260
RBA30	300
RBA35	350
RBA40	400
RBA45	450
RBA50	500
RBA60	600

**Pull-Out**

**H:720mm CODE**

CODE	WIDTH
RBISPO15	150
RBKPO15	150
RBKTP015	150

Standard Mechanism inc.  
Kesseböhmer Mechanism inc.  
Kesseböhmer Mechanism & Towel rail inc.

**Shallow Base [300mm deep]**

**H:720mm CODE**

CODE	WIDTH
RSBU30	300
RSBU35	350
RSBU40	400
RSBU45	450
RSBU50	500
RSBU60	600
RSBU70#	700
RSBU80#	800
RSBU90#	900
RSBU10#	1000

# 2 x Doors

**Low Base**

**H:575mm CODE**

CODE	WIDTH
RLBU30	300
RLBU40	400
RLBU45	450
RLBU50	500
RLBU60	600
RLBU80#	800
RLBU90#	900
RLBU10#	1000
RLBU12#	1200

# 2 x Doors

**HI-LINE CORNER BASE**

**H:720mm CODE**

CODE	WIDTH	CODE	WIDTH
RBAC830	800/300	RBAC950	900/500
RBAC80	800/400	RBAC960	900/600
RBAC845	800/450	RBAC140	1000/400
RBAC850	800/500	RBAC145	1000/450
RBAC860	800/600	RBAC10	1000/500
RBAC940	900/400	RBAC160	1000/600
RBAC945	900/450	RBAC12	1200/600

Incl. Corner Post & Blanking Panel

HI-LINE CORNER BASE      DRAWERLINE BASE      DRAWERLINE SINK BASE      CERAMIC SINK BASE      DRAWERLINE CORNER BASE

**'L' Shaped**

**H:720mm CODE**

CODE	WIDTH
BAC90	900x900

Bi-fold hinge system  
Flatpack

**Diagonal**

**H:720mm CODE**

CODE	WIDTH
CDA90	900x900

Flatpack

**Single Top Drawer**

**H:720mm CODE**

CODE	WIDTH
RBD30	300
RBD40	400
RBD45	450
RBD50	500
RBD60	600
RBD80#	800
RBD90#	900
RBD10#	1000
RBD12#	1200

# 2 x Doors

**Drawerline Sink Base**

**H:720mm CODE**

CODE	WIDTH
RBD50	500
RBD60	600
RBD80#	800
RBD90#	900
RBD10#	1000
RBD12#	1200

\*One working drawer  
# 2 x Doors

**Ceramic Sink Base**

**H:460mm CODE**

CODE	WIDTH
RSU60	600

\*H:500mm  
To suit a sink height of 260mm  
To suit a sink height of 220mm

**Drawerline Corner Base**

**H:720mm CODE**

CODE	WIDTH	CODE	WIDTH
RBDC830	800/300	RBDC140	1000/400
RBDC80	800/400	RBDC145	1000/450
RBDC845	800/450	RBDC10	1000/500
RBDC850	800/500	RBDC160	1000/600
RBDC860	800/600	RBDC12	1200/600

Incl. Corner Post & Blanking Panel

BUILT UNDER      2 DRAWER BASE      3 DRAWER BASE      4 DRAWER BASE      5 DRAWER BASE      LOW WALL

**Oven**

**H:720mm CODE**

CODE	WIDTH
RBUM60	600

175mm Drawer & 110mm filler

**Microwave**

**H:720mm CODE**

CODE	WIDTH
RBUM60	600

175mm Drawer & 110mm filler

**2 DRAWER BASE**

**H:720mm CODE**

CODE	WIDTH
RBD250	500
RBD260	600
RBD280	800
RBD290	900
RBD210	1000

2x355mm Drawers

**3 DRAWER BASE**

**H:720mm CODE**

CODE	WIDTH
RBD350	500
RBD360	600
RBD380	800
RBD390	900
RBD310	1000

1x140mm, 2x283mm Drawers

**4 DRAWER BASE**

**H:720mm CODE**

CODE	WIDTH
RBD450	500
RBD460	600
RBD480	800
RBD490	900
RBD410	1000

3x140mm, 1x283mm Drawers

**5 DRAWER BASE**

**H:720mm CODE**

CODE	WIDTH
RBD530	300
RBD540	400
RBD545	450
RBD550	500
RBD560	600
RBD580	800
RBD590	900
RBD510	1000

5x140mm Drawers

**LOW WALL**

**H:575mm CODE**

CODE	WIDTH	CODE	WIDTH
RWU30-5	300	R2WU60-5#	600
RWU40-5	400	RWU80-5#	800
RWU45-5	450	RWU90-5#	900
RWU50-5	500	RWU10-5#	1000
RWU60-5	600		

\*No muntin [2x300 doors]  
# 2 x Doors  
Add 'X' to the end of the code for 350mm deep

LOW WALL      MEDIUM WALL

**Diagonal Corner**

**H:575mm CODE**

CODE	WIDTH
RCWD60-5	600x600

Add 'X' to the end of the code for 350mm deep [650x650]

**Splayed**

**H:575mm CODE**

CODE	WIDTH
RAWU360-5	360

Add 'X' to the end of the code for 350mm deep

**Medium Wall**

**H:720mm CODE**

CODE	WIDTH	CODE	WIDTH
RWU26-7	260	R2WU60-7#	600
RWU30-7	300	RWU70-7#	700
RWU35-7	350	RWU80-7#	800
RWU40-7	400	RWU90-7#	900
RWU45-7	450	RWU10-7#	1000
RWU50-7	500		
RWU60-7	600		

\*No muntin [2x300 doors]  
# 2 x Doors  
Add 'X' to the end of the code for 350mm deep

**Feature Glazed**

**H:720mm CODE**

CODE	WIDTH	CODE	WIDTH
RFEWU30-7	300	RFEWU70-7#	700
RFEWU35-7	350	RFEWU80-7#	800
RFEWU40-7	400	RFEWU90-7#	900
RFEWU45-7	450	RFEWU10-7#	1000
RFEWU50-7	500		
RFEWU60-7	600		

Clear acrylic glazing  
# 2 x Doors  
Add 'X' to the end of the code for 350mm deep

**Diagonal Corner**

**H:720mm CODE**

CODE	WIDTH
RCWD60-7	600x600

Add 'X' to the end of the code for 350mm deep [650x650]

**'L' Shaped Corner**

**H:720mm... CODE**

CODE	WIDTH
RCWL60-7	600x600

Bi-fold hinge system  
Add 'X' to the end of the code for 350mm deep [650x650]

MEDIUM WALL      TALL WALL

**Conventional Corner**

**H:720mm CODE**

CODE	WIDTH
RWUC60-7	600

Incl. Corner Post  
Add 'X' to the end of the code for 350mm deep

**Splayed**

**H:720mm CODE**

CODE	WIDTH
RAWU360-7	360

Add 'X' to the end of the code for 350mm deep

**Microwave Wall**

**H:720mm CODE**

CODE	WIDTH
RMWU60-7	600

283mm flap, 110mm filler; Mechanism inc.  
Add 'X' to the end of the code for 350mm deep

**Tall Wall**

**H:900mm CODE**

CODE	WIDTH	CODE	WIDTH
RWU30-9	300	R2WU60-9#	600
RWU40-9	400	RWU80-9#	800
RWU45-9	450	RWU90-9#	900
RWU50-9	500	RWU10-9#	1000
RWU60-9	600		

\*No muntin [2x300 doors]  
# 2 x Doors  
Add 'X' to the end of the code for 350mm deep

**Diagonal Corner**

**H:900mm CODE**

CODE	WIDTH
RCWD60-9	600x600

Add 'X' to the end of the code for 350mm deep [650x650]

**Splayed**

**H:900mm CODE**

CODE	WIDTH
RAWU360-9	360

Add 'X' to the end of the code for 350mm deep

**Boiler Wall**

**H:900mm CODE**

CODE	WIDTH
BWU6040-9	600

400mm Deep  
Flatpack

Note: Furniture codes beginning with the letter 'R' are assembled (rigid), by removing the 'R' the units are supplied unassembled (flat-pack).

**HORIZONTAL WALL**



H:290mm	WIDTH	H:360mm	WIDTH
<b>RHWU5029</b>	500	<b>RHWU5036</b>	500
<b>RHWU6029</b>	600	<b>RHWU6036</b>	600
<b>RHWU8029</b>	800	<b>RHWU8036</b>	800
<b>RHWU9029</b>	900	<b>RHWU9036</b>	900
<b>RHWU1029</b>	1000	<b>RHWU1036</b>	1000

Add 'X' to the end of the code for 350mm deep

**OPEN WALL**

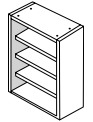

H:290mm	WIDTH	H:360mm	WIDTH
<b>RWOS50-2</b>	500	<b>RWOS50-3</b>	500
<b>RWOS60-2</b>	600	<b>RWOS60-3</b>	600
<b>RWOS80-2</b>	800	<b>RWOS80-3</b>	800
<b>RWOS90-2</b>	900	<b>RWOS90-3</b>	900
<b>RWOS10-2</b>	1000	<b>RWOS10-3</b>	1000

If 350mm deep carcass is required adjust code, e.g. RWOS1035-2

If 350mm deep carcass is required adjust code, e.g. RWOS1035-3

H:575mm	WIDTH	H:720mm	WIDTH
<b>RWOS30-5</b>	300	<b>RWOS30-7</b>	300
<b>RWOS40-5</b>	400	<b>RWOS40-7</b>	400
<b>RWOS45-5</b>	450	<b>RWOS45-7</b>	450
<b>RWOS50-5</b>	500	<b>RWOS50-7</b>	500
<b>RWOS60-5</b>	600	<b>RWOS60-7</b>	600
<b>RWOS80-5</b>	800	<b>RWOS80-7</b>	800
<b>RWOS90-5</b>	900	<b>RWOS90-7</b>	900
<b>RWOS10-5</b>	1000	<b>RWOS10-7</b>	1000

If 350mm deep carcass is required adjust code, e.g. RWOS1035-5

If 350mm deep carcass is required adjust code, e.g. RWOS1035-7

H:900mm	WIDTH	H:1210mm	WIDTH
<b>RWOS30-9</b>	300	<b>RDC1/50</b>	500
<b>RWOS40-9</b>	400	<b>RDC1/60</b>	600
<b>RWOS45-9</b>	450	MFC Carcass	
<b>RWOS50-9</b>	500	If 350mm deep carcass is required adjust code, e.g. RDC1/3550	
<b>RWOS60-9</b>	600		
<b>RWOS80-9</b>	800		
<b>RWOS90-9</b>	900		
<b>RWOS10-9</b>	1000		

If 350mm deep carcass is required adjust code, e.g. RWOS1035-9

**MIDI UNITS**

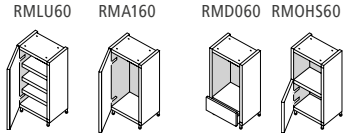

H:1250mm	WIDTH	H:1250mm	WIDTH
<b>RMLU60</b>	600	<b>RMD060</b>	600
<b>RMA160</b>	600	<b>RMOHS60</b>	600

**LARDER**

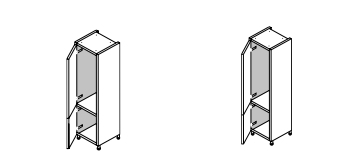

H:1970mm	WIDTH	H:2150mm	WIDTH
<b>RTLU30</b>	300	<b>RETLU30</b>	300
<b>RTLU40</b>	400	<b>RETLU40</b>	400
<b>RTLU50</b>	500	<b>RETLU50</b>	500
<b>RTLU60</b>	600	<b>RETLU60</b>	600
<b>TLU80</b>	800	<b>ETLU80</b>	800
<b>TLU10</b>	1000	<b>ETLU10</b>	1000

**Single Door**

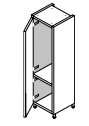

H:1970mm	WIDTH
<b>RTLUSD50</b>	500
<b>RTLUSD60</b>	600

**Drawer Larder**



H:1970mm	WIDTH
<b>TDLU80</b>	800
<b>TDLU10</b>	1000

**'L' Shaped**

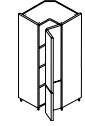

H:1970mm	*H:2150mm
<b>ETCLU98*</b>	985x985
<b>ETCLU98*</b>	985x985

**Diagonal Walk-in Larder**

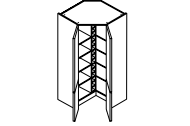

H:1970mm	*H:2150mm
<b>TDWIL1144</b>	1144x1144
<b>ETDWIL1144*</b>	1144x1144

**LARDER**

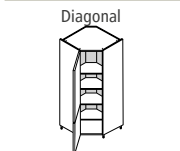

H:1970mm	*H:2150mm
<b>TDCLU1003</b>	1003x1003
<b>ETDCLU1003*</b>	1003x1003

**PULL-OUT LARDER**



H:1970mm	*H:2150mm
<b>RTISPOL30</b>	300
<b>RTKPOL30</b>	300
Standard Mechanism inc.	
<b>RETISPOL30*</b>	300
<b>RETKPOL30*</b>	300

**INNER DRAWER LARDER**

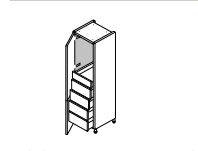

H:1970mm	WIDTH	H:2150mm	WIDTH
<b>RTLID30</b>	300	<b>RETLID30</b>	300
<b>RTLID40</b>	400	<b>RETLID40</b>	400
<b>RTLID50</b>	500	<b>RETLID50</b>	500
<b>RTLID60</b>	600	<b>RETLID60</b>	600

1 x Standard, 4 x Deep drawers

**DOUBLE OVEN**

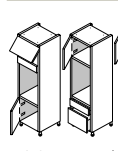

H:1970mm	*H:2150mm
<b>RTOHD60</b>	600
<b>RTOHDD60</b>	600
<b>RETOHDD60*</b>	600

**SINGLE OVEN**

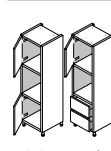

H:1970mm	*H:2150mm
<b>RTOHS60</b>	600
<b>RTOHSD60</b>	600
<b>RETOHSD60*</b>	600

**SINGLE OVEN + COMPACT**

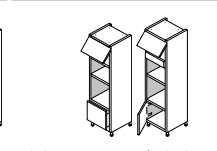

H:1970mm	*H:2150mm
<b>RTOHSC60</b>	600
<b>RETOHSC60*</b>	600

**COMPACT**



H:1970mm	*H:2150mm
<b>RTOHC60</b>	600
<b>RETOHC60*</b>	600

**TALL FRIDGE/FREEZER**



H:1970mm	WIDTH
<b>RTFF1/60</b>	600
<b>RTFF4/60*</b>	600
*Doors supplied undrilled	
<b>RTFF1U/60#</b>	600
<b>RTFF4U/60#</b>	600

#For door on door appliances

**BOX WINE RACKS**

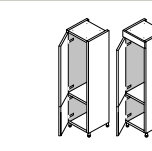

H:2150mm	WIDTH
<b>RETF1/60</b>	600
<b>RETF2/60</b>	600
<b>RETF1U/60#</b>	600
<b>RETF2U/60#</b>	600

#For door on door appliances

**END SUPPORT PANELS**

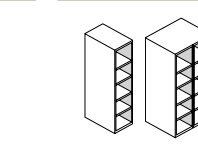

W:125mm / W:250mm*	HEIGHT
<b>RWR125-7</b>	720
<b>RWR250-7*</b>	720
<b>RWR125-9</b>	900
<b>RWR250-9*</b>	900
<b>RWR125-1210</b>	1210
<b>WR125-1970</b>	1970
<b>WR250-1970</b>	1970

MFC Carcass  
If using as base order LEGSET

**CARCASE MFC PANELS**

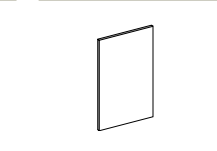

H:900mm	WIDTH
<b>ESP</b>	600
<b>900/700</b>	700

MFC Carcass

**CORNICE**

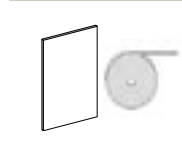

H:74mm	WIDTH
<b>CO/PF</b>	2700

Door Finish

**CLASSIC**



Door Finish

**UNIVERSAL PELMET/PILASTER**

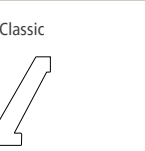

H:36mm  
UPCM/PF 2740x55  
Can also be used as a 36mm wide end post - rebated for plant-on end panels  
Door Finish

**PLINTH**



H:150mm	WIDTH
<b>PL</b>	2940
MFC Carcass	
<b>PL/PF</b>	2500

Door Finish

**Clear Sealing Strip**



H:150mm	WIDTH
<b>PST</b>	3000

Door Finish

**18mm Plain**

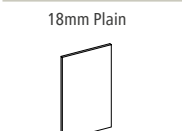

CODE	WXH
<b>2400/650/18PF</b>	650/2400
<b>900/650/18PF</b>	650/900
<b>950/350/18PF</b>	350/950

Door Finish

**Door Hung Spice Rack**



H:1050mm	WXD
<b>DHSR/BNO</b>	350x106

Door Finish

**Corner Post [Spare]**

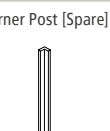

H:715mm	WIDTH
<b>CP/PF</b>	146

Flat Panel for on site conversion  
Door Finish

**UNDRIILLED**

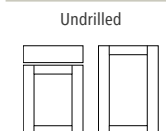

CODE	WXH
<b>INT4571</b>	446x715
<b>INT6071</b>	596x715

Door Finish

**SPARE DOOR FITTINGS**



CODE	DESCRIPTION
<b>SCHINGE90</b>	90 degree [Pair]
<b>SCHINGE170</b>	170 degree [Pair]

Stays [Blum Aventos]  
\*[inc mounting brackets]

**GENERAL ACCS.**

CODE	DESCRIPTION
<b>STPWN</b>	Set of 4 Door Strapping Plates
<b>LEGSET</b>	Adjustable legs
<b>SACC</b>	14mm Self Adhesive Cover Caps





SHAKER  
PRICE GROUP 2  
**KINGSLEY**

Special sizes available  
contact us for further information



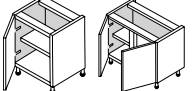

Colours Options [PG 2]: Anthracite, Black, Blush, Cashmere, Dust, Fern, Fiord, Grey, Hunter, Indigo, Mussel, Navy, Porcelain, Terracotta and White.

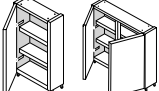
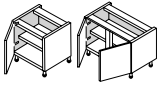

HI-LINE BASE LOW BASE







	Pull-Out	Curved Door	Splayed	Curved Return [300mm deep]	Shallow Base [300mm deep]	
						
H:720mm	H:720mm	H:720mm	H:720mm	H:720mm	H:720mm	H:575mm
<b>CODE</b> <b>WIDTH</b> <b>CODE</b> <b>WIDTH</b>	<b>CODE</b> <b>WIDTH</b>	<b>CODE</b> <b>WIDTH</b>	<b>CODE</b> <b>WIDTH</b>	<b>CODE</b> <b>WIDTH</b>	<b>CODE</b> <b>WIDTH</b>	<b>CODE</b> <b>WIDTH</b>
<b>RBA15</b> 150 <b>R2BA60*</b> 600	<b>RBISPO15</b> 150	<b>RCDBA30</b> 300x300	<b>RABA360</b> 360	<b>RCRBA26</b> 260	<b>RSBU30</b> 300	<b>RLBU30</b> 300
<b>RBA26</b> 260 <b>RBA70#</b> 700	Standard Mechanism inc.			<b>RSBU35</b> 350	<b>RSBU70#</b> 700	<b>RLBU40</b> 400
<b>RBA30</b> 300 <b>RBA80#</b> 800	<b>RBKPO15</b> 150			<b>RSBU40</b> 400	<b>RSBU80#</b> 800	<b>RLBU45</b> 450
<b>RBA35</b> 350 <b>RBA90#</b> 900	Kesseböhmer Mechanism inc.			<b>RSBU45</b> 450	<b>RSBU90#</b> 900	<b>RLBU50</b> 500
<b>RBA40</b> 400 <b>RBA10#</b> 1000	<b>RBKTP015</b> 150			<b>RSBU50</b> 500	# 2 x Doors	<b>RLBU60</b> 600
<b>RBA45</b> 450 <b>RBA12#</b> 1200	Kesseböhmer Mechanism & Towel rail inc.			<b>RSBU60</b> 600		<b>RLBU80#</b> 800
<b>RBA50</b> 500    *No muntin [2x300 doors]						<b>RLBU90#</b> 900
<b>RBA60</b> 600    # 2 x Doors						<b>RLBU10#</b> 1000
						<b>RLBU12#</b> 1200
						# 2 x Doors

HI-LINE CORNER BASE DRAWERLINE BASE DRAWERLINE SINK BASE CERAMIC SINK BASE

	'L' Shaped	Diagonal	Single Top Drawer		
					
H:720mm	H:720mm	H:720mm	H:720mm	H:720mm	H:460mm
<b>CODE</b> <b>WIDTH</b> <b>CODE</b> <b>WIDTH</b>	<b>CODE</b> <b>WIDTH</b>	<b>CODE</b> <b>WIDTH</b>	<b>CODE</b> <b>WIDTH</b>	<b>CODE</b> <b>WIDTH</b>	<b>CODE</b> <b>WIDTH</b>
<b>RBAC830</b> 800/300 <b>RBAC950</b> 900/500	<b>BAC90</b> 900x900	<b>CDA90</b> 900x900	<b>RBD30</b> 300	<b>RBD80/1</b> 800	<b>RBDF50</b> 500
<b>RBAC80</b> 800/400 <b>RBAC960</b> 900/600	Bi-fold hinge system		<b>RBD40</b> 400	<b>RBD90/1</b> 900	<b>RBDF60</b> 600
<b>RBAC845</b> 800/450 <b>RBAC140</b> 1000/400	Flatpack		<b>RBD45</b> 450	<b>RBD10/1</b> 1000	<b>RBDF80#</b> 800
<b>RBAC850</b> 800/500 <b>RBAC145</b> 1000/450			<b>RBD50</b> 500		<b>RBDF90#</b> 900
<b>RBAC860</b> 800/600 <b>RBAC10</b> 1000/500			<b>RBD60</b> 600		<b>RBDF10#</b> 1000
<b>RBAC940</b> 900/400 <b>RBAC160</b> 1000/600			<b>RBD80#</b> 800		<b>RBDD10*#</b> 1000
<b>RBAC945</b> 900/450 <b>RBAC12</b> 1200/600			<b>RBD90#</b> 900		<b>RBDD12*#</b> 1200
			<b>RBD10#</b> 1000		*One working drawer
			<b>RBD12#</b> 1200		# 2 x Doors
			# 2 x Doors		







Inc. Corner Post & Blanking Panel

DRAWERLINE CORNER BASE BUILT UNDER 2 DRAWER BASE 3 DRAWER BASE 4 DRAWER BASE 5 DRAWER BASE LOW WALL







	Oven						
							
H:720mm	H:720mm	H:720mm	H:720mm	H:720mm	H:720mm	H:575mm	
<b>CODE</b> <b>WIDTH</b> <b>CODE</b> <b>WIDTH</b>	<b>CODE</b> <b>WIDTH</b>	<b>CODE</b> <b>WIDTH</b>	<b>CODE</b> <b>WIDTH</b>	<b>CODE</b> <b>WIDTH</b>	<b>CODE</b> <b>WIDTH</b>	<b>CODE</b> <b>WIDTH</b>	<b>CODE</b> <b>WIDTH</b>
<b>RBDC830</b> 800/300 <b>RBDC140</b> 1000/400	<b>RBUM60</b> 600	<b>RBD250</b> 500	<b>RBD350</b> 500	<b>RBD450</b> 500	<b>RBD530</b> 300	<b>RWU30-5</b> 300	<b>R2WU60-5*#</b> 600
<b>RBDc80</b> 800/400 <b>RBDC145</b> 1000/450		<b>RBD260</b> 600	<b>RBD360</b> 600	<b>RBD460</b> 600	<b>RBD540</b> 400	<b>RWU40-5</b> 400	<b>RWU80-5#</b> 800
<b>RBDC845</b> 800/450 <b>RBDC10</b> 1000/500	Microwave	<b>RBD280</b> 800	<b>RBD380</b> 800	<b>RBD480</b> 800	<b>RBD545</b> 450	<b>RWU45-5</b> 450	<b>RWU90-5#</b> 900
<b>RBDC850</b> 800/500 <b>RBDC160</b> 1000/600		<b>RBD290</b> 900	<b>RBD390</b> 900	<b>RBD490</b> 900	<b>RBD550</b> 500	<b>RWU50-5</b> 500	<b>RWU10-5#</b> 1000
<b>RBDC860</b> 800/600 <b>RBDC12</b> 1200/600		<b>RBD210</b> 1000	<b>RBD310</b> 1000	<b>RBD410</b> 1000	<b>RBD560</b> 600	<b>RWU60-5</b> 600	*No muntin
		2x355mm Drawers	1x140mm, 2x283mm Drawers	3x140mm, 1x283mm Drawers	<b>RBD580</b> 800		# 2 x Doors
			<b>RBD350/175</b> 500	<b>RBD450/175</b> 500	<b>RBD590</b> 900		Add 'X' to the end of the code for 350mm deep
			<b>RBD360/175</b> 600	<b>RBD460/175</b> 600	<b>RBD510</b> 1000		
			2 x 175mm, 1x355mm Drawers	4x175mm Drawers	5x140mm Drawers		

Inc. Corner Post & Blanking Panel

LOW WALL MEDIUM WALL

	Diagonal Corner	Splayed		Diagonal Corner	'L' Shaped Corner	Conventional Corner	Splayed	Curved Door
								
H:575mm	H:575mm	H:720mm	H:720mm	H:720mm	H:720mm	H:720mm	H:720mm	H:720mm
<b>CODE</b> <b>WIDTH</b>	<b>CODE</b> <b>WIDTH</b>	<b>CODE</b> <b>WIDTH</b>	<b>CODE</b> <b>WIDTH</b>	<b>CODE</b> <b>WIDTH</b>	<b>CODE</b> <b>WIDTH</b>	<b>CODE</b> <b>WIDTH</b>	<b>CODE</b> <b>WIDTH</b>	<b>CODE</b> <b>WIDTH</b>
<b>RCWD60-5</b> 600x600	<b>RAWU360-5</b> 360	<b>RWU26-7</b> 260	<b>R2WU60-7*</b> 600	<b>RCWD60-7</b> 600x600	<b>RCWL60-7</b> 600x600	<b>RWUC60-7</b> 600	<b>RAWU360-7</b> 360	<b>RCDWU30</b> 300x300
Add 'X' to the end of the code for 350mm deep [650x650]	Add 'X' to the end of the code for 350mm deep	<b>RWU30-7</b> 300	<b>RWU70-7#</b> 700	Add 'X' to the end of the code for 350mm deep [650x650]	Bi-fold hinge system	Inc. Corner Post	Add 'X' to the end of the code for 350mm deep	Add 'X' to the end of the code for 350mm deep
		<b>RWU35-7</b> 350	<b>RWU80-7#</b> 800		Add 'X' to the end of the code for 350mm deep [650x650]	Add 'X' to the end of the code for 350mm deep		
		<b>RWU40-7</b> 400	<b>RWU90-7#</b> 900					
		<b>RWU45-7</b> 450	<b>RWU10-7#</b> 1000					
		<b>RWU50-7</b> 500	*No muntin [2x300 doors]					
		<b>RWU60-7</b> 600	# 2 x Doors					
			Add 'X' to the end of the code for 350mm deep					

MEDIUM WALL TALL WALL HORIZONTAL WALL

	Microwave Wall	Bi-Fold		Diagonal Corner	Splayed	Boiler Wall	
							
H:720mm	H:720mm	H:900mm	H:900mm	H:900mm	H:900mm	H:290mm	H:360mm
<b>CODE</b> <b>WIDTH</b>	<b>CODE</b> <b>WIDTH</b>	<b>CODE</b> <b>WIDTH</b>	<b>CODE</b> <b>WIDTH</b>	<b>CODE</b> <b>WIDTH</b>	<b>CODE</b> <b>WIDTH</b>	<b>CODE</b> <b>WIDTH</b>	<b>CODE</b> <b>WIDTH</b>
<b>RMWU60-7</b> 600	<b>RBFWU50-7</b> 500	<b>RWU30-9</b> 300	<b>R2WU60-9*</b> 600	<b>RCWD60-9</b> 600x600	<b>RAWU360-9</b> 360	<b>BWU6040-9</b> 600	<b>RHWU5029</b> 500
283mm flap, 110mm filler; Mechanism inc.		<b>RWU40-9</b> 400	<b>RWU80-9#</b> 800	Add 'X' to the end of the code for 350mm deep [650x650]	Add 'X' to the end of the code for 350mm deep	400mm Deep Flatpack	<b>RHWU6029</b> 600
Add 'X' to the end of the code for 350mm deep		<b>RWU45-9</b> 450	<b>RWU90-9#</b> 900				<b>RHWU8029</b> 800
		<b>RWU50-9</b> 500	<b>RWU10-9#</b> 1000				<b>RHWU9029</b> 900
		<b>RWU60-9</b> 600	*No muntin [2x300 doors]				<b>RHWU1029</b> 1000
			# 2 x Doors				<b>RHWU1036</b> 1000
			Add 'X' to the end of the code for 350mm deep				Add 'X' to the end of the code for 350mm deep



OPEN WALL

MIDI UNITS

LARDER

H:290mm CODE <b>RWOS50-2</b> 500 <b>RWOS60-2</b> 600 <b>RWOS80-2</b> 800 <b>RWOS90-2</b> 900 <b>RWOS10-2</b> 1000 MFC Carcase	H:360mm CODE <b>RWOS50-3</b> 500 <b>RWOS60-3</b> 600 <b>RWOS80-3</b> 800 <b>RWOS90-3</b> 900 <b>RWOS10-3</b> 1000 MFC Carcase	H:575mm CODE <b>RWOS30-5</b> 300 <b>RWOS40-5</b> 400 <b>RWOS45-5</b> 450 <b>RWOS50-5</b> 500 <b>RWOS60-5</b> 600 <b>RWOS80-5</b> 800 <b>RWOS90-5</b> 900 <b>RWOS10-5</b> 1000 MFC Carcase	H:720mm CODE <b>RWOS30-7</b> 300 <b>RWOS40-7</b> 400 <b>RWOS45-7</b> 450 <b>RWOS50-7</b> 500 <b>RWOS60-7</b> 600 <b>RWOS80-7</b> 800 <b>RWOS90-7</b> 900 <b>RWOS10-7</b> 1000 MFC Carcase	H:900mm CODE <b>RWOS30-9</b> 300 <b>RWOS40-9</b> 400 <b>RWOS45-9</b> 450 <b>RWOS50-9</b> 500 <b>RWOS60-9</b> 600 <b>RWOS80-9</b> 800 <b>RWOS90-9</b> 900 <b>RWOS10-9</b> 1000 MFC Carcase	H:1210mm CODE <b>RDC1/50</b> 500 <b>RDC1/60</b> 600 MFC Carcase	RMLU60 RMA160 RMD060 RMOHS60	H:1250mm CODE <b>RMLU60</b> 600 <b>RMA160</b> 600 <b>RMD060</b> 600 <b>RMOHS60</b> 600	H:1970mm CODE <b>RTL30</b> 300 <b>RTLU40</b> 400 <b>RTLU50</b> 500 <b>RTL60</b> 600 <b>TLU80</b> 800 <b>TLU10</b> 1000	
If 350mm deep carcase is required adjust code, e.g RWOS1035-2		If 350mm deep carcase is required adjust code, e.g RWOS1035-3		If 350mm deep carcase is required adjust code, e.g RWOS1035-5		If 350mm deep carcase is required adjust code, e.g RWOS1035-7		If 350mm deep carcase is required adjust code, e.g RWOS1035-9	

LARDER

PULL-OUT LARDER

INNER DRAWER LARDER

H:2150mm CODE <b>RELU30</b> 300 <b>RELU40</b> 400 <b>RELU50</b> 500 <b>RELU60</b> 600 <b>ETLU80</b> 800 <b>ETLU10</b> 1000	H:1970mm CODE <b>TDLU80</b> 800 <b>TDLU10</b> 1000 2x355mm Drawers	H:1970mm CODE <b>TCLU98</b> 985x985 <b>ETCLU98*</b> 985x985 Bi-fold hinge system	H:1970mm CODE <b>TDWIL1144</b> 1144x1144 <b>ETDWIL1144*</b> 1144x1144	*H:2150mm CODE <b>TDCLU1003</b> 1003x1003 <b>ETDCLU1003*</b> 1003x1003	H:1970mm CODE <b>RTISPOL30</b> 300 <b>RTKPOL30</b> 300 Standard Mechanism inc. <b>RETISPOL30*</b> 300 <b>RETKPOL30*</b> 300 Kesseböhmer Mechanism inc.	*H:2150mm CODE <b>RTLID30</b> 300 <b>RTLID40</b> 400 <b>RTLID50</b> 500 <b>RTLID60</b> 600 1 x Standard, 4 x Deep drawers	H:1970mm CODE <b>RTFF1U/60#</b> 600 <b>RTFF4U/60#</b> 600 *For door on door appliances

INNER DRAWER LARDER

DOUBLE OVEN

SINGLE OVEN

SINGLE OVEN + COMPACT

COMPACT

TALL FRIDGE/FREEZER

H:2150mm CODE <b>RETLID30</b> 300 <b>RETLID40</b> 400 <b>RETLID50</b> 500 <b>RETLID60</b> 600 1 x Standard, 4 x Deep drawers	H:1970mm CODE <b>RTOHD60</b> 600 <b>RTOHDD60</b> 600 <b>RETOHDD60*</b> 600	*H:2150mm CODE <b>RTOHS60</b> 600 <b>RTOHSD60</b> 600 <b>RETOHS60*</b> 600	H:1970mm CODE <b>RETOHSC60</b> 600 <b>RETOHSC60*</b> 600	*H:2150mm CODE <b>RTOHC60</b> 600 <b>RETOHC60*</b> 600	H:1970mm CODE <b>RTFF1/60</b> 600 <b>RTFF4/60*</b> 600 *Doors supplied undrilled	H:1970mm CODE <b>RTFF1U/60#</b> 600 <b>RTFF4U/60#</b> 600 *For door on door appliances

TALL FRIDGE/FREEZER

BOX WINE RACKS

END SUPPORT PANELS

CARCASE MFC PANELS

CORNICE

H:2150mm CODE <b>RETFF1/60</b> 600 <b>RETFF2/60</b> 600 <b>RETFF1U/60#</b> 600 <b>RETFF2U/60#</b> 600 *For door on door appliances	W:125mm / W:250mm* CODE <b>RWR125-7</b> 720 <b>RWR250-7*</b> 720 <b>RWR125-9</b> 900 <b>RWR250-9*</b> 900 <b>RWR125-1210</b> 1210 <b>WR125-1970</b> 1970 <b>WR250-1970*</b> 1970 MFC Carcase If using as base order LEGSET	H:900mm CODE <b>ESP</b> 600 <b>900/700</b> 700 MFC Carcase	H:900mm CODE <b>1970/300</b> 300x1970 <b>2150/560</b> 560x2150 <b>2350/660</b> 660x2350 <b>720/300</b> 300x720 <b>900/2000</b> 2000x900 <b>900/300</b> 300x900 MFC Carcase <b>UG**ET</b> 1000x22 *Un-Glued 1m Carcase Edging	H:62mm CODE <b>COH/TM</b> 3000 Door Finish	Classic H:62mm CODE <b>CHCS/TM</b> 318x318 Use in conjunction with COH/TM Door Finish	Curved Classic Cornice Section H:30mm CODE <b>PCM/TM</b> 3000 Door Finish	Combination H:30mm CODE <b>PCM/TM</b> 3000 Door Finish

CORNICE

PLINTH

PLANT ON END PANELS

FURNITURE ACCESSORIES

H:30mm CODE <b>CCMS/TM</b> 318x318 Use in conjunction with PCM/TM Door Finish	H:150mm CODE <b>PL</b> 2940 MFC Carcase <b>PL/TM</b> 3000 Door Finish	H:150mm CODE <b>CPLS/TM</b> 318x318 Door Finish Use in conjunction with PL/TM	H:150mm CODE <b>PST</b> 3000	H:150mm CODE <b>2350/650*/TM</b> 650x2350 <b>780/350*/TM</b> 350x780 <b>910/600*/TM</b> 600x910 <b>910/650*/TM</b> 650x910 <b>960/355*/TM</b> 355x960 Door Finish *P = plain / T = T&G	H:150mm CODE <b>900/2400*/TM</b> 2400x900 Door Finish *P = plain / T = T&G	H:715mm CODE <b>CP/TM*3</b> 146 Flat Panel for on site conversion Door Finish	H:3000mm CODE <b>RP/TM</b> 80x80 Door Finish

FURNITURE ACCESSORIES

INTEGRATED DOORS

SPARE DOOR FITTINGS

GENERAL ACCESSORIES

H:30mm CODE <b>RPCMC/TM</b> 80x80 Use in conjunction with PCM/TM & RP/TM Door Finish	H:62mm CODE <b>RPCOH/TM</b> 80x80 Use in conjunction with COH/TM & RP/TM Door Finish	H:1050mm CODE <b>DHSR/BNO</b> 350x106	CODE <b>INT4571</b> 446x715 <b>INT6071</b> 596x715	CODE <b>SCHINGE90</b> 90 degree [Pair] <b>SCHINGE170</b> 170 degree [Pair]	CODE <b>BLSTAYHKS</b> HK-S stay [Pair] *[inc mounting brackets]	CODE <b>STPWN</b> Set of 2 Door Strapping Plates <b>LEGSET</b> Set of 4 Adjustable legs <b>SACC</b> Pk 50 14mm Self Adhesive Cover Caps	

Note: Furniture codes beginning with the letter 'R' are assembled (rigid), by removing the 'R' the units are supplied unassembled (flat-pack).





SHAKER  
PRICE GROUP 5 + 6  
**LEIGH**  
PAINT TO ORDER

Special sizes available  
contact us for further information

Leigh Sanded [PG5]

Leigh Oak [PG6]

PTO Colours Options [PG6]: Alabaster, Antique Red, Black, Blush, Charcoal, Dark Sage, Dust Grey, Federal Blue, Fern, Gunmetal, Heritage Green, Hunter, Indigo, Ink, Light Grey, Midnight Blue, Palladian Blue, Pebble, Porcelain, Sage, Stone Grey, Storm and Woodland Grey.



HI-LINE BASE LOW BASE HI-LINE CORNER BASE HI-LINE CORNER BASE

**Pull-Out**

H:720mm CODE	WIDTH	CODE	WIDTH
RBA15	150	R2BA60*	600
RBA26	260	RBA70#	700
RBA30	300	RBA80#	800
RBA35	350	RBA90#	900
RBA40	400	RBA10#	1000
RBA45	450	RBA12#	1200
RBA50	500	*No muntin [2x300 doors]	
RBA60	600	# 2 x Doors	

**Curved Return**

H:720mm CODE	WIDTH
RCRBA26	260x300

**Shallow Base [300mm deep]**

H:720mm CODE	WIDTH
RSBU30	300
RSBU35	350
RSBU40	400
RSBU45	450
RSBU50	500
RSBU60	600
RSBU70#	700
RSBU80#	800
RSBU90#	900
RSBU10#	1000

**'L' Shaped**

H:720mm CODE	WIDTH
RLBU30	300
RLBU40	400
RLBU45	450
RLBU50	500
RLBU60	600
RLBU80#	800
RLBU90#	900
RLBU10#	1000
RLBU12#	1200

# 2 x Doors

**Diagonal**

H:720mm CODE	WIDTH
CDA90	900x900

Flat pack

DRAWERLINE BASE CERAMIC SINK BASE DRAWERLINE CORNER BASE BUILT UNDER

**Single Top Drawer**

H:720mm CODE	WIDTH	CODE	WIDTH
RBD30	300	RBD80#	800
RBD40	400	RBD90#	900
RBD45	450	RBD10#	1000
RBD50	500	RBD12#	1200
RBD60	600	# 2 x Doors	

**CERAMIC SINK BASE**

H:720mm CODE	WIDTH	CODE	WXH
RBDF50	500	RSBU60	600x460
RBDF60	600	To suit a sink height of 260mm	
RBDF80#	800	RSBU8050	800x500
RBDF90#	900	To suit a sink height of 220mm	
RBDF10#	1000		
RBDD10*#	1000		
RBDD12*#	1200		

\*One working drawer  
# 2 x Doors

**DRAWERLINE CORNER BASE**

H:720mm CODE	WIDTH	CODE	WIDTH
RBDC830	800/300	RBDC140	1000/400
RBDC80	800/400	RBDC145	1000/450
RBDC845	800/450	RBDC10	1000/500
RBDC850	800/500	RBDC160	1000/600
RBDC860	800/600	RBDC12	1200/600

Inc. Corner Post & Blanking Panel

**BUILT UNDER**

H:720mm CODE	WIDTH	H:720mm CODE	WIDTH
RBU060	600	RBUM60	600

175mm drawer & 110mm filler

2 DRAWER BASE 3 DRAWER BASE 4 DRAWER BASE 5 DRAWER BASE LOW WALL

**2 DRAWER BASE**

H:720mm CODE	WIDTH	CODE	WIDTH
RBD250	500	RBD350	500
RBD260	600	RBD360	600
RBD280	800	RBD380	800
RBD290	900	RBD390	900
RBD210	1000	RBD310	1000

2x355mm Drawers

**3 DRAWER BASE**

H:720mm CODE	WIDTH	CODE	WIDTH
RBD350/175	500	RBD360/175	600

2 x 175mm, 1x355mm Drawers

**4 DRAWER BASE**

H:720mm CODE	WIDTH	CODE	WIDTH
RBD450	500	RBD460	600
RBD480	800	RBD490	900
RBD410	1000	3x140mm, 1x283mm drawers	
RBD450/175	500	4x175mm Drawers	
RBD460/175	600	5x140mm Drawers	

**5 DRAWER BASE**

H:720mm CODE	WIDTH	CODE	WIDTH
RBD530	300	RBD540	400
RBD545	450	RBD550	500
RBD560	600	RBD580	800
RBD590	900	RBD510	1000

**LOW WALL**

H:575mm CODE	WIDTH	CODE	WIDTH
RWU30-5	300	R2WU60-5*#	600
RWU40-5	400	RWU80-5#	800
RWU45-5	450	RWU90-5#	900
RWU50-5	500	RWU10-5#	1000
RWU60-5	600	*No muntin [2 x 300 doors]	

# 2 x Doors  
Add 'X' to the end of the code for 350mm deep

MEDIUM WALL

**Bi-Fold**

H:720mm CODE	WIDTH	CODE	WIDTH
RWFU50-7	500	RWFU60-7	600
RWFU60-7	600	RWFU70-7#	700
RWFU80-7	800	RWFU90-7#	900
RWFU90-7	900	RWFU10-7#	1000
RWFU10-7	1000	*No muntin [2x300 doors]	

# 2 x Doors  
Add 'X' to the end of the code for 350mm deep

**Glazed Door**

H:720mm CODE	WIDTH	CODE	WIDTH
R2WU60-7*#	600	RWG50-7	500
RWU70-7#	700	RWG10-7	1000

Add 'X' to the end of the code for 350mm deep

**Diagonal Corner**

H:720mm CODE	WIDTH	CODE	WIDTH
RCWD60-7	600x600	Add 'X' to the end of the code for 350mm deep [650x650]	

**'L' Shaped Corner**

H:720mm CODE	WIDTH	CODE	WIDTH
RCWL60-7	600x600	Bi-fold hinge system Add 'X' to the end of the code for 350mm deep [650x650]	

**Conventional Corner**

H:720mm CODE	WIDTH	CODE	WIDTH
RWUC60-7	600	Inc. Corner Post Add 'X' to the end of the code for 350mm deep	

**Splayed**

H:720mm CODE	WIDTH	CODE	WIDTH
RAWU360-7	360	Add 'X' to the end of the code for 350mm deep	

**Curved Door**

H:720mm CODE	WIDTH	CODE	WIDTH
RCDWU30-7	300x300	Add 'X' to the end of the code for 350mm deep	

**Microwave Wall**

H:720mm CODE	WIDTH	CODE	WIDTH
RMWU60-7	600	283mm flap, 110mm filler; Mechanism inc Add 'X' to the end of the code for 350mm deep	

MEDIUM WALL TALL WALL

**Bi-Fold**

H:720mm CODE	WIDTH	CODE	WIDTH
RBFWU50-7	500	RWU30-9	300
RBFWU60-7	600	RWU40-9	400
RBFWU80-7	800	RWU45-9	450
RBFWU90-7	900	RWU50-9	500
RBFWU10-7	1000	RWU60-9	600

Mechanism inc.  
Add 'X' to the end of the code for 350mm deep

**Glazed Door**

H:900mm CODE	WIDTH	CODE	WIDTH
R2WU60-9*#	600	RWG50-9	500
RWU80-9#	800	RWG10-9	1000

Add 'X' to the end of the code for 350mm deep

**Diagonal Corner**

H:900mm CODE	WIDTH	CODE	WIDTH
RCWD60-9	600x600	Add 'X' to the end of the code for 350mm deep [650x650]	

**Splayed**

H:900mm CODE	WIDTH	CODE	WIDTH
RAWU360-9	360	Add 'X' to the end of the code for 350mm deep	

**Boiler Wall**

H:900mm CODE	WIDTH	CODE	WIDTH
BWU6040-9	600	400mm Deep Flat pack	

**HORIZONTAL WALL**

H:290mm CODE	WIDTH	CODE	WIDTH
RHWU5029	500	RHWU5036	500
RHWU6029	600	RHWU6036	600
RHWU8029	800	RHWU8036	800
RHWU9029	900	RHWU1036	900
RHWU1029	1000	RHWU1036	1000

Add 'X' to the end of the code for 350mm deep

**GLAZED DRESSER**



H:1210mm  
CODE WIDTH  
**RDR2/50** 500  
1 Drawer  
Add 'X' to the end of the code for 350mm deep

**OPEN WALL**



H:290mm  
CODE WIDTH  
**RWOS50-2** 500  
**RWOS60-2** 600  
**RWOS80-2** 800  
**RWOS90-2** 900  
**RWOS10-2** 1000  
MFC Carcase  

If 350mm deep carcase is required adjust code, e.g. RWOS1035-2



H:360mm  
CODE WIDTH  
**RWOS50-3** 500  
**RWOS60-3** 600  
**RWOS80-3** 800  
**RWOS90-3** 900  
**RWOS10-3** 1000  
MFC Carcase  

If 350mm deep carcase is required adjust code, e.g. RWOS1035-3



H:575mm  
CODE WIDTH  
**RWOS30-5** 300  
**RWOS40-5** 400  
**RWOS45-5** 450  
**RWOS50-5** 500  
**RWOS60-5** 600  
**RWOS80-5** 800  
**RWOS90-5** 900  
**RWOS10-5** 1000  
MFC Carcase  

If 350mm deep carcase is required adjust code, e.g. RWOS1035-5



H:720mm  
CODE WIDTH  
**RWOS30-7** 300  
**RWOS40-7** 400  
**RWOS45-7** 450  
**RWOS50-7** 500  
**RWOS60-7** 600  
**RWOS80-7** 800  
**RWOS90-7** 900  
**RWOS10-7** 1000  
MFC Carcase  

If 350mm deep carcase is required adjust code, e.g. RWOS1035-7



H:900mm  
CODE WIDTH  
**RWOS30-9** 300  
**RWOS40-9** 400  
**RWOS45-9** 450  
**RWOS50-9** 500  
**RWOS60-9** 600  
**RWOS80-9** 800  
**RWOS90-9** 900  
**RWOS10-9** 1000  
**RDC1/50** 500  
**RDC1/60** 600  
MFC Carcase  

If 350mm deep carcase is required adjust code, e.g. RWOS1035-9

**MIDI UNITS**

RMLU60 RMA160

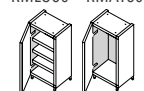

H:1250mm  
CODE WIDTH  
**RMLU60** 600  
**RMA160** 600

RMD060 RMOHS60

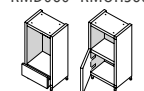

H:1250mm  
**RMD060** 600  
**RMOHS60** 600

**LARDER**



H:1970mm  
CODE WIDTH  
**RTL030** 300  
**RTLU40** 400  
**RTLU50** 500  
**RTL060** 600  
**TLU80** 800  
**TLU10** 1000

**LARDER**

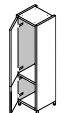

H:2150mm  
CODE WIDTH  
**RETLU30** 300  
**RETLU40** 400  
**RETLU50** 500  
**RETLU60** 600  
**ETLU80** 800  
**ETLU10** 1000  
**RETLU60/1\*** 600  
\*715mm bottom, 1425mm top door

**Drawer Larder**

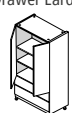

H:1970mm  
CODE WIDTH  
**TDLU80** 800  
**TDLU10** 1000  
2x355mm drawers

**'L' Shaped**

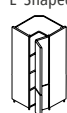

H:1970mm  
CODE WIDTH  
**TCLU98** 985x985  
**ETCLU98\*** 985x985  
Bi-fold hinge system

**Diagonal Walk-in Larder**

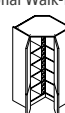

H:1970mm  
CODE WIDTH  
**TDWIL1144** 1144x1144  
**ETDWIL1144\*** 1144x1144

**Diagonal**

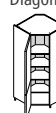

H:1970mm  
CODE WIDTH  
**TDCLU1003** 1003x1003  
**ETDCLU1003\*** 1003x1003

**PULL-OUT LARDER**

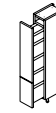

H:1970mm  
CODE WIDTH  
**RTISPOL30** 300  
**RTKPOL30** 300  
Standard Mechanism inc.  
**RETISPOL30\*** 300  
**RETKPOL30\*** 300  
Kessebohmer Mechanism inc.

**INNER DRAWER LARDER**

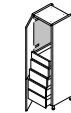

H:1970mm  
CODE WIDTH  
**RTLID30** 300  
**RTLID40** 400  
**RTLID50** 500  
**RTLID60** 600  
1 x Standard, 4 x Deep drawers

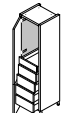

H:2150mm  
CODE WIDTH  
**RETLID30** 300  
**RETLID40** 400  
**RETLID50** 500  
**RETLID60** 600

**DOUBLE OVEN**

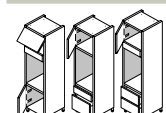

H:1970mm  
CODE WIDTH  
**RTOHD60** 600  
**RTOHHDD60** 600  
**RETOHDD60\*** 600

**SINGLE OVEN**

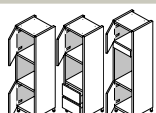

H:1970mm  
CODE WIDTH  
**RTOHS60** 600  
**RTOHSDD60** 600  
**RETOHS60\*** 600

**SINGLE OVEN + COMPACT**



H:1970mm  
CODE WIDTH  
**RTOHC60** 600  
**RETOHC60\*** 600

**COMPACT**

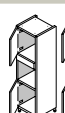

H:1970mm  
CODE WIDTH  
**RTOHC60** 600  
**RETOHC60\*** 600

**TALL FRIDGE/FREEZER**

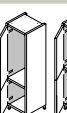

H:1970mm  
CODE WIDTH  
**RTFF1/60** 600  
**RTFF4/60\*** 600  
**RTFF1U/60#** 600  
**RTFF4U/60#** 600  
# For door on door appliances  
\*Doors undrilled

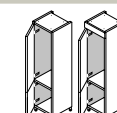

H:2150mm  
CODE WIDTH  
**RETFF1/60** 600  
**RETFF2/60** 600  
**RETFF3/60\*\*** 600  
**RETFF1U/60#** 600  
**RETFF2U/60#** 600  
**RETFF3U/60\*\*#** 600  
# For door on door appliances  
\*715mm bottom, 1425mm top door  
•Not Oak

**BOX WINE RACKS**

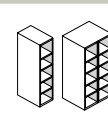

W:125mm / W:250mm\*  
CODE HEIGHT  
**RWR125-7** 720  
**RWR250-7\*** 720  
**RWR125-9** 900  
**RWR250-9\*** 900  
**RWR125-1210** 1210  
**WR125-1970** 1970  
**WR250-1970** 1970  
If using as base order LEGSET MFC Carcase

**END SUPPORT PANELS**



H:900mm  
CODE WIDTH  
**ESP** 600  
**900/700** 700  
MFC Carcase

**CARCASE MFC PANELS**

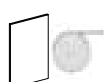

CODE WXH  
**1970/300** 300x1970  
**2150/560** 560x2150  
**2350/660** 660x2350  
**720/300** 300x720  
**900/2000** 2000x900  
**900/300** 300x900  
MFC Carcase  
**UG/\*\*ET** 1000x22  
\*Un-Glued 1m Carcase Edging

**WALL CANOPIES**



H:705mm  
CODE WIDTH  
**EX100/705U** 1000  
Can be reduced to 800mm

**CORNICE**



Traditional  
H:65mm  
CODE WIDTH  
**CO/U** 3000



Modern  
H:28mm  
CODE LENGTH  
**PCM/U** 3000



Curved Cornice Section  
H:65mm  
CODE WIDTH  
**CCOS/U** 430x430  
Use in conjunction with CO/U



Curved Combi Section  
H:28mm  
CODE WIDTH  
**CCMS/U** 430x430  
Use in conjunction with PCM/U

**LIGHT PELMET**



H:55mm  
CODE WIDTH  
**LB/U** 3000



Curved Light Pelmet Section  
H:55mm  
CODE WIDTH  
**CLPS/U** 430x430  
Use in conjunction with LB/U

**PLINTH**



H:150mm  
CODE WIDTH  
**PL** 2940  
Melamine [Carcase MFC]  
**PL/U** 3000  
Door finish



Curved Plinth Section  
H:150mm  
CODE WIDTH  
**CPLS/U** 506x366

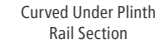

Curved Under Plinth Rail Section  
H:20mm  
CODE WIDTH  
**UPRS/U** 570x318

**PLINTH**

**Under Plinth Rail**



H:20mm  
CODE WIDTH  
**UPR/U** 3000

**Clear Sealing Strip**



CODE WIDTH  
**PST** 3000

**PLANT ON END PANELS**

**18mm Tongue & Grooved**



CODE WXH  
**2430/650T/18** 650x2430  
**900/650T/18** 650x900  
**960/360T/18** 360x960

**18mm Plain**



CODE WXH  
**2430/650P/18U** 650x2430  
**900/650P/18U** 650x900  
**960/360P/18U** 360x960

**18mm Tongue & Grooved Breakfast Bar Panel**



CODE WXH  
**900/1200T/18U** 1200x900  
**910/2450T/18U** 2450x910

**18mm Plain Breakfast Bar Panel**



CODE WXH  
**900/1200P/18U** 1200x900  
**910/2450P/18U** 2450x910

**PILASTERS**

**Modular**



W:75mm  
CODE HEIGHT  
**PIL/MOD2400** 2400  
**PIL/MOD900** 900  
**PILBEAD\*** 900

**FURNITURE ACCS.**

**Corner Post**



H:715mm  
CODE WIDTH  
**CP/UL** 146  
Flat Panel for on site conversion

**FURNITURE ACCESSORIES**



**Bench Slats**  
CODE  
**BSLATS/UOA** Pack of 12  
Oak

**Radius End Post**



H:3000mm  
CODE WIDTH  
**RP/U** 50

**Radius End Post Cap - Combi**



H:28mm  
CODE WXD  
**RPCMC/U** 52x52  
Use in conjunction with RP/U & CM/U

**Pantry Spice Rack**



H:1150mm  
CODE WXD  
**PSR/UOA** 379x100

**High Mantle Shelf**



H:170mm D:130mm  
CODE WIDTH  
**MSH/U** 1752

**Decorative Corbel [Pair]**



H:166mm  
CODE WXD  
**COR/U** 125x90

**Radius End Post Cap - Cornice**



H:65mm  
CODE WXD  
**RPCO/U** 92x92  
Use in conjunction with CO/U & RP/U

**INTEGRATED DOORS**

**Undrilled**



CODE WXH  
**INT4571** 446x715  
**INT6071** 596x715

**WINE CAB DOORS**



CODE WXH  
**WCD607** 715x596  
To suit Caple Wi6161

**SPARE DOOR FITTINGS**

**Hinges [Hettich Soft Close]**

CODE  
**SCHINGE90** 90 degree [Pair]  
**SCHINGE170** 170 degree [Pair]

**Stays [Blum Aventos]**

CODE  
**BLSTAYHKS**  
HK-S stay [Pair]  
\*[inc mounting brackets]

**GENERAL ACCS.**

CODE  
**STPPWN** Set of 2  
Door Strapping Plates  
**LEGSET** Set of 4  
Adjustable legs  
**SACC** Pk 50  
14mm Self Adhesive Cover Caps  
**TOUCH/U**  
Touch Up Paint 1ltr

Note: Furniture codes beginning with the letter 'R' are assembled (rigid), by removing the 'R' the units are supplied unassembled (flat-pack).

SHAKER  
PRICE GROUP 2  
**NALA**

Special sizes available  
contact us for further information

Colours Options [PG 2]: Anthracite, Black, Blush, Fern, Fjord, Grey, Hunter, Indigo, Mussel, Navy, Porcelain and Terracotta.



HI-LINE BASE LOW BASE

		Pull-Out		Curved Door		Splayed		Curved Return [300mm deep]		Shallow Base [300mm deep]					
H:720mm		H:720mm		H:720mm		H:720mm		H:720mm		H:720mm		H:575mm			
CODE	WIDTH	CODE	WIDTH	CODE	WIDTH	CODE	WIDTH	CODE	WIDTH	CODE	WIDTH	CODE	WIDTH		
RBA15	150	R2BA60*	600	RBISPO15	150	RCDBA30	300x300	RABA360	360	RCRBA26	260	RSBU30	300	RSBU70#	700
RBA26	260	RBA70#	700	Standard Mechanism inc.								RSBU35	350	RSBU80#	800
RBA30	300	RBA80#	800	RBKPO15	150							RSBU40	400	RSBU90#	900
RBA35	350	RBA90#	900	Kesseböhmer Mechanism inc.								RSBU45	450	RSBU10#	1000
RBA40	400	RBA10#	1000	RBKTP015	150	Kesseböhmer Mechanism & Towel rail inc.						RSBU50	500	# 2 x Doors	
RBA45	450	RBA12#	1200									RSBU60	600	RLBU30	300
RBA50	500	*No muntin [2x300 doors]												RLBU40	400
RBA60	600	# 2 x Doors												RLBU45	450
														RLBU50	500
														RLBU60	600
														RLBU80#	800
														RLBU90#	900
														RLBU10#	1000
														RLBU12#	1200
														# 2 x Doors	

HI-LINE CORNER BASE DRAWERLINE BASE DRAWERLINE SINK BASE CERAMIC SINK BASE

		L' Shaped		Diagonal		Single Top Drawer									
H:720mm		H:720mm		H:720mm		H:720mm		H:720mm		H:460mm					
CODE	WIDTH	CODE	WIDTH	CODE	WIDTH	CODE	WIDTH	CODE	WIDTH	CODE	WIDTH				
RBAC830	800/300	RBAC950	900/500	BAC90	900x900	CDA90	900x900	RBD30	300	RBD80/1	800	RBDF50	500	RSBU60	600
RBAC80	800/400	RBAC960	900/600	Bi-fold hinge system Flatpack				RBD40	400	RBD90/1	900	RBDF60	600	To suit a sink height of 260mm	
RBAC845	800/450	RBAC140	1000/400					RBD45	450	RBD10/1	1000	RBDF80#	800		
RBAC850	800/500	RBAC145	1000/450					RBD50	500			RBDF90#	900		
RBAC860	800/600	RBAC10	1000/500					RBD60	600			RBDF10#	1000		
RBAC940	900/400	RBAC160	1000/600					RBD80#	800			RBDD10*#	1000		
RBAC945	900/450	RBAC12	1200/600					RBD90#	900			RBDD12*#	1200		
								RBD10#	1000			*One working drawer # 2 x Doors			
								RBD12#	1200						
								# 2 x Doors							

Inc. Corner Post & Blanking Panel

DRAWERLINE CORNER BASE BUILT UNDER 2 DRAWER BASE 3 DRAWER BASE 4 DRAWER BASE 5 DRAWER BASE LOW WALL

		Oven													
H:720mm		H:720mm		H:720mm		H:720mm		H:720mm		H:720mm		H:575mm			
CODE	WIDTH	CODE	WIDTH	CODE	WIDTH	CODE	WIDTH	CODE	WIDTH	CODE	WIDTH	CODE	WIDTH		
RBDC830	800/300	RBDC140	1000/400	RBUC060	600	RBD250	500	RBD350	500	RBD450	500	RBD530	300	RWU30-5	300
RBDC80	800/400	RBDC145	1000/450	Microwave		RBD260	600	RBD360	600	RBD460	600	RBD540	400	RWU40-5	400
RBDC845	800/450	RBDC10	1000/500			RBD280	800	RBD380	800	RBD480	800	RBD545	450	RWU45-5	450
RBDC850	800/500	RBDC160	1000/600			RBD290	900	RBD390	900	RBD490	900	RBD550	500	RWU50-5	500
RBDC860	800/600	RBDC12	1200/600			RBD210	1000	RBD310	1000	RBD410	1000	RBD560	600	RWU60-5	600
						2x355mm Drawers		1x140mm, 2x283mm Drawers		3x140mm, 1x283mm Drawers		5x140mm Drawers		RWU10-5#	1000
								RBD350/175	500	RBD450/175	500			*No muntin # 2 x Doors	
								RBD360/175	600	RBD460/175	600			Add 'X' to the end of the code for 350mm deep	
								2 x 175mm, 1x355mm Drawers							

Inc. Corner Post & Blanking Panel

LOW WALL MEDIUM WALL

Diagonal Corner		Splayed				Glazed Door		Diagonal Corner		'L' Shaped Corner		Conventional Corner		Splayed			
H:575mm		H:575mm		H:720mm		H:720mm		H:720mm		H:720mm		H:720mm		H:720mm			
CODE	WIDTH	CODE	WIDTH	CODE	WIDTH	CODE	WIDTH	CODE	WIDTH	CODE	WIDTH	CODE	WIDTH	CODE	WIDTH		
RCWD60-5	600x600	RAWU360-5	360	RWU26-7	260	R2WU60-7*	600	RWG50-7	500	RCWD60-7	600x600	RCWL60-7	600x600	RWUC60-7	600	RAWU360-7	360
Add 'X' to the end of the code for 350mm deep [650x650]		Add 'X' to the end of the code for 350mm deep		RWU30-7	300	RWU70-7#	700	RWG10-7	1000	Add 'X' to the end of the code for 350mm deep [650x650]		Bi-fold hinge system Add 'X' to the end of the code for 350mm deep [650x650]		Inc. Corner Post Add 'X' to the end of the code for 350mm deep		Add 'X' to the end of the code for 350mm deep	
				RWU35-7	350	RWU80-7#	800	Add 'X' to the end of the code for 350mm deep									
				RWU40-7	400	RWU90-7#	900										
				RWU45-7	450	RWU10-7#	1000										
				RWU50-7	500	*No muntin [2x300 doors] # 2 x Doors											
				RWU60-7	600												

Add 'X' to the end of the code for 350mm deep

MEDIUM WALL TALL WALL

Curved Door		Microwave Wall		Bi-Fold				Glazed Door		Diagonal Corner		Splayed		Boiler Wall			
H:720mm		H:720mm		H:720mm		H:900mm		H:900mm		H:900mm		H:900mm		H:900mm			
CODE	WIDTH	CODE	WIDTH	CODE	WIDTH	CODE	WIDTH	CODE	WIDTH	CODE	WIDTH	CODE	WIDTH	CODE	WIDTH		
RCDWU30	300x300	RMWU60-7	600	RBFWU50-7	500	RWU30-9	300	R2WU60-9*	600	RWG50-9	500	RCWD60-9	600x600	RAWU360-9	360	BWU6040-9	600
		283mm flap, 110mm filler; Mechanism inc.		RWU40-9	400	RWU40-9	400	RWU80-9#	800	RWG10-9	1000	Add 'X' to the end of the code for 350mm deep [650x650]		Add 'X' to the end of the code for 350mm deep		400mm Deep Flatpack	
				RBFWU80-7	800	RWU45-9	450	RWU90-9#	900	Add 'X' to the end of the code for 350mm deep							
				RBFWU80-7	900	RWU50-9	500	RWU10-9#	1000								
				RBFWU10-7	1000	RWU60-9	600	*No muntin [2x300 doors] # 2 x Doors									

Add 'X' to the end of the code for 350mm deep

Note: Furniture codes beginning with the letter 'R' are assembled (rigid), by removing the 'R' the units are supplied unassembled (flat-pack).





SHAKER  
PRICE GROUP 4  
**NOVARA**

Colours Options [PG4]: Hunter, Light Grey, Porcelain and Storm.



HI-LINE BASE LOW BASE HI-LINE CORNER BASE 'L' Shaped

HI-LINE BASE	Pull-Out	LOW BASE	HI-LINE CORNER BASE	'L' Shaped
<p>H:720mm CODE WIDTH RBA15 150 RBA30 300 RBA35 350 RBA40 400 RBA45 450 RBA50 500 RBA60 600</p>	<p>H:720mm CODE WIDTH RBISPO15 150 Standard Mechanism inc. RBKPO15 150 Kesseböhmer Mechanism inc. RBKTP015 150 Kesseböhmer Mechanism &amp; Towel rail inc.</p>	<p>H:720mm CODE WIDTH RSBU30 300 RSBU35 350 RSBU40 400 RSBU45 450 RSBU50 500 RSBU60 600 RSBU70 700 RSBU80 800 RSBU90 900 RSBU10 1000</p>	<p>H:720mm CODE WIDTH RBU30 300 RLBU40 400 RLBU45 450 RLBU50 500 RLBU60 600 RLBU80# 800 RLBU90# 900 RLBU10# 1000 RLBU12# 1200 # 2 x Doors</p>	<p>H:720mm CODE WIDTH RBAC830 800/300 RBAC880 800/400 RBAC845 800/450 RBAC850 800/500 RBAC860 800/600 RBAC940 900/400 RBAC950 900/500 RBAC960 900/600 RBAC140 1000/400 RBAC145 1000/450 RBAC10 1000/500 RBAC160 1000/600 RBAC12 1200/600</p> <p>Inc. Corner Post &amp; Blanking Panel</p>
<p>H:720mm CODE WIDTH RBA15# 150 RBA30# 300 RBA35# 350 RBA40# 400 RBA45# 450 RBA50# 500 RBA60# 600</p>	<p>H:720mm CODE WIDTH RBA70# 700 RBA80# 800 RBA90# 900 RBA10# 1000 RBA12# 1200</p> <p>*No muntin [2x300 doors] # 2 x Doors</p>	<p>H:720mm CODE WIDTH RBU30# 300 RBU35# 350 RBU40# 400 RBU45# 450 RBU50# 500 RBU60# 600 RBU70# 700 RBU80# 800 RBU90# 900 RBU10# 1000</p>	<p>H:720mm CODE WIDTH RBU30# 300 RLBU40# 400 RLBU45# 450 RLBU50# 500 RLBU60# 600 RLBU80# 800 RLBU90# 900 RLBU10# 1000 RLBU12# 1200</p>	<p>H:720mm CODE WIDTH RBAC830# 800/300 RBAC880# 800/400 RBAC845# 800/450 RBAC850# 800/500 RBAC860# 800/600 RBAC940# 900/400 RBAC950# 900/500 RBAC960# 900/600 RBAC140# 1000/400 RBAC145# 1000/450 RBAC10# 1000/500 RBAC160# 1000/600 RBAC12# 1200/600</p>

HI-LINE CORNER BASE DRAWERLINE BASE DRAWERLINE SINK BASE CERAMIC SINK BASE DRAWERLINE CORNER BUILT UNDER

HI-LINE CORNER BASE	DRAWERLINE BASE	DRAWERLINE SINK BASE	CERAMIC SINK BASE	DRAWERLINE CORNER	BUILT UNDER
<p>Diagonal</p> <p>H:720mm CODE WIDTH CDA90 900x900 Flat pack</p>	<p>Single Top Drawer</p> <p>H:720mm CODE WIDTH RBD30 300 RBD40 400 RBD45 450 RBD50 500 RBD60 600 RBD80# 800 RBD90# 900 RBD10# 1000 RBD12# 1200</p> <p># 2 x Doors</p>	<p>H:720mm CODE WIDTH RBD50 500 RBD60 600 RBD80# 800 RBD90# 900 RBD10# 1000 RBD12# 1200</p> <p>*One working drawer # 2 x Doors</p>	<p>H:720mm CODE WXH RBSU60 600x460 To suit a sink height of 260mm RBSU80# 800x500 To suit a sink height of 220mm</p>	<p>H:720mm CODE WIDTH RBD830 800/300 RBD840 800/400 RBD845 800/450 RBD850 800/500 RBD860 800/600 RBD140 1000/400 RBD145 1000/450 RBD10 1000/500 RBD160 1000/600 RBD12 1200/600</p> <p>Inc. Corner Post &amp; Blanking Panel</p>	<p>Oven</p> <p>H:720mm CODE WIDTH RBU060 600</p> <p>Microwave</p> <p>H:720mm CODE WIDTH RBM60 600 175mm drawer &amp; 110mm filler</p>

2 DRAWER BASE 3 DRAWER BASE 4 DRAWER BASE 5 DRAWER BASE LOW WALL

2 DRAWER BASE	3 DRAWER BASE	4 DRAWER BASE	5 DRAWER BASE	LOW WALL
<p>H:720mm CODE WIDTH RBD250 500 RBD260 600 RBD280 800 RBD290 900 RBD210 1000</p> <p>2x355mm Drawers</p>	<p>H:720mm CODE WIDTH RBD350 500 RBD360 600 RBD380 800 RBD390 900 RBD310 1000</p> <p>1x140mm, 2x283mm Drawers</p>	<p>H:720mm CODE WIDTH RBD450 500 RBD460 600 RBD480 800 RBD490 900 RBD410 1000</p> <p>3x140mm, 1x283mm Drawers</p>	<p>H:720mm CODE WIDTH RBD530 300 RBD540 400 RBD545 450 RBD550 500 RBD560 600 RBD580 800 RBD590 900 RBD510 1000</p> <p>5x140mm Drawers</p>	<p>Diagonal Corner</p> <p>H:720mm CODE WIDTH RWU30-5 300 RWU40-5 400 RWU45-5 450 RWU50-5 500 RWU60-5 600</p> <p>Add 'X' to the end of the code for 350mm deep</p> <p>'L' Shaped Corner</p> <p>H:720mm CODE WIDTH R2WU60-5*# 600 RWU70-5# 800 RWU80-5# 800 RWU90-5# 900 RWU10-5# 1000</p> <p>*No muntin [2 x 300 doors] # 2 x Doors</p>

LOW WALL MEDIUM WALL

LOW WALL	MEDIUM WALL
<p>H:720mm CODE WIDTH RWU30-7 300 RWU35-7 350 RWU40-7 400 RWU45-7 450 RWU50-7 500 RWU60-7 600</p>	<p>Glazed Door</p> <p>H:720mm CODE WIDTH R2WU60-7*# 600 RWU70-7# 700 RWU80-7# 800 RWU90-7# 900 RWU10-7# 1000</p> <p>*No muntin [2x300 doors] # 2 x Doors</p> <p>Diagonal Corner</p> <p>H:720mm CODE WIDTH RCWD60-7 600x600</p> <p>Add 'X' to the end of the code for 350mm deep [650x650]</p> <p>'L' Shaped Corner</p> <p>H:720mm CODE WIDTH RCWL60-7 600x600</p> <p>Bi-fold hinge system Add 'X' to the end of the code for 350mm deep [650x650]</p> <p>Conventional Corner</p> <p>H:720mm CODE WIDTH RWUC60-7 600</p> <p>Inc. Corner Post Add 'X' to the end of the code for 350mm deep</p> <p>Splayed</p> <p>H:720mm CODE WIDTH RAWU360-7 360</p> <p>Add 'X' to the end of the code for 350mm deep</p> <p>Microwave Wall</p> <p>H:720mm CODE WIDTH RMWU60-7 600</p> <p>283mm flap, 110mm filler, Mechanism inc. Add 'X' to the end of the code for 350mm deep</p>

MEDIUM WALL TALL WALL

MEDIUM WALL	TALL WALL
<p>Bi-Fold</p> <p>H:720mm CODE WIDTH RBFWU50-7 500 RBFWU60-7 600 RBFWU80-7 800 RBFWU90-7 900 RBFWU10-7 1000</p> <p>Mechanism inc. Add 'X' to the end of the code for 350mm deep</p>	<p>Glazed Door</p> <p>H:900mm CODE WIDTH RWU30-9 300 RWU40-9 400 RWU45-9 450 RWU50-9 500 RWU60-9 600</p> <p>Add 'X' to the end of the code for 350mm deep</p> <p>Cross Rail</p> <p>H:900mm CODE WIDTH RCRWU30-9X 300 RCRWU40-9X 400 RCRWU45-9X 450 RCRWU50-9X 500 RCRWU60-9X 600</p> <p>Add 'X' to the end of the code for 350mm deep</p> <p>Diagonal Corner</p> <p>H:900mm CODE WIDTH RCWD60-9 600x600</p> <p>Add 'X' to the end of the code for 350mm deep [650x650]</p> <p>Splayed</p> <p>H:900mm CODE WIDTH RAWU360-9 360</p> <p>Add 'X' to the end of the code for 350mm deep</p>



TALL WALL HORIZONTAL WALL OPEN WALL

**Boiler Wall**

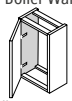

H:290mm  
H:900mm  
CODE **BWU6040-9**  
400mm Deep  
Flat pack

H:290mm	*H:360mm	D:300mm	H:290mm	D:300mm	H:360mm	D:300mm	H:575mm	D:300mm	H:720mm	D:300mm	H:900mm	D:300mm
CODE	CODE	WIDTH	CODE	WIDTH	CODE	WIDTH	CODE	WIDTH	CODE	WIDTH	CODE	WIDTH
<b>RHWU5029</b>	<b>RHWU6029</b>	500	<b>RHWU5029</b>	500	<b>RWOS50-2</b>	500	<b>RWOS50-3</b>	500	<b>RWOS30-5</b>	300	<b>RWOS30-7</b>	300
<b>RHWU8029</b>	<b>RHWU9029</b>	600	<b>RWOS60-2</b>	600	<b>RWOS60-3</b>	600	<b>RWOS40-5</b>	400	<b>RWOS40-7</b>	400	<b>RWOS40-9</b>	400
<b>RHWU1029</b>	<b>RHWU1029</b>	800	<b>RWOS80-2</b>	800	<b>RWOS80-3</b>	800	<b>RWOS45-5</b>	450	<b>RWOS45-7</b>	450	<b>RWOS45-9</b>	450
<b>RHWU1029</b>	<b>RHWU1029</b>	900	<b>RWOS90-2</b>	900	<b>RWOS90-3</b>	900	<b>RWOS50-5</b>	500	<b>RWOS50-7</b>	500	<b>RWOS50-9</b>	500
<b>RHWU1029</b>	<b>RHWU1029</b>	1000	<b>RWOS10-2</b>	1000	<b>RWOS10-3</b>	1000	<b>RWOS60-5</b>	600	<b>RWOS60-7</b>	600	<b>RWOS60-9</b>	600
<b>RHWU5036*</b>	<b>RHWU6036*</b>	500	MFC Carcase		MFC Carcase		<b>RWOS80-5</b>	800	<b>RWOS80-7</b>	800	<b>RWOS80-9</b>	800
<b>RHWU6036*</b>	<b>RHWU8036*</b>	600	If 350mm deep carcass is required adjust code, e.g. RWOS1035-2		If 350mm deep carcass is required adjust code, e.g. RWOS1035-3		<b>RWOS90-5</b>	900	<b>RWOS90-7</b>	900	<b>RWOS90-9</b>	900
<b>RHWU8036*</b>	<b>RHWU9036*</b>	800					<b>RWOS10-5</b>	1000	<b>RWOS10-7</b>	1000	<b>RWOS10-9</b>	1000
<b>RHWU9036*</b>	<b>RHWU1036*</b>	900					MFC Carcase		MFC Carcase		MFC Carcase	
<b>RHWU1036*</b>		1000					If 350mm deep carcass is required adjust code, e.g. RWOS1035-5		If 350mm deep carcass is required adjust code, e.g. RWOS1035-7		If 350mm deep carcass is required adjust code, e.g. RWOS1035-9	

Add 'X' to the end of the code for 350mm deep

OPEN WALL MIDI UNITS LARDER

**Drawer Larder**

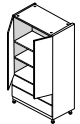

H:1970mm  
CODE **TDLU80**  
2x355mm drawers

**'L' Shaped**

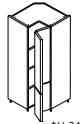

H:1970mm  
CODE **TCLU98**  
Bi-fold hinge system

**Diagonal**

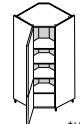

H:1970mm  
CODE **TDCLU1003**

**Diagonal Walk-in Larder**

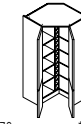

H:1970mm  
CODE **TDWIL1144**

H:1210mm	H:1970mm	H:2150mm	H:1970mm	H:1970mm	H:1970mm	H:1970mm	H:1970mm	H:1970mm	H:1970mm
CODE	CODE	CODE	CODE	CODE	CODE	CODE	CODE	CODE	CODE
<b>RDC1/50</b>	<b>RMLU60</b>	<b>RTLU30</b>	<b>RETLU30</b>	<b>TDLU80</b>	<b>TCLU98</b>	<b>TDCLU1003</b>	<b>TDWIL1144</b>	<b>RDC1/60</b>	<b>RMA160</b>
MFC Carcase									

PULL-OUT LARDER INNER DRAWER LARDER DOUBLE OVEN SINGLE OVEN SINGLE OVEN + COMPACT COMPACT TALL FRIDGE/FREEZER

**PULL-OUT LARDER**

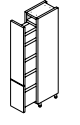

H:1970mm  
CODE **RTSPOL30**

**INNER DRAWER LARDER**

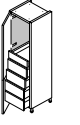

H:1970mm  
CODE **RTLID30**

**DOUBLE OVEN**

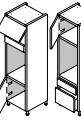

H:1970mm  
CODE **RTOHD60**

**SINGLE OVEN**

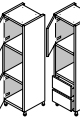

H:1970mm  
CODE **RTOHS60**

**SINGLE OVEN + COMPACT**

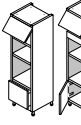

H:1970mm  
CODE **RETOHSC60\***

**COMPACT**



H:1970mm  
CODE **RETOHC60\***

**TALL FRIDGE/FREEZER**

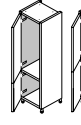

H:1970mm  
CODE **RTFF1/60**

H:1970mm	H:1970mm	H:1970mm	H:1970mm	H:1970mm	H:1970mm	H:1970mm	H:1970mm	H:1970mm	H:1970mm
CODE	CODE	CODE	CODE	CODE	CODE	CODE	CODE	CODE	CODE
<b>RTSPOL30</b>	<b>RTLID30</b>	<b>RTOHD60</b>	<b>RTOHS60</b>	<b>RETOHSC60*</b>	<b>RETOHC60*</b>	<b>RTFF1/60</b>	<b>RTKPOL30</b>	<b>RTLID40</b>	<b>RTFF4U/60*</b>
Standard Mechanism inc.						*Doors undrilled			

TALL FRIDGE/FREEZER BOX WINE RACKS END SUPPORT PANELS CARCASE MFC PANELS CORNICE + PELMET

**TALL FRIDGE/FREEZER**

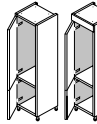

H:2150mm  
CODE **RETFF1/60**

**BOX WINE RACKS**

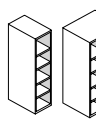

W:125mm / W:250mm\*  
CODE **RWR125-7**

**END SUPPORT PANELS**

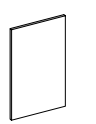

H:900mm  
CODE **ESP**

**CARCASE MFC PANELS**

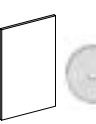

H:1970mm  
CODE **1970/300**

**CORNICE + PELMET**



H:75mm  
CODE **CO/U4**

**PLINTH**



H:150mm  
CODE **PL/U4**

H:2150mm	W:125mm / W:250mm*	H:900mm	H:1970mm	H:75mm	H:35mm	H:150mm
CODE	CODE	CODE	CODE	CODE	CODE	CODE
<b>RETFF1/60</b>	<b>RWR125-7</b>	<b>ESP</b>	<b>1970/300</b>	<b>CO/U4</b>	<b>UPCM/U4</b>	<b>PL/U4</b>

PLANT ON END PANELS PILASTERS FURNITURE ACCESSORIES INTEGRATED DOORS SPARE DOOR FITTINGS GENERAL ACCS.

**PLANT ON END PANELS**

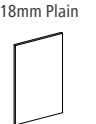

18mm Plain  
CODE **2430/650P/18U4**

**PILASTERS**



18mm Beaded  
CODE **2430/650B/18U4**

**FURNITURE ACCESSORIES**

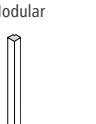

Modular  
CODE **PIL/MOD900U4**

**INTEGRATED DOORS**

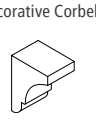

Undrilled  
CODE **INT4571**

**SPARE DOOR FITTINGS**



Hinges [Hettich Soft Close]  
CODE **SCHINGE90**

**GENERAL ACCS.**

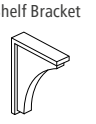

Shelf Bracket  
CODE **SB/U4**

18mm Plain	18mm Beaded	Modular	Corner Post [Spare]	Flyover Shelf	Decorative Corbel	Large Decorative Corbel	Shelf Bracket
CODE	CODE	CODE	CODE	CODE	CODE	CODE	CODE
<b>2430/650P/18U4</b>	<b>2430/650B/18U4</b>	<b>PIL/MOD900U4</b>	<b>CP/U4</b>	<b>FS/U4</b>	<b>COR/U4</b>	<b>LCOR/U4</b>	<b>SB/U4</b>

Note: Furniture codes beginning with the letter 'R' are assembled (rigid), by removing the 'R' the units are supplied unassembled (flat-pack).

SHAKER  
PRICE GROUP 3  
**OATEN**

Special sizes available  
contact us for further information

Colours Options [PG3]: Cashmere, Dust Grey,  
Graphite, Indigo, Light Grey and Porcelain.



HI-LINE BASE      LOW BASE      HI-LINE CORNER BASE      'L' Shaped

**Pull-Out**

H:720mm  
CODE      WIDTH  
**RBISPO15**      150  
Standard Mechanism inc.  
**RBKPO15**      150  
Kesseböhmer Mechanism inc.  
**RBKTPO15**      150  
Kesseböhmer Mechanism & Towel rail inc.

**Splayed**

H:720mm  
CODE      WIDTH  
**RABA360**      360

**Standard**

H:720mm  
CODE      WIDTH  
**RSBU30**      300  
**RSBU35**      350  
**RSBU40**      400  
**RSBU45**      450  
**RSBU50**      500  
**RSBU60**      600  
**RSBU70#**      700  
**RSBU80#**      800  
**RSBU90#**      900  
**RSBU10#**      1000  
# 2 x Doors

**Low Base**

H:575mm  
CODE      WIDTH  
**RLBU30**      300  
**RLBU40**      400  
**RLBU45**      450  
**RLBU50**      500  
**RLBU60**      600  
**RLBU80#**      800  
**RLBU90#**      900  
**RLBU10#**      1000  
**RLBU12#**      1200  
# 2 x Doors

**Hi-Line Corner Base**

H:720mm  
CODE      WIDTH      CODE      WIDTH  
**RBAC830**      800/300      **RBAC950**      900/500  
**RBAC80**      800/400      **RBAC960**      900/600  
**RBAC845**      800/450      **RBAC140**      1000/400  
**RBAC850**      800/500      **RBAC145**      1000/450  
**RBAC860**      800/600      **RBAC10**      1000/500  
**RBAC940**      900/400      **RBAC160**      1000/600  
**RBAC945**      900/450      **RBAC12**      1200/600

Inc. Corner Post & Blanking Panel

**'L' Shaped**

H:720mm  
CODE      WIDTH  
**BAC90**      900x900  
Bi-fold hinge system  
Flat pack

HI-LINE CORNER BASE      DRAWERLINE BASE      DRAWERLINE SINK BASE      CERAMIC SINK BASE      DRAWERLINE CORNER      BUILT UNDER      2 DRAWER BASE

**Diagonal**

H:720mm  
CODE      WIDTH  
**CDA90**      900x900  
Flat pack

**Single Top Drawer**

H:720mm  
CODE      WIDTH  
**RBD30**      300  
**RBD40**      400  
**RBD45**      450  
**RBD50**      500  
**RBD60**      600  
**RBD80#**      800  
**RBD90#**      900  
**RBD10#**      1000  
**RBD12#**      1200  
# 2 x Doors

**Drawerline Sink Base**

H:720mm  
CODE      WIDTH  
**RBD80/1**      800  
**RBD90/1**      900  
**RBD10/1**      1000

**Ceramic Sink Base**

H:720mm  
CODE      WXH  
**RBDF50**      500  
**RBDF60**      600  
**RBDF80#**      800  
**RBDF90#**      900  
**RBDF10#**      1000  
**RBDD10\*#**      1000  
**RBDD12\*#**      1200  
\*One working drawer  
# 2 x Doors

**Drawerline Corner**

H:720mm  
CODE      WIDTH  
**RBDC830**      800/300  
**RBDC80**      800/400  
**RBDC845**      800/450  
**RBDC850**      800/500  
**RBDC860**      800/600  
**RBDC140**      1000/400  
**RBDC145**      1000/450  
**RBDC10**      1000/500  
**RBDC160**      1000/600  
**RBDC12**      1200/600  
Inc. Corner Post & Blanking Panel

**Built Under**

H:720mm  
CODE      WIDTH  
**RBMU60**      600  
175mm drawer & 110mm filler

**2 Drawer Base**

H:720mm  
CODE      WIDTH  
**RBD250**      500  
**RBD260**      600  
**RBD280**      800  
**RBD290**      900  
**RBD210**      1000  
2x355mm Drawers

3 DRAWER BASE      4 DRAWER BASE      5 DRAWER BASE      LOW WALL      MEDIUM WALL

**3 Drawer Base**

H:720mm  
CODE      WIDTH  
**RBD350**      500  
**RBD360**      600  
**RBD380**      800  
**RBD390**      900  
**RBD310**      1000  
1x140mm, 2x283mm Drawers  
**RBD350/175**      500  
**RBD360/175**      600  
2x175mm, 1x355mm Drawers

**4 Drawer Base**

H:720mm  
CODE      WIDTH  
**RBD450**      500  
**RBD460**      600  
**RBD480**      800  
**RBD490**      900  
**RBD410**      1000  
3x140mm, 1x283mm Drawers  
**RBD450/175**      500  
**RBD460/175**      600  
4x175mm Drawers

**5 Drawer Base**

H:720mm  
CODE      WIDTH  
**RBD530**      300  
**RBD540**      400  
**RBD545**      450  
**RBD550**      500  
**RBD560**      600  
**RBD580**      800  
**RBD590**      900  
**RBD510**      1000  
5x140mm Drawers

**Low Wall**

H:575mm  
CODE      WIDTH      CODE      D:300mm WIDTH  
**RWU30-5**      300      **R2WU60-5\*#**      600  
**RWU40-5**      400      **RWU70-5#**      800  
**RWU45-5**      450      **RWU80-5#**      800  
**RWU50-5**      500      **RWU90-5#**      900  
**RWU60-5**      600      **RWU10-5#**      1000  
\*No muntin [2 x 300 doors]  
# 2 x Doors  
Add 'X' to the end of the code for 350mm deep

**Diagonal Corner**

H:575mm      D:300mm  
CODE      WIDTH      CODE      WIDTH  
**RCWD60-5**      600x600  
Add 'X' to the end of the code for 350mm deep [650x650]

**Medium Wall**

H:720mm      D:300mm  
CODE      WIDTH      CODE      WIDTH  
**RWU30-7**      300      **R2WU60-7\*#**      600  
**RWU35-7**      350      **RWU70-7#**      700  
**RWU40-7**      400      **RWU80-7#**      800  
**RWU45-7**      450      **RWU90-7#**      900  
**RWU50-7**      500      **RWU10-7#**      1000  
**RWU60-7**      600      \*No muntin [2x300 doors]  
# 2 x Doors  
Add 'X' to the end of the code for 350mm deep

MEDIUM WALL

**Glazed Door**

H:720mm      D:300mm  
CODE      WIDTH  
**RWG50-7\***      500  
**RWG10-7\***      1000  
Add 'X' to the end of the code for 350mm deep

**Diagonal Corner**

H:720mm      D:300mm  
CODE      WIDTH  
**RCWD60-7**      600x600  
Add 'X' to the end of the code for 350mm deep [650x650]

**'L' Shaped Corner**

H:720mm      D:300mm  
CODE      WIDTH  
**RCWL60-7**      600x600  
Bi-fold hinge system  
Add 'X' to the end of the code for 350mm deep [650x650]

**Conventional Corner**

H:720mm      D:300mm  
CODE      WIDTH  
**RWUC60-7**      600  
Inc. Corner Post  
Add 'X' to the end of the code for 350mm deep

**Splayed**

H:720mm      D:300mm  
CODE      WIDTH  
**RAWU360-7**      360  
Add 'X' to the end of the code for 350mm deep

**Microwave Wall**

H:720mm      D:300mm  
CODE      WIDTH  
**RMWU60-7**      600  
283mm flap, 110mm filler; Mechanism inc.  
Add 'X' to the end of the code for 350mm deep

**Bi-Fold**

H:720mm      D:300mm  
CODE      WIDTH  
**RBFWU50-7**      500  
**RBFWU60-7**      600  
**RBFWU80-7**      800  
**RBFWU90-7**      900  
**RBFWU10-7**      1000  
Mechanism inc.  
Add 'X' to the end of the code for 350mm deep

TALL WALL

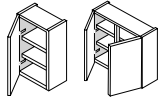

H:900mm	CODE	WIDTH	D:300mm	CODE	WIDTH
	<b>RWU30-9</b>	300		<b>R2WU60-9*</b>	600
	<b>RWU40-9</b>	400		<b>RWU80-9*</b>	800
	<b>RWU45-9</b>	450		<b>RWU90-9*</b>	900
	<b>RWU50-9</b>	500		<b>RWU10-9*</b>	1000
	<b>RWU60-9</b>	600		*No muntin [2x300 doors] #2 x Doors	

Glazed Door

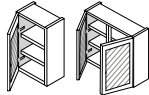

H:900mm	CODE	WIDTH
	<b>RWG50-9*</b>	500
	<b>RWG10-9*</b>	1000

Add 'X' to the end of the code for 350mm deep

Feature Door

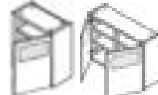

H:900mm	CODE	WIDTH
	<b>RFEWU50-9</b>	500
	<b>RFEWU10-9</b>	1000

Add 'X' to the end of the code for 350mm deep

Diagonal Corner



H:900mm	CODE	D:300mm	WIDTH
	<b>RCWD60-9</b>		600x600

Add 'X' to the end of the code for 350mm deep [650x650]

Splayed



H:900mm	CODE	D:300mm	WIDTH
	<b>RAWU360-9</b>		360

Add 'X' to the end of the code for 350mm deep

Boiler Wall



H:900mm	CODE	WIDTH
	<b>BWU6040-9</b>	600

400mm Deep Flat pack

Add 'X' to the end of the code for 350mm deep

HORIZONTAL WALL

OPEN WALL

OPEN WALL



H:290mm	CODE	D:300mm	WIDTH
	<b>RHWU5029</b>		500
	<b>RHWU6029</b>		600
	<b>RHWU8029</b>		800
	<b>RHWU9029</b>		900
	<b>RHWU1029</b>		1000
	<b>RHWU5036*</b>		500
	<b>RHWU6036*</b>		600
	<b>RHWU8036*</b>		800
	<b>RHWU9036*</b>		900
	<b>RHWU1036*</b>		1000

Add 'X' to the end of the code for 350mm deep



H:290mm	CODE	D:300mm	WIDTH
	<b>RWOS50-2</b>		500
	<b>RWOS60-2</b>		600
	<b>RWOS80-2</b>		800
	<b>RWOS90-2</b>		900
	<b>RWOS10-2</b>		1000

MFC Carcase

If 350mm deep carcase is required adjust code, e.g RWOS1035-2



H:360mm	CODE	D:300mm	WIDTH
	<b>RWOS50-3</b>		500
	<b>RWOS60-3</b>		600
	<b>RWOS80-3</b>		800
	<b>RWOS90-3</b>		900
	<b>RWOS10-3</b>		1000

MFC Carcase

If 350mm deep carcase is required adjust code, e.g RWOS1035-3



H:575mm	CODE	D:300mm	WIDTH
	<b>RWOS30-5</b>		300
	<b>RWOS40-5</b>		400
	<b>RWOS45-5</b>		450
	<b>RWOS50-5</b>		500
	<b>RWOS60-5</b>		600
	<b>RWOS80-5</b>		800
	<b>RWOS90-5</b>		900
	<b>RWOS10-5</b>		1000

MFC Carcase

If 350mm deep carcase is required adjust code, e.g RWOS1035-5



H:720mm	CODE	D:300mm	WIDTH
	<b>RWOS30-7</b>		300
	<b>RWOS40-7</b>		400
	<b>RWOS45-7</b>		450
	<b>RWOS50-7</b>		500
	<b>RWOS60-7</b>		600
	<b>RWOS80-7</b>		800
	<b>RWOS90-7</b>		900
	<b>RWOS10-7</b>		1000

MFC Carcase

If 350mm deep carcase is required adjust code, e.g RWOS1035-7



H:900mm	CODE	D:300mm	WIDTH
	<b>RWOS30-9</b>		300
	<b>RWOS40-9</b>		400
	<b>RWOS45-9</b>		450
	<b>RWOS50-9</b>		500
	<b>RWOS60-9</b>		600
	<b>RWOS80-9</b>		800
	<b>RWOS90-9</b>		900
	<b>RWOS10-9</b>		1000

MFC Carcase

If 350mm deep carcase is required adjust code, e.g RWOS1035-9



H:1210mm	CODE	WIDTH
	<b>RDC1/50</b>	500
	<b>RDC1/60</b>	600

MFC Carcase

If 350mm deep carcase is required adjust code, e.g RDC1/3550

MIDI UNITS

RMLU60	RMA160	RMD060	RMOH560
H:1250mm	H:1250mm	H:1250mm	H:1250mm
CODE	CODE	CODE	CODE
<b>RMLU60</b>	<b>RMA160</b>	<b>RMD060</b>	<b>RMOH560</b>
600	600	600	600

LARDER

RTLU30	RTLID40	RTLID50	RTLID60	TLU80	TLU10
H:1970mm	H:1970mm	H:1970mm	H:1970mm	H:1970mm	H:1970mm
CODE	CODE	CODE	CODE	CODE	CODE
<b>RTLU30</b>	<b>RTLID40</b>	<b>RTLID50</b>	<b>RTLID60</b>	<b>TLU80</b>	<b>TLU10</b>
300	400	500	600	800	1000

\*715mm bottom, 1425mm top door

Drawer Larder

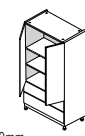

TDLU80	TDLU10
H:1970mm	H:1970mm
CODE	CODE
<b>TDLU80</b>	<b>TDLU10</b>
800	1000

2x355mm Drawers

'L' Shaped

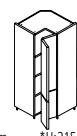

TCLU98	ETCLU98*
H:1970mm	H:1970mm
CODE	CODE
<b>TCLU98</b>	<b>ETCLU98*</b>
985x985	985x985

Bi-fold hinge system

Diagonal

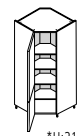

TDCLU1003	ETDCLU1003*
H:1970mm	H:1970mm
CODE	CODE
<b>TDCLU1003</b>	<b>ETDCLU1003*</b>
1003x1003	1003x1003

Diagonal Walk-in Larder

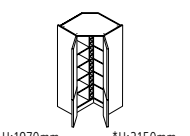

TDWIL1144	ETDWIL1144*
H:1970mm	H:1970mm
CODE	CODE
<b>TDWIL1144</b>	<b>ETDWIL1144*</b>
1144x1144	1144x1144

PULL-OUT LARDER

RTSPOL30	RTKPOL30	RETSPOL30*	RETKPOL30*
H:1970mm	H:1970mm	H:1970mm	H:1970mm
CODE	CODE	CODE	CODE
<b>RTSPOL30</b>	<b>RTKPOL30</b>	<b>RETSPOL30*</b>	<b>RETKPOL30*</b>
300	300	300	300

Standard Mechanism inc.

INNER DRAWER LARDER

RTLID30	RTLID40	RTLID50	RTLID60
H:1970mm	H:1970mm	H:1970mm	H:1970mm
CODE	CODE	CODE	CODE
<b>RTLID30</b>	<b>RTLID40</b>	<b>RTLID50</b>	<b>RTLID60</b>
300	400	500	600

1 x Standard, 4 x Deep drawers

DOUBLE OVEN

RTOHD60	RTOHD60*
H:1970mm	H:1970mm
CODE	CODE
<b>RTOHD60</b>	<b>RTOHD60*</b>
600	600

SINGLE OVEN

RTOHS60	RTOHS60*
H:1970mm	H:1970mm
CODE	CODE
<b>RTOHS60</b>	<b>RTOHS60*</b>
600	600

SINGLE OVEN + COMPACT

RTOHS60	RETOHS60*
H:1970mm	H:1970mm
CODE	CODE
<b>RTOHS60</b>	<b>RETOHS60*</b>
600	600

COMPACT

RTOHC60	RETOHC60*
H:1970mm	H:1970mm
CODE	CODE
<b>RTOHC60</b>	<b>RETOHC60*</b>
600	600

TALL FRIDGE/FREEZER

RTFF1/60	RTFF4/60*	RTFF1U/60#	RTFF4U/60#
H:1970mm	H:1970mm	H:1970mm	H:1970mm
CODE	CODE	CODE	CODE
<b>RTFF1/60</b>	<b>RTFF4/60*</b>	<b>RTFF1U/60#</b>	<b>RTFF4U/60#</b>
600	600	600	600

\*Doors undrilled

# For door on door appliances

TALL FRIDGE/FREEZER

RETFF1/60	RETFF2/60	RETFF3/60*	RETFF1U/60#	RETFF2U/60#	WRFF3U/60*
H:2150mm	H:2150mm	H:2150mm	H:2150mm	H:2150mm	H:2150mm
CODE	CODE	CODE	CODE	CODE	CODE
<b>RETFF1/60</b>	<b>RETFF2/60</b>	<b>RETFF3/60*</b>	<b>RETFF1U/60#</b>	<b>RETFF2U/60#</b>	<b>WRFF3U/60*</b>
600	600	600	600	600	600

# For door on door appliances

\*715mm bottom, 1425mm top door

BOX WINE RACKS

RWR125-7	RWR250-7*	RWR125-9	RWR250-9*	RWR125-1210	WR125-1970	WR250-1970
W:250mm / W:250mm*	W:250mm / W:250mm*	W:250mm / W:250mm*	W:250mm / W:250mm*	W:250mm / W:250mm*	W:250mm / W:250mm*	W:250mm / W:250mm*
CODE	CODE	CODE	CODE	CODE	CODE	CODE
<b>RWR125-7</b>	<b>RWR250-7*</b>	<b>RWR125-9</b>	<b>RWR250-9*</b>	<b>RWR125-1210</b>	<b>WR125-1970</b>	<b>WR250-1970</b>
720	720	900	900	1210	1970	1970

MFC Carcase

If using as base order LEGSET

END SUPPORT PANELS

ESP	900/700
H:900mm	H:900mm
CODE	CODE
<b>ESP</b>	<b>900/700</b>
600	700

MFC Carcase

CARCASE MFC PANELS

1970/300	2150/560	2350/660	720/300	900/2000	900/300
H:1970mm	H:2150mm	H:1970mm	H:1970mm	H:1970mm	H:1970mm
CODE	CODE	CODE	CODE	CODE	CODE
<b>1970/300</b>	<b>2150/560</b>	<b>2350/660</b>	<b>720/300</b>	<b>900/2000</b>	<b>900/300</b>
300x1970	560x2150	660x2350	300x720	2000x900	300x900

MFC Carcase

CORNICE + PELMET

UG/**ET	CO/U2

SHAKER  
PRICE GROUP 3  
**PARKHURST**

Colours Options [PG 3]: Cashmere, Deep Forest, Graphite, Grey, Indigo, Ivory, Lead, Mussel, Navy and White.



HI-LINE BASE LOW BASE

Pull-Out		Curved Door		Splayed		Curved Return [300mm deep]		Shallow Base [300mm deep]				LOW BASE					
H:720mm	WIDTH	CODE	WIDTH	H:720mm	WIDTH	H:720mm	WIDTH	H:720mm	WIDTH	CODE	WIDTH	CODE	WIDTH	H:575mm	WIDTH		
RBA15	150	R2BA60*	600	RBISPO15	150	RCDBA30	300x300	RABA360	360	RCRBA26	260	RSBU30	300	RSBU70#	700	RLBU30	300
RBA26	260	RBA70#	700	Standard Mechanism inc.								RSBU35	350	RSBU80#	800	RLBU40	400
RBA30	300	RBA80#	800	RBKPO15	150							RSBU40	400	RSBU90#	900	RLBU45	450
RBA35	350	RBA90#	900	Kesseböhmer Mechanism inc.								RSBU45	450	RSBU10#	1000	RLBU50	500
RBA40	400	RBA10#	1000	RBKTP015	150							RSBU50	500	# 2 Doors		RLBU60	600
RBA45	450	RBA12#	1200	Kesseböhmer Mechanism & Towel rail inc.								RSBU60	600			RLBU80#	800
RBA50	500	*No muntin [2x300 doors]														RLBU90#	900
RBA60	600	# 2 x Doors														RLBU10#	1000
																RLBU12#	1200
																# 2 x Doors	

HI-LINE CORNER BASE DRAWERLINE BASE DRAWERLINE SINK BASE CERAMIC SINK BASE

'L' Shaped		Diagonal		Single Top Drawer		DRAWERLINE SINK BASE		CERAMIC SINK BASE			
H:720mm	WIDTH	CODE	WIDTH	H:720mm	WIDTH	H:720mm	WIDTH	H:460mm	WIDTH		
RBAC830	800/300	RBAC950	900/500	BAC90	900x900	RBD30	300	RBDF50	500	RB5U60	600
RBAC80	800/400	RBAC960	900/600	Bi-fold hinge system		RBD40	400	RBDF60	600	To suit a sink height of 260mm	
RBAC845	800/450	RBAC140	1000/400	Flatpack		RBD45	450	RBDF80#	800		
RBAC850	800/500	RBAC145	1000/450			RBD50	500	RBDF90#	900		
RBAC860	800/600	RBAC10	1000/500			RBD60	600	RBDF10#	1000		
RBAC940	900/400	RBAC160	1000/600			RBD80#	800	RBDD10*#	1000		
RBAC945	900/450	RBAC12	1200/600			RBD90#	900	RBDD12*#	1200		
						RBD10#	1000	*One working drawer # 2 x Doors			
						RBD12#	1200				

Inc. Corner Post & Blanking Panel

DRAWERLINE CORNER BASE BUILT UNDER 2 DRAWER BASE 3 DRAWER BASE 4 DRAWER BASE 5 DRAWER BASE LOW WALL

Oven		Microwave		2 DRAWER BASE		3 DRAWER BASE		4 DRAWER BASE		5 DRAWER BASE		LOW WALL		Diagonal Corner				
H:720mm	WIDTH	CODE	WIDTH	H:720mm	WIDTH	H:720mm	WIDTH	H:720mm	WIDTH	H:720mm	WIDTH	H:575mm	WIDTH	H:575mm	WIDTH			
RBDC830	800/300	RBDC140	1000/400	RBUM60	600	RBD250	500	RBD350	500	RBD450	500	RBDS30	300	RWU30-5	300	RCWD60-5	600x600	
RBDC80	800/400	RBDC145	1000/450			RBD260	600	RBD360	600	RBD460	600	RBDS40	400	RWU40-5	400	Add 'X' to the end of the code for 350mm deep [650x650]		
RBDC845	800/450	RBDC10	1000/500			RBD280	800	RBD380	800	RBD480	800	RBDS45	450	RWU45-5	450			
RBDC850	800/500	RBDC160	1000/600			RBD290	900	RBD390	900	RBD490	900	RBDS50	500	RWU50-5	500			
RBDC860	800/600	RBDC12	1200/600			RBD210	1000	RBD310	1000	RBD410	1000	RBDS60	600	RWU60-5	600			
						2x355mm Drawers		1x140mm, 2x283mm Drawers		3x140mm, 1x283mm Drawers		RBDS80		800	R2WU60-5*#	600		
								RBD350/175 500		RBD450/175 500		RBDS90		900	RWU60-5	600		
								RBD360/175 600		RBD460/175 600		RBDS10		1000	RWU90-5#	900		
								2 x 175mm, 1x355mm Drawers		4x175mm Drawers		RBDS50		1000	RWU10-5#	1000		
												5x140mm Drawers						
												*No muntin # 2 x Doors						
												Add 'X' to the end of the code for 350mm deep						

Inc. Corner Post & Blanking Panel

MEDIUM WALL

Splayed		Glazed Door		Diagonal Corner		'L' Shaped Corner		Conventional Corner		Splayed		Curved Door					
H:575mm	WIDTH	H:720mm	WIDTH	H:720mm	WIDTH	H:720mm	WIDTH	H:720mm	WIDTH	H:720mm	WIDTH	H:720mm	WIDTH				
RAWU360-5	360	RWU26-7	260	R2WU60-7*#	600	RWG50-7	500	RCWD60-7	600x600	RCWL60-7	600x600	RWUC60-7	600	RAWU360-7	360	RCDWU30-7	300x300
Add 'X' to the end of the code for 350mm deep		RWU30-7	300	RWU70-7#	700	RWG40-7	1000	Add 'X' to the end of the code for 350mm deep [650x650]		Bi-fold hinge system		Inc. Corner Post		Add 'X' to the end of the code for 350mm deep		Add 'X' to the end of the code for 350mm deep	
		RWU35-7	350	RWU80-7#	800	RWG50-7	500										
		RWU40-7	400	RWU90-7#	900												
		RWU45-7	450	RWU10-7#	1000												
		RWU50-7	500	*No muntin [2x300 doors]													
		RWU60-7	600	# 2 x Doors													

Add 'X' to the end of the code for 350mm deep

MEDIUM WALL TALL WALL

Microwave Wall		Bi-Fold		Glazed Door		Diagonal Corner		Splayed		Curved Door							
H:720mm	WIDTH	H:720mm	WIDTH	H:900mm	WIDTH	H:900mm	WIDTH	H:900mm	WIDTH	H:900mm	WIDTH						
RMWU60-7	600	RBFWU50-7	500	RBFWU90-7	900	RWU30-9	300	R2WU60-9*#	600	RWG50-9	500	RCWD60-9	600x600	RAWU360-9	360	RCDWU30-9	300
283mm flap, 110mm filler; Mechanism inc.		RBFWU60-7	600	RBFWU10-7	1000	RWU40-9	400	RWU80-9#	800	RWG40-9	1000	Add 'X' to the end of the code for 350mm deep		Add 'X' to the end of the code for 350mm deep		Add 'X' to the end of the code for 350mm deep	
		RBFWU80-7	800			RWU45-9	450	RWU90-9#	900								
						RWU50-9	500	RWU10-9#	1000								
						RWU60-9	600	*No muntin [2x300 doors] # 2 x Doors									

Add 'X' to the end of the code for 350mm deep

Note: Furniture codes beginning with the letter 'R' are assembled (rigid), by removing the 'R' the units are supplied unassembled (flat-pack).



TALL WALL HORIZONTAL WALL GLAZED DRESSER OPEN WALL

**Boiler Wall**

H:900mm CODE <b>BWU6040-9</b> 400mm Deep Flatpack	WIDTH <b>600</b>
---	---------------------

**H:290mm**  
CODE  
**RHWU5029**  
500  
**RHWU6029**  
600  
**RHWU8029**  
800  
**RHWU9029**  
900  
**RHWU1029**  
1000  
**RHWU5036\***  
500  
**RHWU6036\***  
600  
**RHWU8036\***  
800  
**RHWU9036\***  
900  
**RHWU1036\***  
1000  
Add 'X' to the end of the code for 350mm deep

**\*H:360mm**  
WIDTH  
**RDR2/50**  
500  
Dresser Unit - 1 drawer  
If 350mm deep carcass is required adjust code, e.g RDC2/3550

**H:1210mm**  
CODE  
**RWOS50-2**  
500  
**RWOS60-2**  
600  
**RWOS80-2**  
800  
**RWOS90-2**  
900  
**RWOS10-2**  
1000  
MFC Carcass  
If 350mm deep carcass is required adjust code, e.g RWOS1035-2

**H:290mm**  
CODE  
**RWOS50-3**  
500  
**RWOS60-3**  
600  
**RWOS80-3**  
800  
**RWOS90-3**  
900  
**RWOS10-3**  
1000  
MFC Carcass  
If 350mm deep carcass is required adjust code, e.g RWOS1035-3

**H:360mm**  
CODE  
**RWOS30-5**  
300  
**RWOS40-5**  
400  
**RWOS45-5**  
450  
**RWOS50-5**  
500  
**RWOS60-5**  
600  
**RWOS80-5**  
800  
**RWOS90-5**  
900  
**RWOS10-5**  
1000  
MFC Carcass  
If 350mm deep carcass is required adjust code, e.g RWOS1035-5

**H:575mm**  
CODE  
**RWOS30-7**  
300  
**RWOS40-7**  
400  
**RWOS45-7**  
450  
**RWOS50-7**  
500  
**RWOS60-7**  
600  
**RWOS80-7**  
800  
**RWOS90-7**  
900  
**RWOS10-7**  
1000  
MFC Carcass  
If 350mm deep carcass is required adjust code, e.g RWOS1035-7

**H:720mm**  
CODE  
**RWOS30-9**  
300  
**RWOS40-9**  
400  
**RWOS45-9**  
450  
**RWOS50-9**  
500  
**RWOS60-9**  
600  
**RWOS80-9**  
800  
**RWOS90-9**  
900  
**RWOS10-9**  
1000  
**RDC1/50\***  
500  
**RDC1/60\***  
600  
MFC Carcass  
If 350mm deep carcass is required adjust code, e.g RWOS1035-9

**H:900mm**  
CODE  
**RWOS30-9**  
300  
**RWOS40-9**  
400  
**RWOS45-9**  
450  
**RWOS50-9**  
500  
**RWOS60-9**  
600  
**RWOS80-9**  
800  
**RWOS90-9**  
900  
**RWOS10-9**  
1000  
**RDC1/50\***  
500  
**RDC1/60\***  
600  
MFC Carcass  
If 350mm deep carcass is required adjust code, e.g RWOS1035-9

MIDI UNITS LARDER DRAWER LARDER 'L' SHAPED DIAGONAL WALK-IN LARDER DIAGONAL PULL-OUT LARDER

**RMLU60** **RMA160**  
H:1250mm  
CODE  
**RMLU60**  
600  
**RMA160**  
600  
**RMDO60**  
600  
**ROHS60**  
600

**RMD060** **ROMH560**

**H:1970mm**  
CODE  
**RTL30**  
300  
**RTLU40**  
400  
**RTLU50**  
500  
**RTLU60**  
600  
**TLU80**  
800  
**TLU10**  
1000

**H:2150mm**  
CODE  
**RETL30**  
300  
**RETLU40**  
400  
**RETLU50**  
500  
**RETLU60**  
600  
**ETLU80**  
800  
**ETLU10**  
1000

**H:1970mm**  
CODE  
**TDLU80**  
800  
**TDLU10**  
1000  
2x355mm Drawers

**H:1970mm**  
CODE  
**TCLU98**  
985x985  
**ETCLU98\***  
985x985  
Bi-fold hinge system

**H:1970mm**  
CODE  
**TDWIL1144**  
1144x1144  
**ETDWIL1144\***  
1144x1144

**H:1970mm**  
CODE  
**TDCLU1003**  
1003x1003  
**ETDCLU1003\***  
1003x1003

**H:1970mm**  
CODE  
**RTISPOL30**  
300  
**RTKPOL30**  
300  
Standard Mechanism inc.  
**RETISPOL30\***  
300  
**RETKPOL30\***  
300  
Kessebohmer Mechanism inc.

INNER DRAWER LARDER DOUBLE OVEN SINGLE OVEN SINGLE OVEN + COMPACT COMPACT TALL FRIDGE/FREEZER

**H:1970mm**  
CODE  
**RTLID30**  
300  
**RTLID40**  
400  
**RTLID50**  
500  
**RTLID60**  
600  
1 x Standard, 4 x Deep drawers

**H:2150mm**  
CODE  
**RETLID30**  
300  
**RETLID40**  
400  
**RETLID50**  
500  
**RETLID60**  
600  
1 x Standard, 4 x Deep drawers

**H:1970mm**  
CODE  
**RTOHD60**  
600  
**RTOHDD60**  
600  
**RETOHDD60\***  
600

**H:1970mm**  
CODE  
**RTOSH60**  
600  
**RTOHS60**  
600  
**RETOHS60\***  
600

**H:1970mm**  
CODE  
**RTOHSC60**  
600  
**RETOHSC60\***  
600

**H:1970mm**  
CODE  
**RTOHC60**  
600  
**RETOHC60\***  
600

**H:1970mm**  
CODE  
**RTFF1/60**  
600  
**RTFF4/60\***  
600  
\*Doors supplied undrilled

**RTFF1U/60#**  
600  
**RTFF4U/60#**  
600  
#For door on door appliances

TALL FRIDGE/FREEZER BOX WINE RACKS END SUPPORT PANELS CARCASS MFC PANELS WALL CANOPIES CORNICE COMBI

**H:2150mm**  
CODE  
**RETF1/60**  
600  
**RETF2/60**  
600  
**RETF1U/60#**  
600  
**RETF2U/60#**  
600  
#For door on door appliances

**W:125mm / W:250mm\***  
CODE  
**RWR125-7**  
720  
**RWR250-7\***  
720  
**RWR125-9**  
900  
**RWR250-9\***  
900  
**RWR125-1210**  
1210  
**WR125-1970**  
1970  
**WR250-1970\***  
1970  
MFC Carcass  
If using as base order LEGSET

**H:900mm**  
CODE  
**ESP**  
600  
**900/700**  
700  
MFC Carcass

**H:900mm**  
CODE  
**1970/300**  
300x1970  
**2150/560**  
560x2150  
**2350/660**  
660x2350  
**720/300**  
300x720  
**900/2000**  
2000x900  
**900/300**  
300x900  
MFC Carcass  
**UG/\*ET**  
1000x22  
\*Un-Glued 1m Carcass Edging

**H:450mm**  
CODE  
**EXC100/45T**  
1000  
Can be reduced to 800mm

**H:62mm**  
CODE  
**COH/T\*A**  
3000  
Door Finish

**H:62mm**  
CODE  
**CHCS/T\*A**  
318x318  
Use in conjunction with COH/T\*A  
Door Finish

**H:30mm**  
CODE  
**PCM/T\*A**  
3000  
Door Finish

PLINTH PLANT ON END PANELS PILASTERS FURNITURE ACCS.

**H:30mm**  
CODE  
**CCMS/T\*A**  
318x318  
Use in conjunction with PCM/T  
Door Finish

**H:150mm**  
CODE  
**PL**  
2940  
MFC Carcass  
**PL/T\*A**  
3000  
Door Finish

**H:150mm**  
CODE  
**CPLS/T\*A**  
318x318  
Door Finish  
Use in conjunction with PL/T\*A

**CODE**  
**PST**  
3000

**18mm Plain**  
CODE  
**2350/650/18T\*A**  
650x2350  
**780/355/18T\*A**  
355x780  
**910/600P/T\*A**  
600x910  
**900/650/18T\*A**  
650x900  
**960/355/T\*A**  
355x960  
Door Finish

**18mm Plain Breakfast Bar Panel**  
CODE  
**X900/900/18T\*A**  
900x900  
Door Finish  
\*Not available in Graphite

**Half Gun Barrel**  
H:960mm  
CODE  
**PIL/HGB870**  
100  
Door Finish

**H:715mm**  
CODE  
**CP/T\*A**  
146  
Flat Panel for on site conversion  
Door Finish

FURNITURE ACCESSORIES INTEGRATED DOORS SPARE DOOR FITTINGS GENERAL ACCS.

**H:3000mm**  
CODE  
**RP/T\*A**  
80x80  
Door Finish

**H:28mm**  
CODE  
**RPCMC/T\*A**  
80x80  
Use in conjunction with PCM/T\*A & RP/T\*A  
Door Finish

**H:62mm**  
CODE  
**RPCOH/T\*A**  
80x80  
Use in conjunction with COH/T\*A & RP/T\*A  
Door Finish

**H:1050mm**  
CODE  
**DHSR/BNO**  
350x106

**Undrilled**  
CODE  
**INT4571**  
446x715  
**INT6071**  
596x715

**Hinges [Hettich Soft Close]**  
CODE  
**SCHINGE90**  
90 degree [Pair]  
**SCHINGE170**  
170 degree [Pair]

**Stays [Blum Aventos]**  
CODE  
**BLSTAYHKS**  
HK-S stay [Pair]  
\*[inc mounting brackets]

**CODE**  
**STPWN**  
Set of 2  
Door Strapping Plates  
**LEGSET**  
Set of 4  
Adjustable legs  
**SACC**  
Pk 50  
14mm Self Adhesive Carcass Cover Caps

Note: Furniture codes beginning with the letter 'R' are assembled (rigid), by removing the 'R' the units are supplied unassembled (flat-pack).



SHAKER  
PRICE GROUP 2  
**PENSFORD**

Special sizes available  
contact us for further information

Colours Options [PG 2]: Anthracite, Black, Blush, Cashmere, Dust, Fern, Fjord, Grey, Hunter, Indigo, Mussel, Navy, Porcelain, Terracotta and White.



HI-LINE BASE Pull-Out Curved Door Splayed Curved Return [300mm deep] Shallow Base [300mm deep] LOW BASE

H:720mm		H:720mm		H:720mm		H:720mm		H:720mm		H:720mm		H:720mm		H:575mm	
CODE	WIDTH	CODE	WIDTH	CODE	WIDTH	CODE	WIDTH	CODE	WIDTH	CODE	WIDTH	CODE	WIDTH	CODE	WIDTH
RBA15	150	R2BA60*	600	RBISPO15	150	RCDBA30	300x300	RABA360	360	RCRBA26	260	RSBU30	300	RSBU70#	700
RBA26	260	RBA70#	700	Standard Mechanism inc.						RSBU35	350	RSBU35	350	RSBU80#	800
RBA30	300	RBA80#	800	RBKPO15	150					RSBU40	400	RSBU40	400	RSBU90#	900
RBA35	350	RBA90#	900	Kesseböhmer Mechanism inc.						RSBU45	450	RSBU45	450	RSBU10#	1000
RBA40	400	RBA10#	1000	RBKTP015	150					RSBU50	500	RSBU50	500	# 2 x Doors	
RBA45	450	RBA12#	1200	Kesseböhmer Mechanism & Towel rail inc.						RSBU60	600	RSBU60	600		
RBA50	500	*No muntin [2x300 doors]										RLBU30	300	RLBU40	400
RBA60	600	# 2 x Doors										RLBU45	450	RLBU50	500
												RLBU60	600	RLBU80#	800
												RLBU90#	900	RLBU10#	1000
												RLBU12#	1200	# 2 x Doors	

HI-LINE CORNER BASE DRAWERLINE BASE Single Top Drawer DRAWERLINE SINK BASE CERAMIC SINK BASE

H:720mm		H:720mm		H:720mm		H:720mm		H:720mm		H:720mm		H:460mm			
CODE	WIDTH	CODE	WIDTH	CODE	WIDTH	CODE	WIDTH	CODE	WIDTH	CODE	WIDTH	CODE	WIDTH		
RBAC830	800/300	RBAC950	900/500	BAC90	900x900	CDA90	900x900	RBD30	300	RBD80/1	800	RBDF50	500	RSBU60	600
RBAC80	800/400	RBAC960	900/600	Bi-fold hinge system		Flatpack		RBD40	400	RBD90/1	900	RBDF60	600	To suit a sink height of 260mm	
RBAC845	800/450	RBAC140	1000/400					RBD45	450	RBD10/1	1000	RBDF80#	800		
RBAC850	800/500	RBAC145	1000/450					RBD50	500			RBDF90#	900		
RBAC860	800/600	RBAC10	1000/500					RBD60	600			RBDF10#	1000		
RBAC940	900/400	RBAC160	1000/600					RBD80#	800			RBDD10*#	1000		
RBAC945	900/450	RBAC12	1200/600					RBD90#	900			RBDD12*#	1200		
								RBD10#	1000			*One working drawer			
								RBD12#	1200			# 2 x Doors			

DRAWERLINE CORNER BASE BUILT UNDER 2 DRAWER BASE 3 DRAWER BASE 4 DRAWER BASE 5 DRAWER BASE LOW WALL

H:720mm		H:720mm		H:720mm		H:720mm		H:720mm		H:720mm		H:575mm			
CODE	WIDTH	CODE	WIDTH	CODE	WIDTH	CODE	WIDTH	CODE	WIDTH	CODE	WIDTH	CODE	WIDTH		
RBDC830	800/300	RBDC140	1000/400	RBUM60	600	RBD250	500	RBD350	500	RBD450	500	RBDC830	800/300	RBDC140	1000/400
RBDC80	800/400	RBDC145	1000/450	Microwave		RBD260	600	RBD360	600	RBD460	600	RBDC80	800/400	RBDC145	1000/450
RBDC845	800/450	RBDC10	1000/500			RBD280	800	RBD380	800	RBD480	800	RBDC845	800/450	RBDC10	1000/500
RBDC850	800/500	RBDC160	1000/600			RBD290	900	RBD390	900	RBD490	900	RBDC850	800/500	RBDC160	1000/600
RBDC860	800/600	RBDC12	1200/600			RBD210	1000	RBD310	1000	RBD410	1000	RBDC860	800/600	RBDC12	1200/600
						2x355mm Drawers		1x140mm, 2x283mm Drawers		3x140mm, 1x283mm Drawers					
								RBD350/175	500	RBD450/175	500				
								RBD360/175	600	RBD460/175	600				
								2 x 175mm, 1x355mm Drawers		4x175mm Drawers					
										5x140mm Drawers					

LOW WALL MEDIUM WALL

H:575mm		H:575mm		H:720mm		H:720mm		H:720mm		H:720mm		H:720mm		H:720mm	
CODE	WIDTH	CODE	WIDTH	CODE	WIDTH	CODE	WIDTH	CODE	WIDTH	CODE	WIDTH	CODE	WIDTH	CODE	WIDTH
RCWD60-5	600x600	RAWU360-5	360	RWU26-7	260	R2WU60-7*	600	RWG50-7	500	RCWD60-7	600x600	RCWL60-7	600x600	RWU60-5#	600
Add 'X' to the end of the code for 350mm deep [650x650]		Add 'X' to the end of the code for 350mm deep		RWU30-7	300	RWU70-7#	700	RWG10-7	1000	Add 'X' to the end of the code for 350mm deep [650x650]		Bi-fold hinge system		RWU80-5#	800
				RWU35-7	350	RWU80-7#	800	Add 'X' to the end of the code for 350mm deep				Add 'X' to the end of the code for 350mm deep [650x650]		RWU90-5#	900
				RWU40-7	400	RWU90-7#	900					Add 'X' to the end of the code for 350mm deep		RWU10-5#	1000
				RWU45-7	450	*No muntin [2x300 doors]								*No muntin	
				RWU50-7	500	# 2 x Doors								# 2 x Doors	
				RWU60-7	600										

MEDIUM WALL TALL WALL

H:720mm		H:720mm		H:720mm		H:900mm		H:900mm		H:900mm		H:900mm		H:900mm	
CODE	WIDTH	CODE	WIDTH	CODE	WIDTH	CODE	WIDTH	CODE	WIDTH	CODE	WIDTH	CODE	WIDTH	CODE	WIDTH
RCDWU30	300x300	RMWU60-7	600	RBFWU50-7	500	RWU30-9	300	R2WU60-9*	600	RWG50-9	500	RCWD60-9	600x600	RAWU360-9	360
		283mm flap, 110mm filler; Mechanism inc.		RBFWU60-7	600	RWU40-9	400	RWU80-9#	800	RWG10-9	1000	Add 'X' to the end of the code for 350mm deep [650x650]		Add 'X' to the end of the code for 350mm deep	
				RBFWU80-7	800	RWU45-9	450	RWU90-9#	900	Add 'X' to the end of the code for 350mm deep				400mm Deep	
				RBFWU90-7	900	RWU50-9	500	RWU10-9#	1000					Flatpack	
				RBFWU10-7	1000	*No muntin [2x300 doors]		# 2 x Doors							
						Add 'X' to the end of the code for 350mm deep									

Note: Furniture codes beginning with the letter 'R' are assembled (rigid), by removing the 'R' the units are supplied unassembled (flat-pack).



SHAKER

PRICE GROUP 2

ROMA



Special sizes available  
contact us for further information

Colours Options [PG 2]: Cashmere, Dust Grey, Fern, Grey, Indigo, Oyster, Sage and White.



HI-LINE BASE

LOW BASE

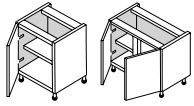

H:720mm CODE	WIDTH	CODE	WIDTH
RBA15	150	R2BA60*	600
RBA25	250	RBA70#	700
RBA30	300	RBA80#	800
RBA35	350	RBA90#	900
RBA40	400	RBA10#	1000
RBA45	450	RBA12#	1200
RBA50	500	*No muntin [2x300 doors]	
RBA60	600	# 2 x Doors	

Pull-Out

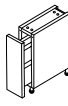

H:720mm CODE	WIDTH	CODE	WIDTH
RBISPO15	150	Standard Mechanism inc.	
RBKPO15	150	Kesseböhmer Mechanism inc.	
RBKTP015	150	Kesseböhmer Mechanism & Towel rail inc.	

Splayed

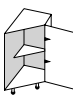

H:720mm CODE	WIDTH
RABA360	360

Shallow Base [300mm deep]

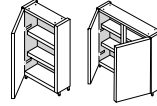

H:720mm CODE	WIDTH	CODE	WIDTH
RSBU30	300	RSBU70#	700
RSBU35	350	RSBU80#	800
RSBU40	400	RSBU90#	900
RSBU45	450	RSBU10#	1000
RSBU50	500	# 2 x Doors	
RSBU60	600		

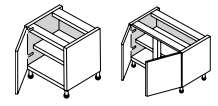

H:575mm CODE	WIDTH	CODE	WIDTH
RLBU30	300	RLBU80#	800
RLBU40	400	RLBU90#	900
RLBU45	450	RLBU10#	1000
RLBU50	500	RLBU12#	1200
RLBU60	600	# 2 x Doors	

HI-LINE CORNER BASE



H:720mm CODE	WIDTH	CODE	WIDTH
RBAC830	800/300	RBAC950	900/500
RBAC80	800/400	RBAC960	900/600
RBAC845	800/450	RBAC140	1000/400
RBAC850	800/500	RBAC145	1000/450
RBAC860	800/600	RBAC10	1000/500
RBAC940	900/400	RBAC160	1000/600
RBAC945	900/450	RBAC12	1200/600

Inc. Corner Post & Blanking Panel

'L' Shaped



H:720mm CODE	WIDTH
BAC90	900x900

Bi-fold hinge system  
Flatpack

Diagonal



H:720mm CODE	WIDTH
CDA90	900x900

Flatpack

DRAWERLINE BASE

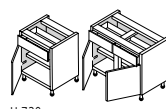

H:720mm CODE	WIDTH	CODE	WIDTH
RBD30	300	RBD80/1	800
RBD40	400	RBD90/1	900
RBD45	450	RBD10/1	1000
RBD50	500		
RBD60	600		
RBD80#	800		
RBD90#	900		
RBD10#	1000		
RBD12#	1200		

# 2 x Doors

Single Top Drawer



H:720mm CODE	WIDTH	CODE	WIDTH
RBD80/1	800		
RBD90/1	900		
RBD10/1	1000		

DRAWERLINE SINK BASE

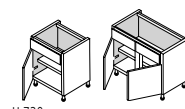

H:720mm CODE	WIDTH	CODE	WIDTH
RBDF50	500		
RBDF60	600		
RBDF80#	800		
RBDF90#	900		
RBDF10#	1000		
RBDD10*#	1000		
RBDD12*#	1200		

\*One working drawer  
# 2 x Doors

CERAMIC SINK BASE

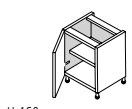

H:460mm CODE	WIDTH
RBSU60	600

To suit a sink height of 260mm

DRAWERLINE CORNER BASE



H:720mm CODE	WIDTH	CODE	WIDTH
RBDC830	800/300	RBDC140	1000/400
RBDC80	800/400	RBDC145	1000/450
RBDC845	800/450	RBDC10	1000/500
RBDC850	800/500	RBDC160	1000/600
RBDC860	800/600	RBDC12	1200/600

Inc. Corner Post & Blanking Panel

BUILT UNDER

Oven



H:720mm CODE	WIDTH
RBU060	600

Microwave



H:720mm CODE	WIDTH
RBUM60	600

175mm drawer & 110mm filler

2 DRAWER BASE

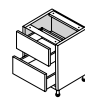

H:720mm CODE	WIDTH	CODE	WIDTH
RBD250	500		
RBD260	600		
RBD280	800		
RBD290	900		
RBD210	1000		

2x355mm Drawers

3 DRAWER BASE

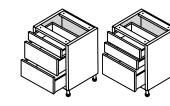

H:720mm CODE	WIDTH	CODE	WIDTH
RBD350	500		
RBD360	600		
RBD380	800		
RBD390	900		
RBD310	1000		

1x140mm, 2x283mm Drawers

4 DRAWER BASE

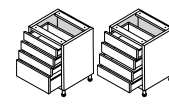

H:720mm CODE	WIDTH	CODE	WIDTH
RBD450	500		
RBD460	600		
RBD480	800		
RBD490	900		
RBD410	1000		

3x140mm, 1x283mm Drawers

5 DRAWER BASE

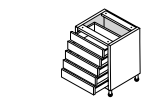

H:720mm CODE	WIDTH	CODE	WIDTH
RBD530	300		
RBD540	400		
RBD545	450		
RBD550	500		
RBD560	600		
RBD580	800		
RBD590	900		
RBD510	1000		

5x140mm Drawers

LOW WALL

MEDIUM WALL

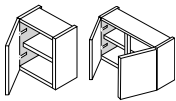

H:575mm CODE	WIDTH	CODE	WIDTH
RWU30-5	300	R2WU60-5*#	600
RWU40-5	400	RWU80-5#	800
RWU45-5	450	RWU90-5#	900
RWU50-5	500	RWU10-5#	1000
RWU60-5	600	*No muntin # 2 x Doors	

Add 'X' to the end of the code for 350mm deep

Diagonal Corner



H:575mm CODE	WIDTH
RCWD60-5	600x600

Add 'X' to the end of the code for 350mm deep [650x650]

Splayed



H:575mm CODE	WIDTH
RAWU360-5	360

Add 'X' to the end of the code for 350mm deep

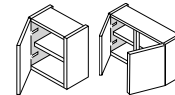

H:720mm CODE	WIDTH	CODE	WIDTH
RWU25-7	250	R2WU60-7*	600
RWU30-7	300	RWU70-7#	700
RWU35-7	350	RWU80-7#	800
RWU40-7	400	RWU90-7#	900
RWU45-7	450	RWU10-7#	1000
RWU50-7	500	*No muntin [2x300 doors]	
RWU60-7	600	# 2 x Doors	

Add 'X' to the end of the code for 350mm deep

Glazed Door

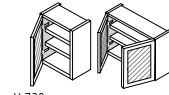

H:720mm CODE	WIDTH	CODE	WIDTH
RWG50-7	500		
RWG10-7	1000		

Add 'X' to the end of the code for 350mm deep

Diagonal Corner

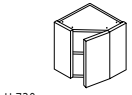

H:720mm CODE	WIDTH
RCWD60-7	600x600

Add 'X' to the end of the code for 350mm deep [650x650]

MEDIUM WALL

'L' Shaped Corner



H:720mm CODE	WIDTH	CODE	WIDTH
RCWL60-7	600x600		

Bi-fold hinge system  
AAdd 'X' to the end of the code for 350mm deep [650x650]

Conventional Corner



H:720mm CODE	WIDTH	CODE	WIDTH
RWUC60-7	600		

Inc. Corner Post  
Add 'X' to the end of the code for 350mm deep

Splayed



H:720mm CODE	WIDTH
RAWU360-7	360

Add 'X' to the end of the code for 350mm deep

Microwave Wall



H:720mm CODE	WIDTH
RMWU60-7	600

283mm flap, 110mm filler; Mechanism inc.  
Add 'X' to the end of the code for 350mm deep

Bi-Fold



H:720mm CODE	WIDTH	CODE	WIDTH
RBFWU50-7	500		
RBFWU60-7	600		
RBFWU80-7	800		
RBFWU90-7	900		
RBFWU10-7	1000		

Mechanism inc.  
Add 'X' to the end of the code for 350mm deep

TALL WALL

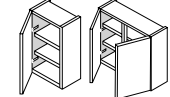

H:900mm CODE	WIDTH	CODE	WIDTH
RWU30-9	300	R2WU60-9*	600
RWU40-9	400	RWU80-9#	800
RWU45-9	450	RWU90-9#	900
RWU50-9	500	RWU10-9#	1000
RWU60-9	600	*No muntin [2x300 doors]	

# 2 x Doors

Add 'X' to the end of the code for 350mm deep

Glazed Door

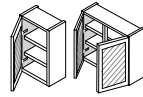

H:900mm CODE	WIDTH
RWG50-9	500
RWG10-9	1000

Add 'X' to the end of the code for 350mm deep

TALL WALL HORIZONTAL WALL GLAZED DRESSER OPEN WALL

**Diagonal Corner**



H:900mm  
CODE  
**RCWD60-9** WIDTH  
600x600  
Add 'X' to the end of the code for 350mm deep [650x650]

**Splayed**

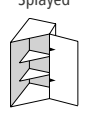

H:900mm  
CODE  
**RAWU360-9** WIDTH  
360  
Add 'X' to the end of the code for 350mm deep

**Boiler Wall**

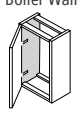

H:900mm  
CODE  
**BWU6040-9** WIDTH  
600  
400mm Deep Flatpack

**HORIZONTAL WALL**

H:290mm CODE <b>RHWU5029</b> WIDTH 500	H:360mm CODE <b>RHWU5036</b> WIDTH 500
<b>RHWU6029</b> 600	<b>RHWU6036</b> 600
<b>RHWU8029</b> 800	<b>RHWU8036</b> 800
<b>RHWU9029</b> 900	<b>RHWU9036</b> 900
<b>RHWU1029</b> 1000	<b>RHWU1036</b> 1000

Add 'X' to the end of the code for 350mm deep

**GLAZED DRESSER**

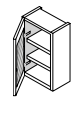

H:1210mm  
CODE  
**RDR1/50** WIDTH  
500  
Dresser Unit - 1 door  
Add 'X' to the end of the code for 350mm deep

**OPEN WALL**

H:290mm CODE <b>RWOS50-2</b> WIDTH 500	H:360mm CODE <b>RWOS50-3</b> WIDTH 500
<b>RWOS60-2</b> 600	<b>RWOS60-3</b> 600
<b>RWOS80-2</b> 800	<b>RWOS80-3</b> 800
<b>RWOS90-2</b> 900	<b>RWOS90-3</b> 900
<b>RWOS10-2</b> 1000	<b>RWOS10-3</b> 1000

MFC Carcase

If 350mm deep carcase is required adjust code, e.g. RWOS1035-2

If 350mm deep carcase is required adjust code, e.g. RWOS1035-3

**OPEN WALL**

H:575mm CODE <b>RWOS30-5</b> WIDTH 300	H:720mm CODE <b>RWOS30-7</b> WIDTH 300	H:900mm CODE <b>RWOS30-9</b> WIDTH 300
<b>RWOS40-5</b> 400	<b>RWOS40-7</b> 400	<b>RWOS40-9</b> 400
<b>RWOS45-5</b> 450	<b>RWOS45-7</b> 450	<b>RWOS45-9</b> 450
<b>RWOS50-5</b> 500	<b>RWOS50-7</b> 500	<b>RWOS50-9</b> 500
<b>RWOS60-5</b> 600	<b>RWOS60-7</b> 600	<b>RWOS60-9</b> 600
<b>RWOS80-5</b> 800	<b>RWOS80-7</b> 800	<b>RWOS80-9</b> 800
<b>RWOS90-5</b> 900	<b>RWOS90-7</b> 900	<b>RWOS90-9</b> 900
<b>RWOS10-5</b> 1000	<b>RWOS10-7</b> 1000	<b>RWOS10-9</b> 1000

MFC Carcase

If 350mm deep carcase is required adjust code, e.g. RWOS1035-5

If 350mm deep carcase is required adjust code, e.g. RWOS1035-7

If 350mm deep carcase is required adjust code, e.g. RWOS1035-9

**MIDI UNITS**

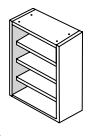

H:1210mm  
CODE  
**RDC1/50** WIDTH  
500  
**RDC1/60** 600  
MFC Carcase

If 350mm deep carcase is required adjust code, e.g. RDC1/3550

**LARDER**

H:1250mm CODE <b>RMLU60</b> WIDTH 600	H:1250mm CODE <b>RMA160</b> WIDTH 600	H:1970mm CODE <b>RTLU30</b> WIDTH 300	H:2150mm CODE <b>RETLU30</b> WIDTH 300
<b>RMD060</b> 600	<b>RMOH560</b> 600	<b>RTLU40</b> 400	<b>RETLU40</b> 400
<b>RMOH560</b> 600		<b>RTLU50</b> 500	<b>RETLU50</b> 500
		<b>RTLU60</b> 600	<b>RETLU60</b> 600
		<b>TLU80</b> 800	<b>ETLU80</b> 800
		<b>TLU10</b> 1000	<b>ETLU10</b> 1000

**LARDER**

H:1970mm CODE <b>TDLU80</b> WIDTH 800	H:1970mm CODE <b>TCLU98</b> WIDTH 985x985	H:1970mm CODE <b>TDWIL1144</b> WIDTH 1144x1144	H:1970mm CODE <b>TDCLU1003</b> WIDTH 1003x1003
<b>TDLU10</b> 1000	<b>ETCLU98*</b> 985x985	<b>ETDWIL1144*</b> 1144x1144	<b>ETDCLU1003*</b> 1003x1003

2x355mm Drawers

Bi-fold hinge system

**PULL-OUT LARDER**

H:1970mm CODE <b>RTISPOL30</b> WIDTH 300	H:1970mm CODE <b>RTKPOL30</b> WIDTH 300	H:1970mm CODE <b>RTLID30</b> WIDTH 300	H:2150mm CODE <b>RETLID30</b> WIDTH 300
<b>RETISPOL30*</b> 300	<b>RETKPOL30*</b> 300	<b>RTLID40</b> 400	<b>RETLID40</b> 400
<b>RETISPOL30*</b> 300	<b>RETKPOL30*</b> 300	<b>RTLID50</b> 500	<b>RETLID50</b> 500
		<b>RTLID60</b> 600	<b>RETLID60</b> 600

Standard Mechanism inc.

Kesseböhmer Mechanism inc.

1 x Standard, 4 x Deep drawers

**DOUBLE OVEN**

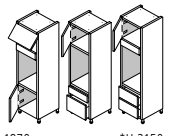

H:1970mm  
CODE  
**RTOHD60** WIDTH  
600
 H:1970mm CODE **RTOHS60** WIDTH 600 || **RTOHD60** 600 | **RTOHS60** 600 |
| **RTOHD60\*** 600 | **RTOHS60\*** 600 |

**SINGLE OVEN**

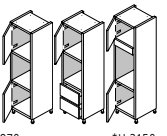

H:1970mm  
CODE  
**RTOHD60** WIDTH  
600
 H:1970mm CODE **RTOHS60** WIDTH 600 || **RTOHD60** 600 | **RTOHS60** 600 |
| **RTOHD60\*** 600 | **RTOHS60\*** 600 |

**SINGLE OVEN + COMPACT**

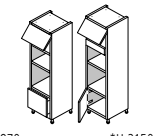

H:1970mm  
CODE  
**RTOHC60** WIDTH  
600
 H:1970mm CODE **RETOHC60\*** WIDTH 600 || **RTOHC60** 600 | **RETOHC60\*** 600 |

**COMPACT**



H:1970mm  
CODE  
**RTOHC60** WIDTH  
600
 H:1970mm CODE **RETOHC60\*** WIDTH 600 || **RTOHC60** 600 | **RETOHC60\*** 600 |

**TALL FRIDGE/FREEZER**

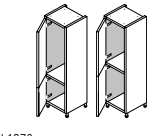

H:1970mm  
CODE  
**RTFF1/60** WIDTH  
600
 H:1970mm CODE **RTFF3/60\*** WIDTH 600 || **RTFF1/60** 600 | **RTFF3/60\*** 600 |
| **RTFF1U/60#** 600 | **RTFF2U/60#** 600 |

**TALL FRIDGE/FREEZER**

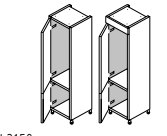

H:2150mm  
CODE  
**RETF1/60** WIDTH  
600
 H:2150mm CODE **RETF2/60** WIDTH 600 || **RETF1/60** 600 | **RETF2/60** 600 |
| **RETF1U/60#** 600 | **RETF2U/60#** 600 |

**BOX WINE RACKS**

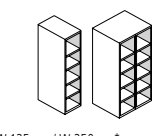

W:125mm / W:250mm\*  
CODE  
**RWR125-7\*** HEIGHT  
720
 CODE **RWR250-7\*** HEIGHT 720 || **RWR125-9** 900 | **RWR250-9** 900 |
| **RWR125-1210** 1210 | **RWR125-1970** 1970 |
| **WR125-1970** 1970 | **WR250-1970\*** 1970 |

**END SUPPORT PANELS**

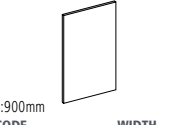

H:900mm  
CODE  
**ESP** WIDTH  
600
 H:900mm CODE **900/700** WIDTH 700 || **ESP** 600 | **900/700** 700 |

**CARCASE MFC PANELS**

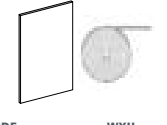

CODE  
**1970/300** WXH  
300x1970
 CODE **2150/560** WXH 560x2150 || **2350/660** 660x2350 | **720/300** 300x720 |
| **900/2000** 2000x900 | **900/300** 300x900 |

**CORNICE - MODERN**

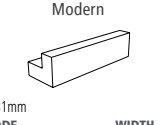

H:31mm  
CODE  
**CM/OF** WIDTH  
3000
 H:31mm CODE **PL** WIDTH 2940 || **CM/OF** 3000 | **PL** 2940 |

**PLINTH**

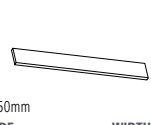

H:150mm  
CODE  
**PL** WIDTH  
2940
 H:150mm CODE **PL/OF** WIDTH 2400 || **PL** 2940 | **PL/OF** 2400 |

**Clear Sealing Strip**

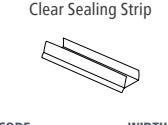

CODE  
**PST** WIDTH  
3000

| **PST** 3000 |

**PLANT ON END PANELS**

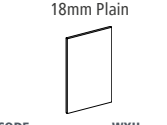

CODE  
**1387/350P/OF** WXH  
350x1387
 CODE **2400/650P/OF** WXH 650x2400 || **2400/650P/OF** 650x2400 | **900/650P/OF** 650x900 |
| **964/350P/OF** 350x964 |  |

**18mm Tongue & Grooved**



CODE  
**1387/350T/18OF** WXH  
350x1387
 CODE **2400/650T/18OF** WXH 650x2400 || **2400/650T/18OF** 650x2400 | **900/650T/18OF** 650x900 |
| **964/350T/18OF** 350x964 |  |

**PLANT ON END PANELS**



CODE  
**915/2400P/OF** WXH  
2400x915

| **915/2400P/OF** 2400x915 |

**18mm Tongue & Grooved Breakfast Bar Panel**



CODE  
**915/2400T/OF** WXH  
2400x915

| **915/2400T/OF** 2400x915 |

**FURNITURE ACCESSORIES**

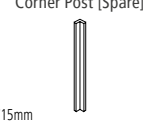

H:715mm  
CODE  
**CP/OF\*2** WIDTH  
146

| **CP/OF\*2** 146 |

**Door Hung Spice Rack**



H:1050mm  
CODE  
**DHSR/BNO** WXD  
350x106

| **DHSR/BNO** 350x106 |

**INTEGRATED DOORS**

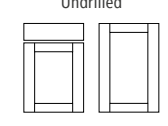

CODE  
**INT4571** WXH  
446x715
 CODE **INT6071** WXH 596x715 || **INT4571** 446x715 | **INT6071** 596x715 |

**SPARE DOOR FITTINGS**

Hinges [Hettich Soft Close]

CODE  
**SCHINGE90** 90 degree [Pair]

CODE  
**SCHINGE170** 170 degree [Pair]

Stays [Blum Aventos]

CODE  
**BLSTAYHKS** HK-S stay [Pair]

**GENERAL ACCS.**

CODE  
**STPWN** Set of 2

Door Strapping Plates

CODE  
**LEGSET** Set of 4

Adjustable legs

CODE  
**SACC** Pk 50

14mm Self Adhesive Cover Caps

Note: Furniture codes beginning with the letter 'R' are assembled (rigid), by removing the 'R' the units are supplied unassembled (flat-pack).







### HORIZONTAL WALL

H:290mm

CODE	WIDTH
RHWU5029	500
RHWU6029	600
RHWU8029	800
RHWU9029	900
RHWU1029	1000

H:360mm

CODE	WIDTH
RHWU5036	500
RHWU6036	600
RHWU8036	800
RHWU1036	900
RHWU1036	1000

Add 'X' to the end of the code for 350mm deep

### GLAZED DRESSER

H:1210mm

CODE	WIDTH
RDR2/50	500
RDRR2/50*	500

\*Reeded glass  
1 drawer  
RCRDR2/50

Add 'X' to the end of the code for 350mm deep

### OPEN WALL

H:290mm

CODE	WIDTH
RWOS50-2	500
RWOS60-2	600
RWOS80-2	800
RWOS90-2	900
RWOS10-2	1000

MFC Carcase

If 350mm deep carcase is required adjust code, e.g. RWOS1035-2

H:360mm

CODE	WIDTH
RWOS50-3	500
RWOS60-3	600
RWOS80-3	800
RWOS90-3	900
RWOS10-3	1000

MFC Carcase

If 350mm deep carcase is required adjust code, e.g. RWOS1035-3

H:575mm

CODE	WIDTH
RWOS30-5	300
RWOS40-5	400
RWOS45-5	450
RWOS50-5	500
RWOS60-5	600
RWOS80-5	800
RWOS90-5	900
RWOS10-5	1000

MFC Carcase

If 350mm deep carcase is required adjust code, e.g. RWOS1035-5

H:720mm

CODE	WIDTH
RWOS30-7	300
RWOS40-7	400
RWOS45-7	450
RWOS50-7	500
RWOS60-7	600
RWOS80-7	800
RWOS90-7	900
RWOS10-7	1000

MFC Carcase

If 350mm deep carcase is required adjust code, e.g. RWOS1035-7

H:900mm

CODE	WIDTH
RWOS30-9	300
RWOS40-9	400
RWOS45-9	450
RWOS50-9	500
RWOS60-9	600
RWOS80-9	800
RWOS90-9	900
RWOS10-9	1000
RDC1/50	500
RDC1/60	600

MFC Carcase

If 350mm deep carcase is required adjust code, e.g. RWOS1035-9

### MIDI UNITS

RMLU60 RMA160

H:1210mm

CODE	WIDTH
RMLU60	600
RMA160	600

RMD060 RMOHS60

H:1250mm

CODE	WIDTH
RMD060	600
RMOHS60	600

### LARDER

H:1970mm

CODE	WIDTH
RTL30	300
RTL40	400
RTL50	500
RTL60	600
TLU80	800
TLU10	1000

### One Cross Rail - Upper Door

H:2150mm

CODE	WIDTH
RETLU30	300
RETLU40	400
RETLU50	500
RETLU60	600
ETLU80	800
ETLU10	1000
RETLU60/1*	600

\*715mm bottom, 1425mm top door

### Single Door - Two Cross Rails

H:1970mm

CODE	WIDTH
RCRTL30	300
RCRTL40	400
RCRTL50	500
RCRTL60	600
CRTLU80	800
CRTLU10	1000

### Drawer Larder

H:1970mm

CODE	WIDTH
TDLU80	800
TDLU10	1000

2x355mm drawers

### 'L' Shaped

H:1970mm \*H:2150mm

CODE	WIDTH
TCLU98	985x985
ETCLU98*	985x985

Bi-fold hinge system

### Diagonal Walk-in Larder

H:1970mm \*H:2150mm

CODE	WIDTH
TDWIL144	1144x1144
ETDWIL144*	1144x1144

### Diagonal

H:1970mm \*H:2150mm

CODE	WIDTH
TDCLU1003	1003x1003
ETDCLU1003*	1003x1003

### PULL-OUT LARDER

H:1970mm \*H:2150mm

CODE	WIDTH
RTISPOL30	300
RTKPOL30	300

Standard Mechanism inc.  
RETISPOL30\* 300  
RETKPOL30\* 300  
Kesseböhmer Mechanism inc.

### INNER DRAWER LARDER

H:1970mm

CODE	WIDTH
RTLID30	300
RTLID40	400
RTLID50	500
RTLID60	600

1 x Standard, 4 x Deep drawers

### DOUBLE OVEN

H:1970mm \*H:2150mm

CODE	WIDTH
ROHDD60	600
ROHDD60*	600
RETOHDD60*	600

### SINGLE OVEN

H:1970mm \*H:2150mm

CODE	WIDTH
ROHS60	600
ROHSD60	600
RETOHS60*	600

### SINGLE OVEN + COMPACT

H:1970mm \*H:2150mm

CODE	WIDTH
ROHSC60	600
RETOHSC60*	600

### COMPACT

H:1970mm \*H:2150mm

CODE	WIDTH
ROHC60	600
RETOHC60*	600

### TALL FRIDGE/FREEZER

H:1970mm

CODE	WIDTH
RTFF1/60	600
RTFF4/60*	600
RTFF1U/60#	600
RTFF2U/60#	600
RTFF3U/60#	600

\*Doors undrilled  
RTFF1U/60# 600  
RTFF4U/60# 600  
#For door on door appliances

### TALL FRIDGE/FREEZER

H:2150mm

CODE	WIDTH
RETFF1/60	600
RETFF2/60	600
RETFF3/60*	600
RETFF1U/60#	600
RETFF2U/60#	600
RETFF3U/60#	600

#For door on door appliances  
\*715mm bottom, 1425mm top door

### BOX WINE RACKS

W:125mm / W:250mm\*

CODE	HEIGHT
RWR125-7	720
RWR250-7*	720
RWR125-9	900
RWR250-9*	900
RWR125-1210	1210
WR125-1970	1970
WR250-1970*	1970

If using as base order LEGSET.  
MFC Carcase

### END SUPPORT PANELS

H:900mm

CODE	WIDTH
ESP	600
900/700	700

MFC Carcase

### CARCASE MFC PANELS

CODE	WXH
1970/300	300x1970
2150/560	560x2150
2350/660	660x2350
720/300	300x720
900/2000	2000x900
900/300	300x900

MFC Carcase  
UG/\*\*ET 1000x22  
\*Un-Glued 1m Carcase Edging

### CORNICE

Contemporary

H:46mm

CODE	WIDTH
COC/B	3000

Classic

H:80mm

CODE	WIDTH
COCL/B	3000

### COMBI

H:28mm

CODE	LENGTH
CCCS/B	3700x370

Use in conjunction with COC/B

Curved Combi Section

H:28mm

CODE	WIDTH
CCMS/B	322x322

Use in conjunction with PCMB/B

### LIGHT BAFFLE

H:50mm

CODE	WIDTH
CLP/B	3100x310

Use in conjunction with LB/B

### PLINTH

H:150mm

CODE	WIDTH
PL	2940

Melamine [Carcase MFC]  
PL/B\* 3000

Door finish

CODE	WIDTH
VFB	3000

Veneered Filler  
Finished on both long edges - can be used as plinth  
\*Includes PST sealing strip

### Decorative Plinth

H:170mm

CODE	WIDTH
DECPL/B	3000

### Decorative Curved Plinth

H:170mm

CODE	WIDTH
CDECPL/B	618x618

### PLANT ON END PANELS

18mm Tongue & Grooved Reversible

CODE	WXH
2440/390T/B	390x2440
2440/650T/B	650x2440
950/390T/B	390x950
885/650T/B	650x885

T&G face has the superior finish  
Painted  
NOT Bone, Cotton, Fern, Putty, Ripptide, Space & Twilight

### 18mm Plain Reversible

CODE	WXH
2440/390P/B	390x2440
2440/650P/B	650x2440
950/390P/B	390x950
885/650P/B	650x885

Plain face has the superior finish  
Painted  
NOT Bone, Cotton, Fern, Putty, Ripptide, Space & Twilight

### 18mm Tongue & Grooved / Plain Reversible

CODE	WXH
2440/390/B	390x2440
2440/650/B	650x2440
950/390/B	390x950
885/650/B	650x885

Painted  
ONLY Bone, Cotton, Fern, Putty, Ripptide, Space & Twilight

### 18mm Tongue & Grooved / Plain Reversible Breakfast Bar Panel

CODE	WXH
900/2000T/B	2000x900

T&G face has the superior finish  
Painted

CODE	WXH
900/2000P/B	2000x900

Plain face has the superior finish  
Painted

CODE	WXH
900/2000/B	2000x900

ONLY Bone, Cotton, Fern, Putty, Ripptide, Space & Twilight

### PILASTERS

Square

H:910mm

CODE	WIDTH
PIL/S910B	50

Curved

CODE	HEIGHT
PIL/CUR910B	910
PIL/CUR1350B	1350
PIL/CUR2150B	2150

W:50mm

CODE	HEIGHT
PIL/CUR910B	910
PIL/CUR1350B	1350
PIL/CUR2150B	2150

### FURNITURE ACCESSORIES

Corner Post [Spare]

H:715mm

CODE	WIDTH
CP/B	146

Flat Panel for on site conversion

### Mantle Shelf

H:25mm

CODE	WXD
MS/B	2400x200

Specify length required - can be made to size

### Decorative Corbel [Single]

H:219mm

CODE	WXD
COR/B	107x95

### Door Hung Spice Rack

H:1050mm

CODE	WXD
DHSR/BNO	350x106

### Undrilled

CODE	WXH
INT4571	446x715
INT6071	596x715

### WINE CAB DOORS

CODE	WXH
WCD607	715x596
WCD6079	1790x596

To suit Caple W1611  
To suit Caple WC1800 wine cabinet

### SPARE DOOR FITTINGS

Hinges [Hettich Soft Close]

CODE
SCHINGE90
SCHINGE170

90 degree [Pair]  
170 degree [Pair]

Stays [Blum Aventos]

CODE
BLSTAYHKS

To suit Caple WC1800 wine cabinet  
\*Incl mounting brackets]

### GENERAL ACCS.

STPWN	Set of 2
LEGSET	Set of 4
SACC	Pk 50
PCC/B	Painted Care Kit
TOUCH/B	Touch Up Paint 500ml



GLAZED DRESSER



H:1210mm	WIDTH
CODE	
<b>RDR2/50</b>	500
1 Drawer	
Add 'X' to the end of the code for 350mm deep	

OPEN WALL

H:290mm	WIDTH	H:360mm	WIDTH	H:575mm	WIDTH	H:720mm	WIDTH	H:900mm	*H:1210mm
CODE		CODE		CODE		CODE		CODE	CODE
<b>RWOS50-2</b>	500	<b>RWOS50-3</b>	500	<b>RWOS30-5</b>	300	<b>RWOS30-7</b>	300	<b>RWOS30-9</b>	300
<b>RWOS60-2</b>	600	<b>RWOS60-3</b>	600	<b>RWOS40-5</b>	400	<b>RWOS40-7</b>	400	<b>RWOS40-9</b>	400
<b>RWOS80-2</b>	800	<b>RWOS80-3</b>	800	<b>RWOS45-5</b>	450	<b>RWOS45-7</b>	450	<b>RWOS45-9</b>	450
<b>RWOS90-2</b>	900	<b>RWOS90-3</b>	900	<b>RWOS50-5</b>	500	<b>RWOS50-7</b>	500	<b>RWOS50-9</b>	500
<b>RWOS10-2</b>	1000	<b>RWOS10-3</b>	1000	<b>RWOS60-5</b>	600	<b>RWOS60-7</b>	600	<b>RWOS60-9</b>	600
MFC Carcase		MFC Carcase		MFC Carcase		MFC Carcase		MFC Carcase	
If 350mm deep carcase is required adjust code, e.g RWOS1035-2		If 350mm deep carcase is required adjust code, e.g RWOS1035-3		If 350mm deep carcase is required adjust code, e.g RWOS1035-5		If 350mm deep carcase is required adjust code, e.g RWOS1035-7		If 350mm deep carcase is required adjust code, e.g RWOS1035-9	

MIDI UNITS

H:1250mm	WIDTH	H:1250mm	WIDTH
CODE		CODE	
<b>RMLU60</b>	600	<b>RMA160</b>	600
<b>RMD060</b>	600	<b>RMOHS60</b>	600
<b>RMOHS60</b>	600		

LARDER

H:1970mm	WIDTH	H:2150mm	WIDTH	H:1970mm	WIDTH	H:1970mm	*H:2150mm	H:1970mm	*H:2150mm	H:1970mm	*H:2150mm	H:1970mm	*H:2150mm
CODE		CODE		CODE		CODE		CODE		CODE		CODE	
<b>RTL30</b>	300	<b>RETL30</b>	300	<b>TDLU80</b>	800	<b>TCLU98</b>	985x985	<b>TDWIL1144</b>	1144x1144	<b>TDCLU1003</b>	1003x1003	<b>RTISPOL30</b>	300
<b>RTL40</b>	400	<b>RETL40</b>	400	<b>TDLU10</b>	1000	<b>ETCLU98*</b>	985x985	<b>ETDWIL1144*</b>	1144x1144	<b>ETDCLU1003*</b>	1003x1003	<b>RTKPOL30</b>	300
<b>RTL50</b>	500	<b>RETL50</b>	500	2x35mm drawers		Bi-fold hinge system						<b>Standard Mechanism inc.</b>	
<b>RTL60</b>	600	<b>RETL60</b>	600									<b>RTISPOL30*</b>	300
<b>TLU80</b>	800	<b>ETLU80</b>	800									<b>RETKPOL30*</b>	300
<b>TLU10</b>	1000	<b>ETLU10</b>	1000									<b>Kesseböhmer Mechanism inc.</b>	
		<b>RETLU60/1*</b>	600										
		*715mm bottom, 1425mm top door											

INNER DRAWER LARDER

H:1970mm	WIDTH	H:2150mm	WIDTH
CODE		CODE	
<b>RTLID30</b>	300	<b>RETLID30</b>	300
<b>RTLID40</b>	400	<b>RETLID40</b>	400
<b>RTLID50</b>	500	<b>RETLID50</b>	500
<b>RTLID60</b>	600	<b>RETLID60</b>	600
1 x Standard, 4 x Deep drawers			

DOUBLE OVEN

H:1970mm	*H:2150mm	H:1970mm	*H:2150mm
CODE		CODE	
<b>RTOHD60</b>	600	<b>RTOHS60</b>	600
<b>RTOHD60*</b>	600	<b>RTOHS60*</b>	600

SINGLE OVEN

H:1970mm	*H:2150mm	H:1970mm	*H:2150mm
CODE		CODE	
<b>RTOHC60</b>	600	<b>RETOHC60*</b>	600

SINGLE OVEN + COMPACT

H:1970mm	*H:2150mm	H:1970mm	*H:2150mm
CODE		CODE	
<b>RTOHC60</b>	600	<b>RETOHC60*</b>	600

COMPACT

H:1970mm	*H:2150mm	H:1970mm	*H:2150mm
CODE		CODE	
<b>RTFF1/60</b>	600	<b>RTFF2/60</b>	600
<b>RTFF3/60*</b>	600	<b>RTFF1U/60*</b>	600
<b>RTFF4/60*</b>	600	<b>RTFF2U/60*</b>	600
<b>RTFF5/60*</b>	600	<b>RTFF3U/60**</b>	600
*Doors undrilled			
# For door on door appliances			
*715mm bottom, 1425mm top door			
•Not Oak			

TALL FRIDGE/FREEZER

H:1970mm	WIDTH	H:2150mm	WIDTH
CODE		CODE	
<b>RTFF1/60</b>	600	<b>RTFF1/60</b>	600
<b>RTFF2/60</b>	600	<b>RTFF2/60</b>	600
<b>RTFF3/60*</b>	600	<b>RTFF3/60*</b>	600
<b>RTFF4/60*</b>	600	<b>RTFF4/60*</b>	600
<b>RTFF5/60*</b>	600	<b>RTFF5/60*</b>	600
<b>RTFF1U/60*</b>	600	<b>RTFF1U/60*</b>	600
<b>RTFF2U/60*</b>	600	<b>RTFF2U/60*</b>	600
<b>RTFF3U/60**</b>	600	<b>RTFF3U/60**</b>	600
*715mm bottom, 1425mm top door			
•Not Oak			

BOX WINE RACKS

W:125mm / W:250mm*	HEIGHT
CODE	
<b>RWR125-7</b>	720
<b>RWR250-7*</b>	720
<b>RWR125-9</b>	900
<b>RWR250-9*</b>	900
<b>RWR125-1210</b>	1210
<b>WR125-1970</b>	1970
<b>WR250-1970</b>	1970
If using as base order LEGSET MFC Carcase	

END SUPPORT PANELS

H:900mm	WIDTH
CODE	
<b>ESP</b>	600
<b>900/700</b>	700
MFC Carcase	

CARCASE MFC PANELS

CODE	WXH
<b>1970/300</b>	300x1970
<b>2150/560</b>	560x2150
<b>2350/660</b>	660x2350
<b>720/300</b>	300x720
<b>900/2000</b>	2000x900
<b>900/300</b>	300x900
MFC Carcase	
<b>UG/*ET</b>	1000x22
*Un-Glued 1m Carcase Edging	

WALL CANOPIES

H:705mm	WIDTH
CODE	
<b>EX100/705US</b>	1000
Can be reduced to 800mm	

CORNICE

Traditional	Modern
H:65mm	H:28mm
CODE	CODE
<b>CO/U</b>	<b>PCM/U</b>
WIDTH	LENGTH
3000	3000
Curved Cornice Section	
H:65mm	H:28mm
CODE	CODE
<b>CCOS/U</b>	<b>CCMS/U</b>
WIDTH	WIDTH
430x430	430x430
Use in conjunction with CO/U	
Use in conjunction with PCM/U	

LIGHT PELMET

H:55mm	WIDTH
CODE	
<b>LB/U</b>	3000
Curved Light Pelmet Section	
H:55mm <td>WIDTH</td>	WIDTH
CODE	
<b>CLPS/U</b>	430x430
Use in conjunction with LB/U	

PLINTH

H:150mm	WIDTH
CODE	
<b>PL</b>	2940
Melamine [Carcase MFC]	
<b>PL/U</b>	3000
Door finish	

PLINTH

H:20mm	WIDTH	H:20mm	WIDTH	CODE	WIDTH
Curved Under Plinth Rail Section		Under Plinth Rail		Clear Sealing Strip	
<b>UPRS/U</b>	570x318	<b>UPR/U</b>	3000	<b>PST</b>	3000

PLANT ON END PANELS

CODE	WXH	CODE	WXH	CODE	WXH	CODE	WXH	CODE	WXH
18mm Tongue & Grooved		18mm Plain		18mm Tongue & Grooved Breakfast Bar Panel		18mm Plain Breakfast Bar Panel		Modular	
<b>2430/650T/18</b>	650x2430	<b>2430/650P/18U</b>	650x2430	<b>900/1200T/18U</b>	1200x900	<b>900/1200P/18U</b>	1200x900	<b>PIL/MOD2400</b>	2400
<b>900/650T/18</b>	650x900	<b>900/650P/18U</b>	650x900	<b>910/2450T/18U</b>	2450x910	<b>910/2450P/18U</b>	2450x910	<b>PIL/MOD900</b>	900
<b>960/360T/18</b>	360x960	<b>960/360P/18U</b>	360x960					<b>PILBEAD*</b>	900

PILASTERS

CODE	HEIGHT
<b>PIL/MOD2400</b>	2400
<b>PIL/MOD900</b>	900
<b>PILBEAD*</b>	900

FURNITURE ACCESSORIES

H:715mm	WIDTH	H:3000mm	WIDTH	H:28mm	WXD	H:1150mm	WXD	H:170mm	D:130mm	H:166mm	WXD	H:65mm	WXD
Corner Post		Radius End Post		Radius End Post Cap - Combi		Pantry Spice Rack		High Mantle Shelf		Decorative Corbel [Pair]		Radius End Post Cap - Cornice	
CODE		CODE		CODE		CODE		CODE		CODE		CODE	
<b>CP/US</b>	146	<b>RP/U</b>	50	<b>RPCMC/U</b>	52x52	<b>PSR/UOA</b>	379x100	<b>MSH/U</b>	1752	<b>COR/U</b>	125x90	<b>RPCO/U</b>	92x92
Flat Panel for on site conversion				Use in conjunction with RP/U & CM/U						Use in conjunction with CO/U & RP/U			

INTEGRATED DOORS

CODE	WXH
<b>INT4571</b>	446x715
<b>INT6071</b>	596x715

WINE CAB DOORS

CODE	WXH
<b>WCD607</b>	715x596
To suit Caple Wi6161	

SPARE DOOR FITTINGS

CODE	DESCRIPTION
<b>SCHINGE90</b>	90 degree [Pair]
<b>SCHINGE170</b>	170 degree [Pair]
Stays [Blum Aventos]	
<b>BLSTAYHKS</b>	HK-S stay [Pair]
*[inc mounting brackets]	

GENERAL ACCS.

CODE	DESCRIPTION
<b>STPWN</b>	Set of 2 Door Strapping Plates
<b>LEGSET</b>	Set of 4 Adjustable legs
<b>SACC</b>	Pk 50 14mm Self Adhesive Cover Caps
<b>TOUCH/U</b>	Touch Up Paint 1ltr

Note: Furniture codes beginning with the letter 'R' are assembled (rigid), by removing the 'R' the units are supplied unassembled (flat-pack).



SHAKER  
PRICE GROUP 7 + 8  
**WOBURN**  
PAINT TO ORDER

*Special sizes available*  
contact us for further information

Colour Options [PG7]: Auburn, Black, Bone, Dusty Rose, Cashmere, Coal, Cotton, Fern, Forest, Mink, Mist, Moss, Navy, Putty, Riptide, Sea Salt, Smoke, Space, Thyme and Twilight.

Bespoke Colour Option [PG8]



**HI-LINE BASE** **Pull-Out** **Curved Door** **Curved Return** **Splayed** **Shallow Base [300mm deep]** **LOW BASE** **HI-LINE CORNER BASE**

HI-LINE BASE				Pull-Out		Curved Door		Curved Return		Splayed		Shallow Base [300mm deep]		LOW BASE		HI-LINE CORNER BASE	
H:720mm				H:720mm		H:720mm		H:720mm		H:720mm		H:720mm		H:720mm		H:720mm	
CODE	WIDTH	CODE	WIDTH	CODE	WIDTH	CODE	WIDTH	CODE	WIDTH	CODE	WIDTH	CODE	WIDTH	CODE	WIDTH	CODE	WIDTH
RBA15	150	R2BA60*	600	RBISPO15	150	RCDBA30	300x300	RCRBA26	260x300	RABA360	360	RSBU30	300	RLBU30	300	BAC90	900x900
RBA26	260	RBA70#	700	Standard Mechanism inc.								RSBU35	350	RLBU40	400	Bi-fold hinge system Flat pack	
RBA30	300	RBA80#	800	RBKPO15 150								RSBU40	400	RLBU45	450	Diagonal	
RBA35	350	RBA90#	900	Kesseböhmer Mechanism inc.								RSBU45	450	RLBU50	500	H:720mm	
RBA40	400	RBA10#	1000	RBKTP015 150								RSBU50	500	RLBU60	600	CODE	
RBA45	450	RBA12#	1200	Kesseböhmer Mechanism & Towel rail inc.								RSBU60	600	RLBU80#	800	CDA90	
RBA50	500	*No muntin [2x300 doors]										RSBU70#	700	RLBU90#	900	900x900	
RBA60	600	# 2 x Doors										RSBU80#	800	RLBU10#	1000	Flat pack	
												RSBU90#	900	RLBU12#	1200		
												RSBU10#	1000	# 2 x Doors			

**HI-LINE CORNER BASE** **DRAWERLINE BASE** **Single Top Drawer** **Open End Island Unit** **DRAWERLINE SINK BASE** **CERAMIC SINK BASE** **DRAWERLINE CORNER BASE**

HI-LINE CORNER BASE				DRAWERLINE BASE				Single Top Drawer		Open End Island Unit		DRAWERLINE SINK BASE				CERAMIC SINK BASE		DRAWERLINE CORNER BASE			
H:720mm				H:720mm				H:720mm		H:870mm		H:720mm				H:720mm					
CODE	WIDTH	CODE	WIDTH	CODE	WIDTH	CODE	WIDTH	CODE	WIDTH	CODE	WIDTH	CODE	WIDTH	CODE	WXH	CODE	WIDTH	CODE	WIDTH		
RBAC830	800/300	RBAC950	900/500	RBD30	300	RBD80/1	800	OEIU9/B**5	910x500	RBD50	500	RBSU60	600x460	RBDC830	800/300	RBDC140	1000/400				
RBAC80	800/400	RBAC960	900/600	RBD40	400	RBD90/1	900	OEIU12/B**5	1170x500	RBD60	600	To suit a sink height of 260mm		RBDC80	800/400	RBDC145	1000/450				
RBAC845	800/450	RBAC140	1000/400	RBD45	450	RBD10/1	1000	Includes drawer box and runners		RBD80#	800			RBDC845	800/450	RBDC10	1000/500				
RBAC850	800/500	RBAC145	1000/450	RBD50	500					RBD90#	900			RBDC850	800/500	RBDC160	1000/600				
RBAC860	800/600	RBAC10	1000/500	RBD60	600					RBD10#	1000			RBDC860	800/600	RBDC12	1200/600				
RBAC940	900/400	RBAC160	1000/600	RBD80#	800					RBD12#	1200			Inc. Corner Post & Blanking Panel							
RBAC945	900/450	RBAC12	1200/600	RBD90#	900																
				RBD10#	1000																
				RBD12#	1200																
				# 2 x Doors																	

**BUILT UNDER** **2 DRAWER BASE** **3 DRAWER BASE** **4 DRAWER BASE** **5 DRAWER BASE** **LOW WALL** **Diagonal Corner** **Splayed**

BUILT UNDER		2 DRAWER BASE		3 DRAWER BASE		4 DRAWER BASE		5 DRAWER BASE		LOW WALL				Diagonal Corner		Splayed	
H:720mm		H:720mm		H:720mm		H:720mm		H:720mm		H:575mm				H:575mm	D:300mm	H:575mm	D:300mm
CODE	WIDTH	CODE	WIDTH	CODE	WIDTH	CODE	WIDTH	CODE	WIDTH	CODE	WIDTH	CODE	WIDTH	CODE	WIDTH	CODE	WIDTH
RBUM60	600	RBD250	500	RBD350	500	RBD450	500	RBD530	300	RWU30-5	300	R2WU60-5*	600	RCWD60-5	600x600	RAWU360-5	360
		RBD260	600	RBD360	600	RBD460	600	RBD540	400	RWU40-5	400	RWU80-5#	800	Add 'X' to the end of the code for 350mm deep [650x650]		Add 'X' to the end of the code for 350mm deep	
		RBD280	800	RBD380	800	RBD480	800	RBD545	450	RWU45-5	450	RWU90-5#	900				
		RBD290	900	RBD390	900	RBD490	900	RBD550	500	RWU50-5	500	RWU10-5#	1000				
		RBD210	1000	RBD310	1000	RBD410	1000	RBD560	600	RWU60-5	600	# 2 x Doors					
		2x355mm Drawers		1x140mm, 2x283mm Drawers		3x140mm, 1x283mm drawers		RBD580 800 RBD590 900 RBD510 1000		Add 'X' to the end of the code for 350mm deep							
H:720mm																	
CODE	WIDTH																
RBUM60	600																
175mm drawer & 110mm filler																	

**MEDIUM WALL** **Glazed Door** **Diagonal Corner** **'L' Shaped Corner** **Conventional Corner** **Splayed** **Curved Door** **Microwave Wall**

MEDIUM WALL		Glazed Door		Diagonal Corner		'L' Shaped Corner		Conventional Corner		Splayed		Curved Door		Microwave Wall	
H:720mm		H:720mm		H:720mm		H:720mm		H:720mm		H:720mm		H:720mm		H:720mm	
CODE	WIDTH	CODE	WIDTH	CODE	WIDTH	CODE	WIDTH	CODE	WIDTH	CODE	WIDTH	CODE	WIDTH	CODE	WIDTH
RWU26-7	260	R2WU60-7*	600	RWG50-7	500	RCWD60-7	600x600	RCWL60-7	600x600	RWU60-7	600	RAWU360-7	360	RCWDU30-7	300x300
RWU30-7	300	RWU70-7#	700	RWG10-7	1000	Add 'X' to the end of the code for 350mm deep [650x650]		Add 'X' to the end of the code for 350mm deep [650x650]		Inc. Corner Post		Add 'X' to the end of the code for 350mm deep		Add 'X' to the end of the code for 350mm deep	
RWU35-7	350	RWU80-7#	800							Add 'X' to the end of the code for 350mm deep					
RWU40-7	400	RWU90-7#	900												
RWU45-7	450	RWU10-7#	1000												
RWU50-7	500	# 2 x Doors													
RWU60-7#	600														
Add 'X' to the end of the code for 350mm deep															

**MEDIUM WALL** **TALL WALL** **Bi-Fold** **Glazed Door** **Diagonal Corner** **Splayed** **Boiler Wall** **HORIZONTAL WALL**

MEDIUM WALL		TALL WALL		Bi-Fold		Glazed Door		Diagonal Corner		Splayed		Boiler Wall		HORIZONTAL WALL			
H:720mm	D:300mm	H:900mm		H:900mm		H:900mm		H:900mm	D:300mm	H:900mm	D:300mm	H:900mm		H:290mm		H:360mm	
CODE	WIDTH	CODE	WIDTH	CODE	WIDTH	CODE	WIDTH	CODE	WIDTH	CODE	WIDTH	CODE	WIDTH	CODE	WIDTH	CODE	WIDTH
RBFWU50-7	500	RWU30-9	300	R2WU60-9*	600	RWG50-9	500	RCWD60-9	600x600	RAWU360-7	360	BWU6040-9	600	RHWU5029	500	RHWU5036	500
RBFWU60-7	600	RWU40-9	400	RWU80-9#	800	RWG10-9	1000	Add 'X' to the end of the code for 350mm deep [650x650]		Add 'X' to the end of the code for 350mm deep		400mm Deep Flat pack		RHWU6029	600	RHWU6036	600
RBFWU80-7	800	RWU45-9	450	RWU90-9#	900	RWGR50-9*	500							RHWU8029	800	RHWU8036	800
RBFWU90-7	900	RWU50-9	500	RWU10-9#	1000	RWGR10-9*	1000							RHWU9029	900	RHWU1036	900
RBFWU10-7	1000	RWU60-9	600	# 2 x Doors		# 2 x Doors								RHWU1029	1000	RHWU1036	1000
Mechanism inc.														Add 'X' to the end of the code for 350mm deep			
Add 'X' to the end of the code for 350mm deep																	

Note: Furniture codes beginning with the letter 'R' are assembled (rigid), by removing the 'R' the units are supplied unassembled (flat-pack).





SHAKER

PRICE GROUP 6 + 8

# WOODFORD

*Special sizes available*  
contact us for further information

PTO Options [PG6]: Calico, Dark Blue, Dark Green, Graphite, Light Grey, Luna and Porcelain.

Bespoke Colour Option [PG8]



HI-LINE BASE | LOW BASE

**HI-LINE BASE**

**Pull-Out**

H:720mm CODE	WIDTH	CODE	WIDTH
RBA15	150	R2BA60*	600
RBA26	260	RBA70#	700
RBA30	300	RBA80#	800
RBA35	350	RBA90#	900
RBA40	400	RBA10#	1000
RBA45	450	RBA12#	1200
RBA50	500		
RBA60	600		

\*No muntin [2x300 doors]  
# 2 x Doors

**Splayed**

H:720mm CODE	WIDTH	H:720mm CODE	WIDTH
RBISPO15	150	RABA360	360

Standard Mechanism inc.  
Kesseböhmer Mechanism inc.  
RBKTP015 150  
Kesseböhmer Mechanism & Towel rail inc.

**Shallow Base [300mm deep]**

H:720mm CODE	WIDTH	CODE	WIDTH
RSBU30	300	RSBU70#	700
RSBU35	350	RSBU80#	800
RSBU40	400	RSBU90#	900
RSBU45	450	RSBU10#	1000
RSBU50	500	#2 x Doors	
RSBU60	600		

**LOW BASE**

H:575mm CODE	WIDTH	CODE	WIDTH
RLBU30	300	RLBU80#	800
RLBU40	400	RLBU90#	900
RLBU45	450	RLBU10#	1000
RLBU50	500	RLBU12#	1200
RLBU60	600	# 2 x Doors	

HI-LINE CORNER BASE | DRAWERLINE BASE | DRAWERLINE SINK BASE | CERAMIC SINK BASE

**HI-LINE CORNER BASE**

**'L' Shaped**

H:720mm CODE	WIDTH	H:720mm CODE	WIDTH
BAC90	900x900	CDA90	900x900

Bi-fold hinge system  
Flat pack

**Diagonal**

H:720mm CODE	WIDTH	H:720mm CODE	WIDTH
RBAC830	800/300	RBAC950	900/500
RBAC80	800/400	RBAC960	900/600
RBAC845	800/450	RBAC140	1000/400
RBAC850	800/500	RBAC145	1000/450
RBAC860	800/600	RBAC10	1000/500
RBAC940	900/400	RBAC160	1000/600
RBAC945	900/450	RBAC12	1200/600

Inc. Corner Post & Blanking Panel

**DRAWERLINE BASE**

H:720mm CODE	WIDTH	H:720mm CODE	WIDTH
RBD30	300	RBD80/1	800
RBD40	400	RBD90/1	900
RBD45	450	RBD10/1	1000
RBD50	500		
RBD60	600		
RBD80#	800		
RBD90#	900		
RBD10#	1000		
RBD12#	1200		

# 2 x Doors

**DRAWERLINE SINK BASE**

H:720mm CODE	WIDTH	H:720mm CODE	WIDTH
RBDF50	500	RBSU60	600x460
RBDF60	600		
RBDF80#	800		
RBDF90#	900		
RBDF10#	1000		
RBDD10*#	1000		
RBDD12*#	1200		

To suit a sink height of 260mm  
\*One working drawer  
# 2 x Doors

**CERAMIC SINK BASE**

DRAWERLINE CORNER BASE | BUILT UNDER | 2 DRAWER BASE | 3 DRAWER BASE | 4 DRAWER BASE | 5 DRAWER BASE | LOW WALL

**DRAWERLINE CORNER BASE**

H:720mm CODE	WIDTH	H:720mm CODE	WIDTH
RBDC830	800/300	RBDC140	1000/400
RBDC80	800/400	RBDC145	1000/450
RBDC845	800/450	RBDC10	1000/500
RBDC850	800/500	RBDC160	1000/600
RBDC860	800/600	RBDC12	1200/600

Inc. Corner Post & Blanking Panel

**BUILT UNDER**

**Oven**

H:720mm CODE	WIDTH	H:720mm CODE	WIDTH
RBU060	600		

**Microwave**

H:720mm CODE	WIDTH	H:720mm CODE	WIDTH
RBUM60	600		

175mm drawer & 110mm filler

**2 DRAWER BASE**

H:720mm CODE	WIDTH	H:720mm CODE	WIDTH
RBD250	500	RBD350	500
RBD260	600	RBD360	600
RBD280	800	RBD380	800
RBD290	900	RBD390	900
RBD210	1000	RBD310	1000

2x355mm Drawers

**3 DRAWER BASE**

H:720mm CODE	WIDTH	H:720mm CODE	WIDTH
RBD350/175	500	RBD450/175	500
RBD360/175	600	RBD460/175	600

1x140mm, 2x283mm Drawers  
2 x 175mm, 1x355mm Drawers

**4 DRAWER BASE**

H:720mm CODE	WIDTH	H:720mm CODE	WIDTH
RBD450	500	RBD530	300
RBD460	600	RBD540	400
RBD480	800	RBD545	450
RBD490	900	RBD550	500
RBD410	1000	RBD560	600
		RBD580	800
		RBD590	900
		RBD510	1000

3x140mm, 1x283mm drawers  
5x140mm Drawers

**5 DRAWER BASE**

**LOW WALL**

H:575mm CODE	WIDTH	CODE	WIDTH
RWU30-5	300	R2WU60-5*#	600
RWU40-5	400	RWU80-5#	800
RWU45-5	450	RWU90-5#	900
RWU50-5	500	RWU10-5#	1000
RWU60-5	600		

\*No muntin [2 x 300 doors]  
# 2 x Doors  
Add 'X' to the end of the code for 350mm deep

MEDIUM WALL

**Glazed Door**

H:720mm CODE	WIDTH	D:300mm CODE	WIDTH
RWU26-7	260	R2WU60-7*#	600
RWU30-7	300	RWU70-7#	700
RWU35-7	350	RWU80-7#	800
RWU40-7	400	RWU90-7#	900
RWU45-7	450	RWU10-7#	1000
RWU50-7	500		
RWU60-7*#	600		

\*No muntin [2x300 doors]  
# 2 x Doors

**Diagonal Corner**

H:720mm CODE	WIDTH	D:300mm CODE	WIDTH
RCWD60-7	600x600		

Add 'X' to the end of the code for 350mm deep [650x650]

**'L' Shaped Corner**

H:720mm CODE	WIDTH	D:300mm CODE	WIDTH
RCWL60-7	600x600		

Bi-fold hinge system  
Add 'X' to the end of the code for 350mm deep [650x650]

**Conventional Corner**

H:720mm CODE	WIDTH	D:300mm CODE	WIDTH
RWUC60-7	600		

Inc. Corner Post  
Add 'X' to the end of the code for 350mm deep

**Splayed**

H:720mm CODE	WIDTH	D:300mm CODE	WIDTH
RAWU360-7	360		

Add 'X' to the end of the code for 350mm deep

**Microwave Wall**

H:720mm CODE	WIDTH	D:300mm CODE	WIDTH
RMWU60-7	600		

283mm flap, 110mm filler; Mechanism inc  
Add 'X' to the end of the code for 350mm deep

Add 'X' to the end of the code for 350mm deep

TALL WALL | HORIZONTAL WALL

**Bi-Fold**

H:720mm CODE	D:300mm WIDTH	H:900mm CODE	WIDTH
RBFWU50-7	500	RWU30-9	300
RBFWU60-7	600	RWU40-9	400
RBFWU80-7	800	RWU45-9	450
RBFWU90-7	900	RWU50-9	500
RBFWU10-7	1000	RWU60-9	600

Mechanism inc.  
Add 'X' to the end of the code for 350mm deep

**Glazed Door**

H:900mm CODE	WIDTH	D:300mm CODE	WIDTH
RWG50-9*	500	R2WU60-9*#	600
RWG10-9*	1000	RWU80-9#	800
		RWU90-9#	900
		RWU10-9#	1000

\*Door style 79mm Shaker frame  
Add 'X' to the end of the code for 350mm deep

**Diagonal Corner**

H:900mm CODE	WIDTH	D:300mm CODE	WIDTH
RCWD60-9	600x600		

Add 'X' to the end of the code for 350mm deep [650x650]

**Splayed**

H:900mm CODE	WIDTH	D:300mm CODE	WIDTH
RAWU360-9	360		

Add 'X' to the end of the code for 350mm deep

**Boiler Wall**

H:900mm CODE	WIDTH	D:300mm CODE	WIDTH
BWU6040-9	600		

400mm Deep  
Flat pack

**HORIZONTAL WALL**

H:290mm CODE	*H:360mm WIDTH
RHWU5029	500
RHWU6029	600
RHWU8029	800
RHWU9029	900
RHWU1029	1000
RHWU5036*	500
RHWU6036*	600
RHWU8036*	800
RHWU1036*	1000

Add 'X' to the end of the code for 350mm deep

Note: Furniture codes beginning with the letter 'R' are assembled (rigid), by removing the 'R' the units are supplied unassembled (flat-pack).

GLAZED DRESSER

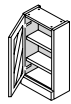

H:1210mm  
**CODE WIDTH**  
**RDR2/50\*** 500  
 1 Drawer  
 \*Door style 79mm Shaker frame  
 Add 'X' to the end of the code for 350mm deep

OPEN WALL



H:290mm  
**CODE WIDTH**  
**RWOS50-2** 500  
**RWOS60-2** 600  
**RWOS80-2** 800  
**RWOS90-2** 900  
**RWOS10-2** 1000  
 MFC Carcase

If 350mm deep carcase is required  
 adjust code, e.g. RWOS1035-2



H:360mm  
**CODE WIDTH**  
**RWOS50-3** 500  
**RWOS60-3** 600  
**RWOS80-3** 800  
**RWOS90-3** 900  
**RWOS10-3** 1000  
 MFC Carcase

If 350mm deep carcase is required  
 adjust code, e.g. RWOS1035-3



H:575mm  
**CODE WIDTH**  
**RWOS30-5** 300  
**RWOS40-5** 400  
**RWOS45-5** 450  
**RWOS50-5** 500  
**RWOS60-5** 600  
**RWOS80-5** 800  
**RWOS90-5** 900  
**RWOS10-5** 1000  
 MFC Carcase

If 350mm deep carcase is required  
 adjust code, e.g. RWOS1035-5



H:720mm  
**CODE WIDTH**  
**RWOS30-7** 300  
**RWOS40-7** 400  
**RWOS45-7** 450  
**RWOS50-7** 500  
**RWOS60-7** 600  
**RWOS80-7** 800  
**RWOS90-7** 900  
**RWOS10-7** 1000  
 MFC Carcase

If 350mm deep carcase is required  
 adjust code, e.g. RWOS1035-7



H:900mm \*H:1210mm  
**CODE WIDTH**  
**RWOS30-9** 300  
**RWOS40-9** 400  
**RWOS45-9** 450  
**RWOS50-9** 500  
**RWOS60-9** 600  
**RWOS80-9** 800  
**RWOS90-9** 900  
**RWOS10-9** 1000  
**RDC1/50\*** 500  
**RDC1/60\*** 600  
 MFC Carcase

If 350mm deep carcase is required  
 adjust code, e.g. RWOS1035-9

MIDI UNITS

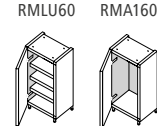

H:1250mm  
**CODE WIDTH**  
**RMLU60** 600  
**RMA160** 600

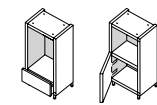

H:1250mm  
**CODE WIDTH**  
**RMD060** 600  
**RMOHS60** 600

LARDER

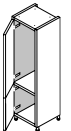

H:1970mm  
**CODE WIDTH**  
**RTLU30** 300  
**RTLU40** 400  
**RTLU50** 500  
**RTLU60** 600  
**TLU80** 800  
**TLU10** 1000

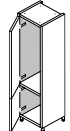

H:2150mm  
**CODE WIDTH**  
**RETLU30** 300  
**RETLU40** 400  
**RETLU50** 500  
**RETLU60** 600  
**ETLU80** 800  
**ETLU10** 1000  
**RETLU60/1\*** 600  
 \*715mm bottom, 1425mm top door

Single Door - Two Cross Rails

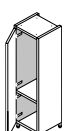

H:1970mm  
**CODE WIDTH**  
**RCRTLUSD30** 300  
**RCRTLUSD40** 400  
**RCRTLUSD50** 500  
**RCRTLUSD60** 600

Drawer Larder



H:1970mm  
**CODE WIDTH**  
**TDLU80** 800  
**TDLU10** 1000  
 2x355mm drawers

'L' Shaped

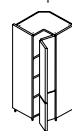

H:1970mm \*H:2150mm  
**CODE WIDTH WIDTH**  
**TCLU98** 985x985  
**ETCLU98\*** 985x985  
 Bi-fold hinge system

Diagonal Walk-in Larder

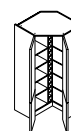

H:1970mm \*H:2150mm  
**CODE WIDTH WIDTH**  
**TDWIL1144** 1144x1144  
**ETDWIL1144\*** 1144x1144

Diagonal

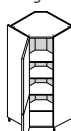

H:1970mm \*H:2150mm  
**CODE WIDTH WIDTH**  
**TDCLU1003** 1003x1003  
**ETDCLU1003\*** 1003x1003

PULL-OUT LARDER

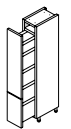

H:1970mm \*H:2150mm  
**CODE WIDTH WIDTH**  
**RTISPOL30** 300  
**RTKPOL30** 300  
 Standard Mechanism inc.  
**RETISPOL30\*** 300  
**RETKPOL30\*** 300  
 Kesseböhmer Mechanism

INNER DRAWER LARDER

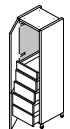

H:1970mm  
**CODE WIDTH**  
**RTLID30** 300  
**RTLID40** 400  
**RTLID50** 500  
**RTLID60** 600

DOUBLE OVEN

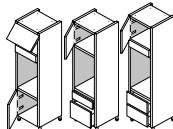

H:1970mm \*H:2150mm  
**CODE WIDTH WIDTH**  
**RTOHD60** 600  
**RTOHDD60** 600  
**RTOHDD60\*** 600

SINGLE OVEN

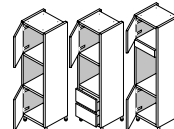

H:1970mm \*H:2150mm  
**CODE WIDTH WIDTH**  
**RTOHS60** 600  
**RTOHSD60** 600  
**RTOHS60\*** 600

SINGLE OVEN + COMPACT

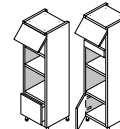

H:1970mm \*H:2150mm  
**CODE WIDTH WIDTH**  
**RTOHSC60** 600  
**RETOHSC60\*** 600

COMPACT

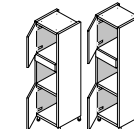

H:1970mm \*H:2150mm  
**CODE WIDTH WIDTH**  
**RTOHC60** 600  
**RETOHC60\*** 600

TALL FRIDGE/FREEZER

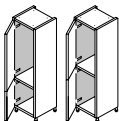

H:1970mm  
**CODE WIDTH**  
**RTFF1/60** 600  
**RTFF4/60\*** 600  
 \*Doors undrilled  
**RTFF1U/60#** 600  
**RTFF4U/60#** 600  
 # For door on door appliances

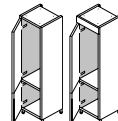

H:2150mm  
**CODE WIDTH**  
**RETF1/60** 600  
**RETF2/60** 600  
**RETF3/60\*** 600  
**RETF1U/60#** 600  
**RETF2U/60#** 600  
**RETF3U/60#\*** 600  
 # For door on door appliances  
 \*715mm bottom, 1425mm top door

BOX WINE RACKS

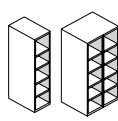

W:125mm / W:250mm\*  
**CODE HEIGHT**  
**RWR125-7** 720  
**RWR250-7\*** 720  
**RWR125-9** 900  
**RWR250-9\*** 900  
**RWR125-1210** 1210  
**WR125-1970** 1970  
**WR250-1970** 1970  
 MFC Carcase  
 If using as base order LEGSET

END SUPPORT PANELS



H:900mm  
**CODE WIDTH**  
**ESP** 600  
**900/700** 700  
 MFC Carcase

CARCASE MFC PANELS

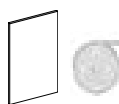

**CODE WXH**  
**1970/300** 300x1970  
**2150/560** 560x2150  
**2350/660** 660x2350  
**720/300** 300x720  
**900/2000** 2000x900  
**900/300** 300x900  
 MFC Carcase  
**UG/\*\*ET** 1000x22  
 \*Un-Glued 1m Carcase Edging

CORNICE/PELMET



H:18mm  
**CODE D:70mm**  
**PCM/MP** 3000  
 Painted

PLINTH



H:150mm  
**CODE WIDTH**  
**PL** 2940  
 Melamine (Carcase MFC)  
**PL/MP** 3000  
 Painted

Clear Sealing Strip



**CODE WIDTH**  
**PST** 3000

PLANT ON END PANELS

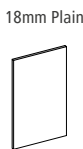

**CODE WXH**  
**2400/650P/MP** 650x2400  
**800/375P/MP** 375x800  
**900/650P/MP** 650x900  
**960/375P/MP** 375x960  
**900/1200P/MP** 1200x900  
**900/2400P/MP** 2400x900  
 Painted

18mm Tounge & Grooved



**CODE WXH**  
**2400/650T/MP** 650x2400  
**800/375T/MP** 375x800  
**900/650T/MP** 650x900  
**960/375T/MP** 375x960  
**900/1200T/MP** 1200x900  
**900/2200T/MP** 2200x900  
 Painted

PILASTERS

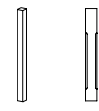

H:900mm/2400mm\*  
**CODE WXD**  
**PIL/S2400MP\*** 50x75  
**PIL/S900MP** 68x68  
 Square Painted  
**PIL/SC900MP** 68x68  
 Chamfered Painted

FURNITURE ACCESSORIES



H:1050mm  
**CODE WXD**  
**DHSR/BNO** 350x106

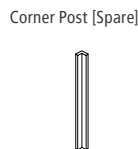

H:715mm  
**CODE WIDTH**  
**CP/MP\*\*** 146  
 Painted

INTEGRATED DOORS

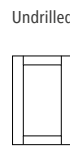

**CODE WXH**  
**INT4571** 446x715  
**INT6071** 596x715

SPARE DOOR FITTINGS

Hinges [Hettich Soft Close]

**CODE**  
**SCHINGE90**  
 90 degree [Pair]  
**SCHINGE170**  
 170 degree [Pair]

Stays [Blum Aventos]

**CODE**  
**BLSTAYHK5**  
 HK-5 stay [Pair]  
 \*[inc mounting brackets]

GENERAL ACCS.

**CODE**  
**STPWN** Set of 2  
 Door Strapping Plates  
**LEGSET** Set of 4  
 Adjustable legs  
**SACC** Pk 50  
 14mm Self Adhesive Cover Caps  
**PCC/MP**  
 Painted Care Kit





## J-Handle

Experience a kitchen that exudes modern elegance and sophistication. The cabinets, with their integrated 'J' style handles, not only add a touch of contemporary charm but also ensure uncluttered lines that flow throughout your space.

This design is available in both high gloss for a vibrant, reflective finish, and silk smooth matt for a subtle, tactile touch.

J-HANDLE

PRICE GROUP 4

# METZ GLOSS

Special sizes available  
contact us for further information

Colours Options [PG4]: Graphite, Light Grey, Savanna, and White.



HI-LINE BASE

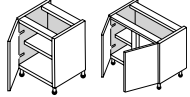

H:720mm

CODE	WIDTH	CODE	WIDTH
RBA15	150	R2BA60*	600
RBA26	260	RBA70#	700
RBA30	300	RBA80#	800
RBA35	350	RBA90#	900
RBA40	400	RBA10#	1000
RBA45	450	RBA12#	1200
RBA50	500	*No muntin [2x300 doors]	
RBA60	600	# 2 x Doors	

Pull-Out



H:720mm

CODE	WIDTH
RBISPO15	150

Standard Mechanism inc.

CODE	WIDTH
RBKPO15	150

Kesseböhmer Mechanism inc.

CODE	WIDTH
RBKTP015	150

Kesseböhmer Mechanism & Towel rail inc.

Curved Return  
[300mm deep]



H:720mm

CODE	WIDTH
RCRBA26	260

Curved Door



H:720mm

CODE	WIDTH
RCDRBA30	300x300

Splayed



H:720mm

CODE	WIDTH
RABA360	360

LOW BASE

Shallow Base  
[300mm deep]

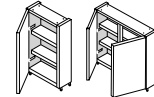

H:720mm

CODE	WIDTH
RSBU30	300
RSBU35	350
RSBU40	400
RSBU45	450
RSBU50	500
RSBU60	600
RSBU70#	700
RSBU80#	800
RSBU90#	900
RSBU10#	1000

# 2 x Doors

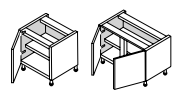

H:575mm

CODE	WIDTH
RLBU30	300
RLBU40	400
RLBU45	450
RLBU50	500
RLBU60	600
RLBU80#	800
RLBU90#	900
RLBU10#	1000
RLBU12#	1200

# 2 x Doors

HI-LINE CORNER BASE



H:720mm

CODE	WIDTH	CODE	WIDTH
RBAC830	800/300	RBAC950	900/500
RBAC80	800/400	RBAC960	900/600
RBAC845	800/450	RBAC140	1000/400
RBAC850	800/500	RBAC145	1000/450
RBAC860	800/600	RBAC10	1000/500
RBAC940	900/400	RBAC160	1000/600
RBAC945	900/450	RBAC12	1200/600

Inc. 60x60mm Corner Post & Blanking Panel

'L' Shaped



H:720mm

CODE	WIDTH
BAC90	900x900

Bi-fold hinge system  
Flatpack

Diagonal



H:720mm

CODE	WIDTH
CDA90	900x900

Flatpack

DRAWERLINE BASE

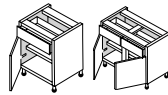

H:720mm

CODE	WIDTH	CODE	WIDTH
RBD30	300	RBD80#	800
RBD40	400	RBD90#	900
RBD45	450	RBD10#	1000
RBD50	500	RBD12#	1200
RBD60	600	# 2 x Doors	

DRAWERLINE SINK BASE

Single Top Drawer



H:720mm

CODE	WIDTH
RBD80/1	800
RBD90/1	900
RBD10/1	1000

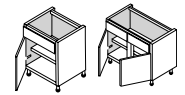

H:720mm

CODE	WIDTH
RBDF50	300
RBDF60	400
RBDF80#	450
RBDF90#	500
RBDF10#	600
RBDD10*#	800
RBDD12*#	900

\*One working drawer  
# 2 x Doors

CERAMIC SINK BASE



H:460mm

CODE	WIDTH
RBSU60	600

To suit a sink height of 260mm

DRAWERLINE CORNER BASE



H:720mm

CODE	WIDTH	CODE	WIDTH
RBDC830	800/300	RBDC140	1000/400
RBDC80	800/400	RBDC145	1000/450
RBDC845	800/450	RBDC10	1000/500
RBDC850	800/500	RBDC160	1000/600
RBDC860	800/600	RBDC12	1200/600

Inc. 60x60mm Corner Post & Blanking Panel

BUILT UNDER



H:720mm

CODE	WIDTH
RBU060	600

Microwave



H:720mm

CODE	WIDTH
RBUM60	600

175mm drawer & 110mm filler

2 DRAWER BASE



H:720mm

CODE	WIDTH
RBD250	500
RBD260	600
RBD280	800
RBD290	900
RBD210	1000

2x355mm Drawers

3 DRAWER BASE

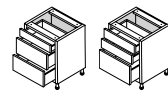

H:720mm

CODE	WIDTH
RBD350	500
RBD360	600
RBD380	800
RBD390	900
RBD310	1000

1x140mm, 2x283mm Drawers

RBD350/175 500  
RBD360/175 600  
2x175mm, 1x355mm Drawers

4 DRAWER BASE

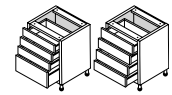

H:720mm

CODE	WIDTH
RBD450	500
RBD460	600
RBD480	800
RBD490	900
RBD410	1000

3x140mm, 1x283mm Drawers

RBD450/175 500  
RBD460/175 600  
4x175mm Drawers

5 DRAWER BASE



H:720mm

CODE	WIDTH
RBD530	300
RBD540	400
RBD545	450
RBD550	500
RBD560	600
RBD580	800
RBD590	900
RBD510	1000

5x140mm Drawers

LOW WALL

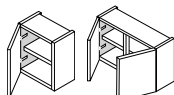

H:575mm

CODE	WIDTH	CODE	WIDTH
RWU30-5	300	RWU90-5*#	900
RWU40-5	400	RWU10-5*#	1000
RWU45-5	450	*No muntin [2x300 doors]	
RWU50-5	500	# 2 x Doors	
RWU60-5	600	Add 'X' to the end of the code for 350mm deep	
R2WU60-5*#	600		
RWU80-5*#	800		

Diagonal Corner



H:575mm

CODE	WIDTH
RCWD60-5	600x600

Add 'X' to the end of the code for 350mm deep [650x650]

Splayed



H:575mm

CODE	WIDTH
RAWU360-5	360

Add 'X' to the end of the code for 350mm deep

MEDIUM WALL

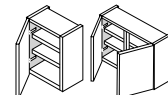

H:720mm

CODE	WIDTH	CODE	WIDTH
RWU26-7	260	R2WU60-7*	600
RWU30-7	300	RWU70-7#	700
RWU35-7	350	RWU80-7#	800
RWU40-7	400	RWU90-7#	900
RWU45-7	450	RWU10-7#	1000
RWU50-7	500	*No muntin [2x300 doors]	
RWU60-7	600	#2xDoors	

Add 'X' to the end of the code for 350mm deep

Diagonal Corner



H:720mm

CODE	WIDTH
RCWD60-7	600x600

Add 'X' to the end of the code for 350mm deep [650x650]

MEDIUM WALL

'L' Shaped Corner



H:720mm

CODE	WIDTH
RCWL60-7	600x600

Bi-fold hinge system  
300 Door  
Add 'X' to the end of the code for 350mm deep [650x650]

Conventional Corner



H:720mm

CODE	WIDTH
RWUC60-7	600

300 Door  
RWUC260-7 600  
260 Door  
Inc. 60x60mm Corner Post  
Add 'X' to the end of the code for 350mm deep

Splayed



H:720mm

CODE	WIDTH
RAWU360-7	360

Add 'X' to the end of the code for 350mm deep

Curved Door



H:720mm

CODE	WIDTH
RCDWU30-7	300x300

Microwave Wall



H:720mm

CODE	WIDTH
RMWU60-7	600

283mm flap, 110mm filler; Mechanism inc.  
Add 'X' to the end of the code for 350mm deep

Bi-Fold



H:720mm

CODE	WIDTH
RBFWU60-7	600
RBFWU80-7	800
RBFWU90-7	900
RBFWU10-7	1000

Mechanism inc.  
Add 'X' to the end of the code for 350mm deep

TALL WALL

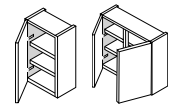

H:900mm

CODE	WIDTH	CODE	WIDTH
RWU30-9	300	R2WU60-9*#	600
RWU40-9	400	RWU80-9#	800
RWU45-9	450	RWU90-9#	900
RWU50-9	500	RWU10-9#	1000
RWU60-9	600	*No muntin [2x300 doors]	

#2xDoors  
Add 'X' to the end of the code for 350mm deep

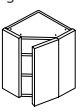
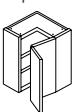
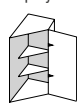
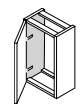

TALL WALL HORIZONTAL WALL OPEN WALL

<p><b>Diagonal Corner</b></p>  <p>H:900mm CODE <b>RCWD60-9</b> WIDTH 600x600 Add 'X' to the end of the code for 350mm deep [650x650]</p>	<p><b>'L' Shaped Corner</b></p>  <p>H:900mm CODE <b>RCWL60-9</b> WIDTH 600x600 Add 'X' to the end of the code for 350mm deep [650x650]</p>	<p><b>Splayed</b></p>  <p>H:900mm CODE <b>RAWU360-9</b> WIDTH 360 Add 'X' to the end of the code for 350mm deep</p>	<p><b>Boiler Wall</b></p>  <p>H:900mm CODE <b>BWU6040-9</b> WIDTH 600 400mm Deep Flatpack</p>	<p><b>H:290mm</b> CODE <b>RHWU5029</b> WIDTH 500 <b>RHWU6029</b> 600 <b>RHWU8029</b> 800 <b>RHWU9029</b> 900 <b>RHWU1029</b> 1000 <b>RHWU5036</b> 500 <b>RHWU6036</b> 600 <b>RHWU8036</b> 800 <b>RHWU9036</b> 900 <b>RHWU1036</b> 1000 Add 'X' to the end of the code for 350mm deep</p>	<p><b>H:360mm</b> CODE <b>RWOS50-2</b> WIDTH 500 <b>RWOS60-2</b> 600 <b>RWOS80-2</b> 800 <b>RWOS90-2</b> 900 <b>RWOS10-2</b> 1000 MFC Carcase</p>	<p><b>H:290mm</b> CODE <b>RWOS50-3</b> WIDTH 500 <b>RWOS60-3</b> 600 <b>RWOS80-3</b> 800 <b>RWOS90-3</b> 900 <b>RWOS10-3</b> 1000 MFC Carcase</p>	<p><b>H:360mm</b> CODE <b>RWOS50-3</b> WIDTH 500 <b>RWOS60-3</b> 600 <b>RWOS80-3</b> 800 <b>RWOS90-3</b> 900 <b>RWOS10-3</b> 1000 MFC Carcase</p>	<p><b>H:575mm</b> CODE <b>RWOS30-5</b> WIDTH 300 <b>RWOS40-5</b> 400 <b>RWOS45-5</b> 450 <b>RWOS50-5</b> 500 <b>RWOS60-5</b> 600 <b>RWOS80-5</b> 800 <b>RWOS90-5</b> 900 <b>RWOS10-5</b> 1000 MFC Carcase</p>
---	---	--	--	--	---	---	---	---

OPEN WALL MIDI UNITS LARDER

<p><b>H:720mm</b> CODE <b>RWOS30-7</b> WIDTH 300 <b>RWOS40-7</b> 400 <b>RWOS45-7</b> 450 <b>RWOS50-7</b> 500 <b>RWOS60-7</b> 600 <b>RWOS80-7</b> 800 <b>RWOS90-7</b> 900 <b>RWOS10-7</b> 1000 MFC Carcase</p>	<p><b>H:900mm</b> CODE <b>RWOS30-9</b> WIDTH 300 <b>RWOS40-9</b> 400 <b>RWOS45-9</b> 450 <b>RWOS50-9</b> 500 <b>RWOS60-9</b> 600 <b>RWOS80-9</b> 800 <b>RWOS90-9</b> 900 <b>RWOS10-9</b> 1000 MFC Carcase</p>	<p><b>H:1210mm</b> CODE <b>RDC1/50</b> WIDTH 500 <b>RDC1/60</b> 600 MFC Carcase</p>	<p><b>MIDI UNITS</b></p> <p><b>RMLU60</b> <b>RMA160</b> <b>RMD060</b> <b>RMOHS60</b></p> <p>H:1250mm CODE <b>RMLU60</b> WIDTH 600 <b>RMA160</b> 600</p> <p>H:1250mm CODE <b>RMD060</b> WIDTH 600 <b>RMOHS60</b> 600</p>	<p><b>LARDER</b></p> <p>H:1970mm CODE <b>RTLU30</b> WIDTH 300 <b>RTLU40</b> 400 <b>RTLU50</b> 500 <b>RTLU60</b> 600 <b>TLU80</b> 800 <b>TLU10</b> 1000</p> <p>H:2150mm CODE <b>RETLU30</b> WIDTH 300 <b>RETLU40</b> 400 <b>RETLU50</b> 500 <b>RETLU60</b> 600 <b>ETLU10</b> 1000</p>	<p><b>Drawer Larder</b></p> <p>H:1970mm CODE <b>TDLU80</b> WIDTH 800 <b>TDLU10</b> 1000 2x355mm drawers</p>
---	---	---	---	--	---

LARDER PULL-OUT LARDER INNER DRAWER LARDER DOUBLE OVEN SINGLE OVEN SINGLE OVEN + COMPACT

<p><b>Diagonal Walk-in Larder</b></p> <p>H:1970mm CODE <b>TDWIL1144</b> WIDTH 1144x1144 <b>ETDWIL1144*</b> 1144x1144</p>	<p><b>Diagonal</b></p> <p>H:1970mm CODE <b>TDCLU1003</b> WIDTH *H:2150mm 1003x1003 <b>ETDCLU1003*</b> 1003x1003</p>	<p><b>PULL-OUT LARDER</b></p> <p>H:1970mm CODE <b>RTISPOL30</b> WIDTH *H:2150mm 300 <b>RTKPOL30</b> 300 Standard Mechanism inc. <b>RETISPOL30*</b> 300 <b>RETKPOL30*</b> 300 Kesseböhmer Mechanism inc.</p>	<p><b>INNER DRAWER LARDER</b></p> <p>H:1970mm CODE <b>RTLID30</b> WIDTH 300 <b>RTLID40</b> 400 <b>RTLID50</b> 500 <b>RTLID60</b> 600</p> <p>H:2150mm CODE <b>RETLID30</b> WIDTH 300 <b>RETLID40</b> 400 <b>RETLID50</b> 500 <b>RETLID60</b> 600</p> <p>1 x Standard, 4 x Deep Drawers</p>	<p><b>DOUBLE OVEN</b></p> <p>H:1970mm CODE <b>RTOHD60</b> WIDTH *H:2150mm 600 <b>RTOHD60</b> 600 <b>RETOHD60*</b> 600</p>	<p><b>SINGLE OVEN</b></p> <p>H:1970mm CODE <b>RTOHS60</b> WIDTH *H:2150mm 600 <b>RTOHS60</b> 600 <b>RETOHS60*</b> 600</p>	<p><b>SINGLE OVEN + COMPACT</b></p> <p>H:1970mm CODE <b>RTOHC60</b> WIDTH *H:2150mm 600 <b>RETOHC60*</b> 600</p>
--	---	---	---	---	---	--

COMPACT TALL FRIDGE/FREEZER BOX WINE RACKS END SUPPORT PANELS CARCASE MFC PANELS

<p><b>COMPACT</b></p> <p>H:1970mm CODE <b>RTOHC60</b> WIDTH *H:2150mm 600 <b>RETOHC60*</b> 600</p>	<p><b>TALL FRIDGE/FREEZER</b></p> <p>H:1970mm CODE <b>RTFF1/60</b> WIDTH 600 <b>RTFF4/60*</b> 600 *Doors undrilled <b>RTFF1U/60#</b> 600 <b>RTFF4U/60#</b> 600 #For door on door appliances</p>	<p><b>BOX WINE RACKS</b></p> <p>H:2150mm CODE <b>RETF1/60</b> WIDTH 600 <b>RETF2/60</b> 600 <b>RETF1U/60#</b> 600 <b>RETF2U/60#</b> 600 #For door on door appliances</p>	<p><b>W:125mm / W:250mm*</b></p> <p>H:720mm CODE <b>RWR125-7</b> HEIGHT 720 <b>RWR250-7*</b> 720 <b>RWR125-9</b> 900 <b>RWR250-9*</b> 900 MFC Carcase</p>	<p><b>END SUPPORT PANELS</b></p> <p>H:900mm CODE <b>ESP</b> WIDTH 600 <b>900/700</b> 700 MFC Carcase</p>	<p><b>CARCASE MFC PANELS</b></p> <p>H:900mm CODE <b>1970/300</b> WXH 300x1970 <b>2150/560</b> 560x2150 <b>2350/660</b> 660x2350 <b>720/300</b> 300x720</p>
--	---	--	---	--	--

CORNICE / PELMET PLINTH PLANT ON END PANELS

<p><b>Curved Combi Section</b></p> <p>H:28mm CODE <b>CM/MG</b> LENGTH 3000 Gloss</p>	<p><b>Curved Plinth Section</b></p> <p>H:150mm CODE <b>PL</b> WIDTH 2940 Melamine [Carcase MFC] Gloss</p>	<p><b>Clear Sealing Strip</b></p> <p>H:150mm CODE <b>CPLS/MG</b> WIDTH 300x540 Gloss</p>	<p><b>18mm</b></p> <p>H:900mm CODE <b>2400/650/18MG</b> WXH 650x2400 <b>780/375/18MG</b> 375x780 <b>900/650/18MG</b> 650x900 <b>960/375/18MG</b> 375x960 Gloss</p>	<p><b>18mm Breakfast Bar Panel</b></p> <p>H:900mm CODE <b>900/2400/18MG</b> WXH 2400x900 Gloss</p>	<p><b>Corner Post (Spare)</b></p> <p>H:715mm CODE <b>CP/MG</b> WIDTH 60x60 Gloss</p>
--	---	--	--	--	--

FURNITURE ACCESSORIES INTEGRATED DOORS SPARE DOOR FITTINGS GENERAL ACCS.

<p><b>External Corner Post</b></p> <p>W:72mm CODE <b>ECP7/MG</b> HEIGHT 715 <b>ECP9/MG</b> 900 Gloss</p>	<p><b>External Radius Corner Post</b></p> <p>H:900mm CODE <b>ERCP/MG</b> WIDTH 80 Gloss</p>	<p><b>Radius End Post</b></p> <p>H:2400mm CODE <b>RP/MG</b> WXD 88x128 Gloss</p>	<p><b>Radius End Post Caps - Combi</b></p> <p>H:28mm CODE <b>RPCMC/MG</b> Gloss Use in conjunction with RP/MG</p>	<p><b>Undrilled</b></p> <p>CODE <b>INT4571</b> WXH 446x715 <b>INT6071</b> 596x715</p>	<p><b>Hinges [Hettich Soft Close]</b></p> <p>CODE <b>SCHINGE90</b> 90 degree [Pair] <b>SCHINGE170</b> 170 degree [Pair]</p>	<p><b>Stays [Blum Aventos]</b></p> <p>CODE <b>BLSTAYHKS*</b> HK-S stay [Pair] *Inlc mounting brackets]</p>	<p><b>GENERAL ACCS.</b></p> <p>CODE <b>STPWN</b> Set of 2 Door Strapping Plates <b>LEGSET</b> Set of 4 Adjustable legs <b>SACC</b> Pk 50 14mm Self Adhesive Cover Caps <b>PCC/MG</b> Painted Care Kit</p>
--	---	--	---	---	---	--	---

Note: Furniture codes beginning with the letter 'R' are assembled (rigid), by removing the 'R' the units are supplied unassembled (flat-pack).

J-HANDLE  
PRICE GROUP 4  
**METZ MATT**

Special sizes available  
contact us for further information

Colours Options [PG4]: Dust, Fog, Graphite, Light Grey and Savanna.



**HI-LINE BASE** **Pull-Out** **Curved Door** **Shallow Base [300mm deep]** **LOW BASE** **HI-LINE CORNER BASE**

H:720mm CODE	WIDTH	CODE	WIDTH
RBA15	150	R2BA60*	600
RBA26	260	RBA70#	700
RBA30	300	RBA80#	800
RBA35	350	RBA90#	900
RBA40	400	RBA10#	1000
RBA45	450	RBA12#	1200
RBA50	500	*No muntin [2x300 doors] # 2 x Doors	
RBA60	600		

H:720mm CODE	WIDTH	H:720mm CODE	WIDTH
RBISPO15	150	RCDRBA30	300x300
Standard Mechanism inc.			
RBKPO15	150		
Kesseböhmer Mechanism inc.			
RBKTP015	150		
Kesseböhmer Mechanism & Towel rail inc.			
Curved Return [300mm deep]			
H:720mm CODE	WIDTH		
RABA360	360		
H:720mm CODE	WIDTH		
RCRBA26	260		

H:720mm CODE	WIDTH	H:575mm CODE	WIDTH
RSBU30	300	RLBU30	300
RSBU35	350	RLBU40	400
RSBU40	400	RLBU45	450
RSBU45	450	RLBU50	500
RSBU50	500	RLBU60	600
RSBU60	600	RLBU80#	800
RSBU70#	700	RLBU90#	900
RSBU80#	800	RLBU10#	1000
RSBU90#	900	RLBU12#	1200
RSBU10#	1000	# 2 x Doors	

H:720mm CODE	WIDTH	CODE	WIDTH
RBAC830	800/300	RBAC950	900/500
RBAC80	800/400	RBAC960	900/600
RBAC845	800/450	RBAC140	1000/400
RBAC850	800/500	RBAC145	1000/450
RBAC860	800/600	RBAC10	1000/500
RBAC940	900/400	RBAC160	1000/600
RBAC945	900/450	RBAC12	1200/600

Inc. 60x60mm Corner Post & Blanking Panel

H:720mm CODE	WIDTH	H:720mm CODE	WIDTH
BAC90	900x900	CA90	900x900
Bi-fold hinge system Flatpack			

H:720mm CODE	WIDTH	CODE	WIDTH
RBD30	300	RBD80#	800
RBD40	400	RBD90#	900
RBD45	450	RBD10#	1000
RBD50	500	RBD12#	1200
RBD60	600	# 2 x Doors	

H:720mm CODE	WIDTH	H:720mm CODE	WIDTH
RBD80/1	800	RBD90/1	900
RBD10/1	1000		

H:720mm CODE	WIDTH	CODE	WIDTH
RBDF50	300	RBDF80#	450
RBDF60	400	RBDF90#	500
		RBDF10#	600
		RBDD10*#	800
		RBDD12*#	900
*One working drawer # 2 x Doors			

H:460mm CODE	WIDTH
RBSU60	600

To suit a sink height of 260mm

H:720mm CODE	WIDTH	CODE	WIDTH
RBDC830	800/300	RBDC140	1000/400
RBDC80	800/400	RBDC145	1000/450
RBDC845	800/450	RBDC10	1000/500
RBDC850	800/500	RBDC160	1000/600
RBDC860	800/600	RBDC12	1200/600

Inc. 60x60mm Corner Post & Blanking Panel

H:720mm CODE	WIDTH	H:720mm CODE	WIDTH
RBU060	600	RBUM60	600
175mm drawer & 110mm filler			

H:720mm CODE	WIDTH	H:720mm CODE	WIDTH
RBD250	500	RBD350	500
RBD260	600	RBD360	600
RBD280	800	RBD380	800
RBD290	900	RBD390	900
RBD210	1000	RBD310	1000

2x355mm Drawers

H:720mm CODE	WIDTH	H:720mm CODE	WIDTH
RBD350/175	500	RBD450/175	500
RBD360/175	600	RBD460/175	600

1x140mm, 2x283mm Drawers  
2x175mm, 1x355mm Drawers

H:720mm CODE	WIDTH	H:720mm CODE	WIDTH
RBD450	500	RBD530	300
RBD460	600	RBD540	400
RBD480	800	RBD545	450
RBD490	900	RBD550	500
RBD410	1000	RBD560	600

H:720mm CODE	WIDTH	H:720mm CODE	WIDTH
RBD450/175	500	RBD580	800
RBD460/175	600	RBD590	900
		RBD510	1000

3x140mm, 1x283mm Drawers  
4x175mm Drawers  
5x140mm Drawers

H:575mm CODE	WIDTH	CODE	WIDTH
RWU30-5	300	RWU90-5*#	900
RWU40-5	400	RWU10-5*#	1000
RWU45-5	450	*No muntin [2x300 doors] # 2 x Doors	
RWU50-5	500	Add 'X' to the end of the code for 350mm deep	
RWU60-5	600	Add 'X' to the end of the code for 350mm deep	
R2WU60-5*#	600		
RWU80-5*#	800		

H:575mm CODE	WIDTH	CODE	WIDTH
RCWD60-5	600x600	RAWU360-5	360
Add 'X' to the end of the code for 350mm deep [650x650]			

H:720mm CODE	WIDTH	CODE	WIDTH
RWU26-7	260	R2WU60-7*	600
RWU30-7	300	RWU70-7#	700
RWU35-7	350	RWU80-7#	800
RWU40-7	400	RWU90-7#	900
RWU45-7	450	RWU10-7#	1000
RWU50-7	500	*No muntin [2x300 doors] #2xDoors	
RWU60-7	600	Add 'X' to the end of the code for 350mm deep	

H:720mm CODE	WIDTH	H:720mm CODE	WIDTH
RCWD60-7	600x600	RCWL60-7	600x600
Add 'X' to the end of the code for 350mm deep [650x650]			

H:720mm CODE	WIDTH	H:720mm CODE	WIDTH
RWUC60-7	600	RAWU360-7	360
300 Door			
RWUC260-7	600	Add 'X' to the end of the code for 350mm deep	
260 Door			
Inc. 60x60mm Corner Post			
Add 'X' to the end of the code for 350mm deep			

H:720mm CODE	WIDTH	H:720mm CODE	WIDTH
RCDWU30-7	300x300	RMWU60-7	600
283mm flap, 110mm filler; Mechanism inc.			
Add 'X' to the end of the code for 350mm deep			

H:720mm CODE	WIDTH	H:720mm CODE	WIDTH
RBFWU60-7	600	RBFWU80-7	800
RBFWU90-7	900	RBFWU10-7	1000
Mechanism inc.			
Add 'X' to the end of the code for 350mm deep			

H:900mm CODE	WIDTH	CODE	WIDTH
RWU30-9	300	R2WU60-9*#	600
RWU40-9	400	RWU80-9#	800
RWU45-9	450	RWU90-9#	900
RWU50-9	500	RWU10-9#	1000
RWU60-9	600	*No muntin [2x300 doors] #2xDoors	
Add 'X' to the end of the code for 350mm deep			

H:900mm CODE	WIDTH
RCWD60-9	600x600

Add 'X' to the end of the code for 350mm deep [650x650]

Note: Furniture codes beginning with the letter 'R' are assembled (rigid), by removing the 'R' the units are supplied unassembled (flat-pack).

TALL WALL HORIZONTAL WALL OPEN WALL

**L' Shaped Corner**  
  
 H:900mm  
 CODE WIDTH  
**RCWL60-9** 600x600  
 Add 'X' to the end of the code for 350mm deep [650x650]

**Splayed**  
  
 H:900mm  
 CODE WIDTH  
**RAWU360-9** 360  
 Add 'X' to the end of the code for 350mm deep

**Boiler Wall**  
  
 H:900mm  
 CODE WIDTH  
**BWU6040-9** 600  
 400mm Deep  
 Flatpack

**H:290mm**  
 CODE WIDTH  
**RHWU5029** 500  
**RHWU6029** 600  
**RHWU8029** 800  
**RHWU9029** 900  
**RHWU1029** 1000

**H:360mm**  
 CODE WIDTH  
**RHWU5036** 500  
**RHWU6036** 600  
**RHWU8036** 800  
**RHWU9036** 900  
**RHWU1036** 1000  
 Add 'X' to the end of the code for 350mm deep

**H:290mm**  
 CODE WIDTH  
**RWOS50-2** 500  
**RWOS60-2** 600  
**RWOS80-2** 800  
**RWOS90-2** 900  
**RWOS10-2** 1000  
 MFC Carcase

**H:360mm**  
 CODE WIDTH  
**RWOS50-3** 500  
**RWOS60-3** 600  
**RWOS80-3** 800  
**RWOS90-3** 900  
**RWOS10-3** 1000  
 MFC Carcase

**H:575mm**  
 CODE WIDTH  
**RWOS30-5** 300  
**RWOS40-5** 400  
**RWOS45-5** 450  
**RWOS50-5** 500  
**RWOS60-5** 600  
**RWOS80-5** 800  
**RWOS90-5** 900  
**RWOS10-5** 1000  
 MFC Carcase

If 350mm deep carcase is required adjust code, e.g RWOS1035-2

If 350mm deep carcase is required adjust code, e.g RWOS1035-3

If 350mm deep carcase is required adjust code, e.g RWOS1035-5

**OPEN WALL**

**H:720mm**  
 CODE WIDTH  
**RWOS30-7** 300  
**RWOS40-7** 400  
**RWOS45-7** 450  
**RWOS50-7** 500  
**RWOS60-7** 600  
**RWOS80-7** 800  
**RWOS90-7** 900  
**RWOS10-7** 1000  
 MFC Carcase

**H:900mm**  
 CODE WIDTH  
**RWOS30-9** 300  
**RWOS40-9** 400  
**RWOS45-9** 450  
**RWOS50-9** 500  
**RWOS60-9** 600  
**RWOS80-9** 800  
**RWOS90-9** 900  
**RWOS10-9** 1000  
 MFC Carcase

**H:1210mm**  
 CODE WIDTH  
**RDC1/50** 500  
**RDC1/60** 600  
 MFC Carcase

If 350mm deep carcase is required adjust code, e.g RDC1/3550

If 350mm deep carcase is required adjust code, e.g RWOS1035-9

**MIDI UNITS**

**RMLU60**  
  
 H:1250mm  
 CODE WIDTH  
**RMLU60** 600  
**RMA160** 600

**RMD060**  
  
 H:1250mm  
 CODE WIDTH  
**RMD060** 600  
**RMOHS60** 600

**LARDER**

**H:1970mm**  
 CODE WIDTH  
**RTLU30** 300  
**RTLU40** 400  
**RTLU50** 500  
**RTLU60** 600  
**TLU80** 800  
**TLU10** 1000

**H:2150mm**  
 CODE WIDTH  
**RETLU30** 300  
**RETLU40** 400  
**RETLU50** 500  
**RETLU60** 600  
**ETLU80** 800  
**ETLU10** 1000

**Drawer Larder**  
  
 H:1970mm  
 CODE WIDTH  
**TDLU80** 800  
**TDLU10** 1000  
 2x35mm drawers

**LARDER**

**Diagonal Walk-in Larder**  
  
 H:1970mm \*H:2150mm  
 CODE WIDTH  
**TDWIL1144** 1144x1144  
**ETDWIL1144\*** 1144x1144

**Diagonal**  
  
 H:1970mm \*H:2150mm  
 CODE WIDTH  
**TDCLU1003** 1003x1003  
**ETDCLU1003\*** 1003x1003

**PULL-OUT LARDER**

**INNER DRAWER LARDER**

**DOUBLE OVEN**

**SINGLE OVEN**

**SINGLE OVEN + COMPACT**

**COMPACT**

**H:1970mm**  
 CODE WIDTH  
**RTOHC60** 600  
**RETOHC60\*** 600

**TALL FRIDGE/FREEZER**

**H:1970mm**  
 CODE WIDTH  
**RTFF1/60** 600  
**RTFF4/60\*** 600  
 \*Doors undrilled  
**RTFF1U/60#** 600  
**RTFF4U/60#** 600  
 #For door on door appliances

**H:2150mm**  
 CODE WIDTH  
**RTFF1/60** 600  
**RTFF2/60** 600  
**RTFF1U/60#** 600  
**RTFF2U/60#** 600  
 #For door on door appliances

**BOX WINE RACKS**

**W:125mm / W:250mm\***

**H:1970mm**  
 CODE HEIGHT  
**RWR125-7** 720  
**RWR250-7\*** 720  
**RWR125-9** 900  
**RWR250-9\*** 900  
 MFC Carcase

**H:2150mm**  
 CODE HEIGHT  
**RWR125-1210** 1210  
**RWR125-1970** 1970  
**RWR250-1970\*** 1970

If using as base order LEGSET

**END SUPPORT PANELS**

**H:900mm**  
 CODE WIDTH  
**ESP** 600  
**900/700** 700  
 MFC Carcase

**CARCASE MFC PANELS**

**CODE** **WIDTH** **WXH** **CODE** **WXH**  
**1970/300** 300x1970  
**2150/560** 560x2150  
**2350/660** 660x2350  
**720/300** 300x720  
**900/2000** 2000x900  
**900/300** 300x900  
 MFC Carcase

**UG/\*\*ET** 1000x22  
 \*Un-Glued 1m carcase edging

**CORNICE / PELMET**

**Curved Combi Section**  
  
 H:28mm  
 CODE LENGTH  
**CM/MM** 3000  
 Matt  
 Use in conjunction with CM/MM

**Curved Plinth Section**  
  
 H:150mm  
 CODE WIDTH  
**PL** 2940  
 Melamine [Carcase MFC]  
**PL/MM** 3000  
 Matt

**Clear Sealing Strip**  
  
 H:150mm  
 CODE WIDTH  
**CPLS/MM** 3000  
 Matt  
 Use in conjunction with PL/MM

**PLANT ON END PANELS**

**18mm**  
  
 CODE WXH  
**2400/650/18MM** 650x2400  
**780/375/18MM** 375x780  
**900/650/18MM** 650x900  
**960/375/18MM** 375x960  
 Matt

**18mm Breakfast Bar Panel**  
  
 CODE WXH  
**900/2400/18MM** 2400x900  
 Matt

**Corner Post [Spare]**  
  
 H:715mm  
 CODE WIDTH  
**CP/MM** 60x60  
 Matt

**FURNITURE ACCESSORIES**

**External Corner Post**  
  
 W:72mm  
 CODE HEIGHT  
**ECP7/MM** 715  
**ECP9/MM** 900  
 Matt

**External Radius Corner Post**  
  
 H:900mm  
 CODE WIDTH  
**ERCP/MM** 80  
 Matt

**Radius End Post**  
  
 H:2400mm  
 CODE WXD  
**RP/MM** 88x128  
 Matt

**Radius End Post Caps - Combi**  
  
 H:28mm  
 CODE  
**RPCMC/MM**  
 Matt  
 Use in conjunction with RP/MM

**INTEGRATED DOORS**

**Undrilled**  
  
 CODE WXH  
**INT4571** 446x715  
**INT6071** 596x715

**SPARE DOOR FITTINGS**

**Hinges [Hettich Soft Close]**  
 CODE  
**SCHINGE90** 90 degree [Pair]  
**SCHINGE170** 170 degree [Pair]

**Stays [Blum Aventos]**  
 CODE  
**BLSTAYHKS\*** HK-S stay [Pair]  
 \*[inc mounting brackets]

**GENERAL ACCS.**

**CODE**  
**STPWN** Set of 2 Door Strapping Plates  
**LEGSET** Set of 4 Adjustable legs  
**SACC** Pk 50 14mm Self Adhesive Cover Caps  
**PCC/MM** Painted Care Kit

Note: Furniture codes beginning with the letter 'R' are assembled (rigid), by removing the 'R' the units are supplied unassembled (flat-pack).

J-HANDLE  
PRICE GROUP 4  
**SARAYA GLOSS**

Special sizes available  
contact us for further information

Colours Options [PG4]: Ash and White.



**HI-LINE BASE**

Pull-Out		Curved Door		Curved Return [300mm deep]		Splayed	
H:720mm CODE <b>RBA15</b> 150 <b>RBA26</b> 260 <b>RBA30</b> 300 <b>RBA35</b> 350 <b>RBA40</b> 400 <b>RBA45</b> 450 <b>RBA50</b> 500 <b>RBA60</b> 600	WIDTH <b>R2BA60*</b> 600 <b>RBA70#</b> 700 <b>RBA80#</b> 800 <b>RBA90#</b> 900 <b>RBA10#</b> 1000 <b>RBA12#</b> 1200	CODE <b>RBISPO15</b> 150 Standard Mechanism inc. <b>RBKPO15</b> 150 Kesseböhmer Mechanism inc. <b>RBKTP015</b> 150 Kesseböhmer Mechanism & Towel rail inc.	WIDTH <b>RCDRBA30</b> 300x300	H:720mm CODE <b>RCRBA26</b> 260	WIDTH <b>RABA360</b> 360	H:720mm CODE <b>RSBU30</b> 300 <b>RSBU35</b> 350 <b>RSBU40</b> 400 <b>RSBU45</b> 450 <b>RSBU50</b> 500 <b>RSBU60</b> 600	WIDTH <b>RSBU70#</b> 700 <b>RSBU80#</b> 800 <b>RSBU90#</b> 900 <b>RSBU10#</b> 1000 # 2 x Doors

**LOW BASE**

**HI-LINE CORNER BASE**

**DRAWERLINE BASE**

Low Base		Hi-Line Corner Base		'L' Shaped		Diagonal		Drawerline Base		Single Top Drawer	
H:575mm CODE <b>RLBU30</b> 300 <b>RLBU40</b> 400 <b>RLBU45</b> 450 <b>RLBU50</b> 500 <b>RLBU60</b> 600 <b>RLBU80#</b> 800 <b>RLBU90#</b> 900 <b>RLBU10#</b> 1000 <b>RLBU12#</b> 1200	WIDTH <b>RBAC830</b> 800/300 <b>RBAC80</b> 800/400 <b>RBAC845</b> 800/450 <b>RBAC850</b> 800/500 <b>RBAC860</b> 800/600 <b>RBAC940</b> 900/400 <b>RBAC945</b> 900/450	CODE <b>RBAC950</b> 900/500 <b>RBAC960</b> 900/600 <b>RBAC140</b> 1000/400 <b>RBAC145</b> 1000/450 <b>RBAC10</b> 1000/500 <b>RBAC160</b> 1000/600 <b>RBAC12</b> 1200/600	WIDTH <b>BAC90</b> 900x900 Bi-fold hinge system Flatpack	H:720mm CODE <b>CDA90</b> 900x900	WIDTH <b>RBD30</b> 300 <b>RBD40</b> 400 <b>RBD45</b> 450 <b>RBD50</b> 500 <b>RBD60</b> 600	CODE <b>RBD80#</b> 800 <b>RBD90#</b> 900 <b>RBD10#</b> 1000 <b>RBD12#</b> 1200 # 2 x Doors	H:720mm CODE <b>RBD80/1</b> 800 <b>RBD90/1</b> 900 <b>RBD10/1</b> 1000				

Inc. 60x60mm Corner Post & Blanking Panel

**DRAWERLINE SINK BASE**

**CERAMIC SINK BASE**

**DRAWERLINE CORNER BASE**

**BUILT UNDER**

**2 DRAWER BASE**

**3 DRAWER BASE**

Drawerline Sink Base		Ceramic Sink Base		Drawerline Corner Base		Built Under		2 Drawer Base		3 Drawer Base	
H:720mm CODE <b>RBDF50</b> 500 <b>RBDF60</b> 600 <b>RBDF80#</b> 800 <b>RBDF90#</b> 900 <b>RBDF10#</b> 1000 <b>RBDD10*</b> 1000 <b>RBDD12*</b> 1200	WIDTH <b>RBSU60</b> 600 To suit a sink height of 260mm	H:720mm CODE <b>RBDC830</b> 800/300 <b>RBDC80</b> 800/400 <b>RBDC845</b> 800/450 <b>RBDC850</b> 800/500 <b>RBDC860</b> 800/600	WIDTH <b>RBDC140</b> 1000/400 <b>RBDC145</b> 1000/450 <b>RBDC10</b> 1000/500 <b>RBDC160</b> 1000/600 <b>RBDC12</b> 1200/600	H:720mm CODE <b>RBUD60</b> 600	WIDTH <b>RBUM60</b> 600 175mm drawer & 110mm filler	H:720mm CODE <b>RBD250</b> 500 <b>RBD260</b> 600 <b>RBD280</b> 800 <b>RBD290</b> 900 <b>RBD210</b> 1000	WIDTH <b>RBD350</b> 500 <b>RBD360</b> 600 <b>RBD380</b> 800 <b>RBD390</b> 900 <b>RBD310</b> 1000 2x355mm Drawers	H:720mm CODE <b>RBD350/175</b> 500 <b>RBD360/175</b> 600	WIDTH <b>RBD350/175</b> 500 <b>RBD360/175</b> 600 1x140mm, 2x283mm Drawers 2x175mm, 1x355mm Drawers		

Inc. 60x60mm Corner Post & Blanking Panel

**4 DRAWER BASE**

**5 DRAWER BASE**

**LOW WALL**

**Diagonal Corner**

**Splayed**

**MEDIUM WALL**

4 Drawer Base		5 Drawer Base		Low Wall		Diagonal Corner		Splayed		Medium Wall	
H:720mm CODE <b>RBD450</b> 500 <b>RBD460</b> 600 <b>RBD480</b> 800 <b>RBD490</b> 900 <b>RBD410</b> 1000 3x140mm, 1x283mm Drawers <b>RBD450/175</b> 500 <b>RBD460/175</b> 600 4x175mm Drawers	WIDTH <b>RBD530</b> 300 <b>RBD540</b> 400 <b>RBD545</b> 450 <b>RBD550</b> 500 <b>RBD560</b> 600 <b>RBD580</b> 800 <b>RBD590</b> 900 <b>RBD510</b> 1000 5x140mm Drawers	H:575mm CODE <b>RWU30-5</b> 300 <b>RWU40-5</b> 400 <b>RWU45-5</b> 450 <b>RWU50-5</b> 500 <b>RWU60-5</b> 600	WIDTH <b>R2WU60-5*</b> 600 <b>RWU80-5#</b> 800 <b>RWU90-5#</b> 900 <b>RWU10-5#</b> 1000 *No muntin [2 x 300 doors] # 2 x Doors	H:575mm CODE <b>RCWD60-5</b> 600x600	WIDTH <b>RAWU360-5</b> 360 Add 'X' to the end of the code for 350mm deep [650x650]	H:720mm CODE <b>RWU26-7</b> 260 <b>RWU30-7</b> 300 <b>RWU35-7</b> 350 <b>RWU40-7</b> 400 <b>RWU45-7</b> 450 <b>RWU50-7</b> 500 <b>RWU60-7</b> 600	WIDTH <b>R2WU60-7*</b> 600 <b>RWU70-7#</b> 700 <b>RWU80-7#</b> 800 <b>RWU90-7#</b> 900 <b>RWU10-7#</b> 1000 *No muntin [2x300 doors] #2x Doors				

Add 'X' to the end of the code for 350mm deep

**MEDIUM WALL**







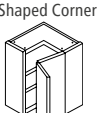
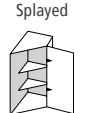
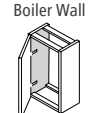
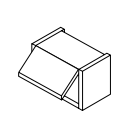



Glazed		Diagonal Corner		'L' Shaped Corner		Conventional Corner		Splayed		Curved Door		Microwave Wall		Bi-Fold	
H:720mm CODE <b>RWG50-7</b> 500 <b>RWG10-7</b> 1000 Add 'X' to the end of the code for 350mm deep	WIDTH <b>RCWD60-7</b> 600x600 Add 'X' to the end of the code for 350mm deep [650x650]	H:720mm CODE <b>RCWL60-7</b> 600x600 Bi-fold hinge system Add 'X' to the end of the code for 350mm deep [650x650]	WIDTH <b>RWUC260-7</b> 600 Inc. 60x60mm Corner Post Add 'X' to the end of the code for 350mm deep	H:720mm CODE <b>RAWU360-7</b> 360 Add 'X' to the end of the code for 350mm deep	WIDTH <b>RCDWU30-7</b> 300x300	H:720mm CODE <b>RMWU60-7</b> 600 283mm flap, 110mm filler; Mechanism inc. Add 'X' to the end of the code for 350mm deep	WIDTH <b>RBFWU50-7</b> 500 <b>RBFWU60-7</b> 600 <b>RBFWU80-7</b> 800 <b>RBFWU90-7</b> 900 <b>RBFWU10-7</b> 1000 Mechanism inc. Add 'X' to the end of the code for 350mm deep								









TALL WALL | HORIZONTAL WALL

 Diagonal Corner H:900mm CODE WIDTH CODE WIDTH <b>RWU30-9</b> 300 <b>R2WU60-9*#</b> 600 <b>RWU40-9</b> 400 <b>RWU80-9#</b> 800 <b>RWU45-9</b> 450 <b>RWU90-9#</b> 900 <b>RWU50-9</b> 500 <b>RWU10-9#</b> 1000 <b>RWU60-9</b> 600 *No muntin [2x300 doors] #2 x Doors Add 'X' to the end of the code for 350mm deep				 'L' Shaped Corner H:900mm CODE WIDTH CODE WIDTH <b>RCWD60-9</b> 600x600 <b>RCWL60-9</b> 600x600 Add 'X' to the end of the code for 350mm deep [650x650]				 Splayed H:900mm CODE WIDTH CODE WIDTH <b>RAWU360-9</b> 360 Add 'X' to the end of the code for 350mm deep				 Boiler Wall H:900mm CODE WIDTH CODE WIDTH <b>BWU6040-9</b> 600 400mm Deep Flatpack Add 'X' to the end of the code for 350mm deep				 HORIZONTAL WALL H:290mm CODE WIDTH CODE WIDTH <b>RHWU5029</b> 500 <b>RHWU5036</b> 500 <b>RHWU6029</b> 600 <b>RHWU6036</b> 600 <b>RHWU8029</b> 800 <b>RHWU8036</b> 800 <b>RHWU9029</b> 900 <b>RHWU9036</b> 900 <b>RHWU1029</b> 1000 <b>RHWU1036</b> 1000 Add 'X' to the end of the code for 350mm deep			
--	--	--	--	---	--	--	--	--	--	--	--	---	--	--	--	---	--	--	--







OPEN WALL | MIDI UNITS | LARDER

 H:290mm CODE WIDTH CODE WIDTH <b>RWOS50-2</b> 500 <b>RWOS60-2</b> 600 <b>RWOS80-2</b> 800 <b>RWOS90-2</b> 900 <b>RWOS10-2</b> 1000 MFC Carcase If 350mm deep carcase is required adjust code, e.g. RWOS1035-2				 H:360mm CODE WIDTH CODE WIDTH <b>RWOS50-3</b> 500 <b>RWOS60-3</b> 600 <b>RWOS80-3</b> 800 <b>RWOS90-3</b> 900 <b>RWOS10-3</b> 1000 MFC Carcase If 350mm deep carcase is required adjust code, e.g. RWOS1035-3				 H:575mm CODE WIDTH CODE WIDTH <b>RWOS30-5</b> 300 <b>RWOS40-5</b> 400 <b>RWOS45-5</b> 450 <b>RWOS50-5</b> 500 <b>RWOS60-5</b> 600 <b>RWOS80-5</b> 800 <b>RWOS90-5</b> 900 <b>RWOS10-5</b> 1000 MFC Carcase If 350mm deep carcase is required adjust code, e.g. RWOS1035-5				 H:720mm CODE WIDTH CODE WIDTH <b>RWOS30-7</b> 300 <b>RWOS40-7</b> 400 <b>RWOS45-7</b> 450 <b>RWOS50-7</b> 500 <b>RWOS60-7</b> 600 <b>RWOS80-7</b> 800 <b>RWOS90-7</b> 900 <b>RWOS10-7</b> 1000 MFC Carcase If 350mm deep carcase is required adjust code, e.g. RWOS1035-7				 H:900mm CODE WIDTH CODE WIDTH <b>RWOS30-9</b> 300 <b>RWOS40-9</b> 400 <b>RWOS45-9</b> 450 <b>RWOS50-9</b> 500 <b>RWOS60-9</b> 600 <b>RWOS80-9</b> 800 <b>RWOS90-9</b> 900 <b>RWOS10-9</b> 1000 MFC Carcase If 350mm deep carcase is required adjust code, e.g. RWOS1035-9				 H:1210mm CODE WIDTH CODE WIDTH <b>RDC1/50</b> 500 <b>RDC1/60</b> 600 MFC Carcase If 350mm deep carcase is required adjust code, e.g. RDC1/3550				<p>MIDI UNITS</p>  RMLU60  RMA160  RMD060  RMOHS60 H:1250mm CODE WIDTH <b>RMLU60</b> 600 <b>RMA160</b> 600 <b>RMD060</b> 600 <b>RMOHS60</b> 600		<p>LARDER</p>  H:1970mm CODE WIDTH <b>RTL30</b> 300 <b>RTLU40</b> 400 <b>RTLU50</b> 500 <b>RTLU60</b> 600 <b>TLU80</b> 800 <b>TLU10</b> 1000	
---	--	--	--	---	--	--	--	--	--	--	--	--	--	--	--	--	--	--	--	---	--	--	--	--	--	--	--







LARDER | PULL-OUT LARDER | INNER DRAWER LARDER

 H:2150mm CODE WIDTH CODE WIDTH <b>RETLU30</b> 300 <b>RETLU40</b> 400 <b>RETLU50</b> 500 <b>RETLU60</b> 600 <b>ETLU80</b> 800 <b>ETLU10</b> 1000				 H:1970mm CODE WIDTH CODE WIDTH <b>TDLU80</b> 800 <b>TDLU10</b> 1000 2x355 drawers				 H:1970mm *H:2150mm CODE WIDTH CODE WIDTH <b>TDWIL1144</b> 1144x1144 <b>ETDWIL1144*</b> 1144x1144				 H:1970mm *H:2150mm CODE WIDTH CODE WIDTH <b>TDCLU1003</b> 1003x1003 <b>ETDCLU1003*</b> 1003x1003				 H:1970mm *H:2150mm CODE WIDTH CODE WIDTH <b>RTISPOL30</b> 300 <b>RTKPOL30</b> 300 <b>RETISPOL30*</b> 300 <b>RETKPOL30*</b> 300 Standard Mechanism inc. Kesseböhmer Mechanism inc.				 H:1970mm CODE WIDTH CODE WIDTH <b>RTLID30</b> 300 <b>RTLID40</b> 400 <b>RTLID50</b> 500 <b>RTLID60</b> 600 1 x Standard, 4 x Deep drawers				 H:2150mm CODE WIDTH CODE WIDTH <b>RETLID30</b> 300 <b>RETLID40</b> 400 <b>RETLID50</b> 500 <b>RETLID60</b> 600			
--	--	--	--	---	--	--	--	---	--	--	--	---	--	--	--	---	--	--	--	---	--	--	--	---	--	--	--





DOUBLE OVEN | SINGLE OVEN | SINGLE OVEN + COMPACT | COMPACT | TALL FRIDGE/FREEZER | BOX WINE RACKS

 H:1970mm *H:2150mm CODE WIDTH CODE WIDTH <b>RTOHD60</b> 600 <b>RTOHD60</b> 600 <b>RETOHDD60*</b> 600				 H:1970mm *H:2150mm CODE WIDTH CODE WIDTH <b>RTOHS60</b> 600 <b>RTOHS60</b> 600 <b>RETOHS60*</b> 600				 H:1970mm *H:2150mm CODE WIDTH CODE WIDTH <b>RTOHC60</b> 600 <b>RETOHC60*</b> 600				 H:1970mm *H:2150mm CODE WIDTH CODE WIDTH <b>RTOHC60</b> 600 <b>RETOHC60*</b> 600				 H:1970mm CODE WIDTH CODE WIDTH <b>RTFF1/60</b> 600 <b>RTFF4/60*</b> 600 <b>RTFF4U/60#</b> 600 <b>RTFF4U/60#</b> 600 *Doors undrilled #For door on door appliances				 H:2150mm CODE WIDTH CODE WIDTH <b>RETFF1/60</b> 600 <b>RETFF2/60</b> 600 <b>RETFF1U/60#</b> 600 <b>RETFF2U/60#</b> 600 #For door on door appliances				 W:125mm / W:250mm* CODE HEIGHT CODE HEIGHT <b>RWR125-7</b> 720 <b>RWR250-7*</b> 720 <b>RWR125-9</b> 900 <b>RWR250-9*</b> 900 <b>RWR125-1210</b> 1210 <b>WR125-1970</b> 1970 <b>WR250-1970*</b> 1970 MFC Carcase If using as base order LEGSET			
---	--	--	--	---	--	--	--	---	--	--	--	---	--	--	--	--	--	--	--	---	--	--	--	---	--	--	--

END SUPPORT PANELS | CARCASE MFC PANELS | CORNICE / PELMET | PLINTH

 H:900mm CODE WIDTH CODE WIDTH <b>ESP</b> 600 <b>900/700</b> 700 MFC Carcase				 H:900mm CODE WxH CODE WxH <b>1970/300</b> 300x1970 <b>2150/560</b> 560x2150 <b>2350/660</b> 660x2350 <b>720/300</b> 300x720 <b>900/2000</b> 2000x900 <b>900/300</b> 300x900 MFC Carcase				 H:25mm CODE LENGTH CODE LENGTH <b>PCM/BG</b> 3000 Gloss				 Curved Combi Section H:25mm CODE WIDTH CODE WIDTH <b>CCMS/BG</b> 322x322 Gloss Use in conjunction with PCM/BG				 H:150mm CODE WIDTH CODE WIDTH <b>PL</b> 2940 MFC Carcase <b>PL/BG</b> 3000 Gloss				 Curved Plinth Section H:150mm CODE WxD CODE WxD <b>CPLS/BG</b> 275x535 Gloss Use in conjunction with PL/BG				 Clear Sealing Strip CODE WIDTH CODE WIDTH <b>PST</b> 3000			
---	--	--	--	---	--	--	--	--	--	--	--	--	--	--	--	--	--	--	--	---	--	--	--	---	--	--	--

PLANT ON END PANELS | FURNITURE ACCESSORIES | INTEGRATED DOORS | SPARE DOOR FITTINGS | GENERAL ACCS.

 22mm CODE WxH CODE WxH <b>2440/350/22BG</b> 350x2440 <b>2440/650/22BG</b> 650x2440 <b>900/650/22BG</b> 650x900 <b>910/1185/22BG</b> 1185x910 <b>950/350/22BG</b> 350x950 Gloss				 22mm Breakfast Bar Panel CODE WxH CODE WxH <b>900/2400/22BG</b> 2400x900 Gloss				 Corner Post [Spare] H:715mm CODE WIDTH CODE WIDTH <b>CP/BG</b> 60x60 Gloss				 External Corner Post H:715mm CODE WIDTH CODE WIDTH <b>ECP/BG</b> 53x53 Gloss				 Undrilled CODE WxH CODE WxH <b>INT6045</b> 596x450 <b>INT4571</b> 446x715 <b>INT6014</b> 596x140 <b>INT6057</b> 596x570 <b>INT6071</b> 596x715				<p>SPARE DOOR FITTINGS</p> <p>Hinges [Hettich Soft Close]                  CODE CODE  <b>SCHINGE90</b> 90 degree [Pair]  <b>SCHINGE170</b> 170 degree [Pair]</p> <p>Stays [Blum Aventos]                  CODE CODE  <b>BLSTAYHKS</b> HK-S stay [Pair]                  *[inc mounting brackets]</p> <p>GENERAL ACCS.                  CODE CODE  <b>STPWN</b> Set of 2 Door Strapping Plates  <b>LEGSET</b> Set of 4 Adjustable legs  <b>SACC</b> Pk 50 14mm Self Adhesive Cover Caps</p>			
---	--	--	--	---	--	--	--	--	--	--	--	--	--	--	--	--	--	--	--	--	--	--	--

Note: Furniture codes beginning with the letter 'R' are assembled (rigid), by removing the 'R' the units are supplied unassembled (flat-pack).



J-HANDLE

PRICE GROUP 4

# SARAYA MATT



Special sizes available  
contact us for further information

Colours Options (PG4): Ash, Cloud, Graphite and White.



## HI-LINE BASE

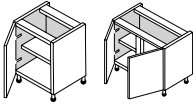

H:720mm	CODE	WIDTH
RBA15	150	
RBA26	260	
RBA30	300	
RBA35	350	
RBA40	400	
RBA45	450	
RBA50	500	
RBA60	600	

CODE	WIDTH
R2BA60*	600
RBA70#	700
RBA80#	800
RBA90#	900
RBA10#	1000
RBA12#	1200

\*No muntin [2x300 doors]  
# 2 x Doors

### Pull-Out



H:720mm	CODE	WIDTH
RBISPO15	150	

Standard Mechanism inc.  
Kesseböhmer Mechanism inc.  
RBKPO15 150  
RBKTP015 150  
Kesseböhmer Mechanism & Towel rail inc.

### Curved Door



H:720mm	CODE	WIDTH
RCDRBA30	300x300	

### Curved Return [300mm deep]



H:720mm	CODE	WIDTH
RCRBA26	260	

### Splayed



H:720mm	CODE	WIDTH
RABA360	360	

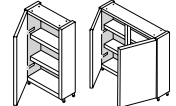

H:720mm	CODE	WIDTH	CODE	WIDTH
RSBU30	300		RSBU70#	700
RSBU35	350		RSBU80#	800
RSBU40	400		RSBU90#	900
RSBU45	450		RSBU10#	1000
RSBU50	500			# 2 x Doors
RSBU60	600			

## LOW BASE

## HI-LINE CORNER BASE

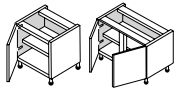

H:575mm	CODE	WIDTH
RLBU30	300	
RLBU40	400	
RLBU45	450	
RLBU50	500	
RLBU60	600	
RLBU80#	800	
RLBU90#	900	
RLBU10#	1000	
RLBU12#	1200	

# 2 x Doors



H:720mm	CODE	WIDTH	CODE	WIDTH
RBAC830	800/300		RBAC950	900/500
RBAC80	800/400		RBAC960	900/600
RBAC845	800/450		RBAC140	1000/400
RBAC850	800/500		RBAC145	1000/450
RBAC860	800/600		RBAC10	1000/500
RBAC940	900/400		RBAC160	1000/600
RBAC945	900/450		RBAC12	1200/600

Inc. 60x60mm Corner Post & Blanking Panel

### 'L' Shaped



H:720mm	CODE	WIDTH
BAC90	900x900	

Bi-fold hinge system  
Flatpack

### Diagonal



H:720mm	CODE	WIDTH
CDA90	900x900	

Flatpack

## DRAWERLINE BASE

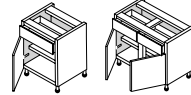

H:720mm	CODE	WIDTH	CODE	WIDTH
RBD30	300		RBD80#	800
RBD40	400		RBD90#	900
RBD45	450		RBD10#	1000
RBD50	500		RBD12#	1200
RBD60	600			# 2 x Doors

### Single Top Drawer



H:720mm	CODE	WIDTH	CODE	WIDTH
RBD80/1	800		RBD90/1	900
RBD10/1	1000			

## DRAWERLINE SINK BASE

## CERAMIC SINK BASE

## DRAWERLINE CORNER BASE

## BUILT UNDER

## 2 DRAWER BASE

## 3 DRAWER BASE

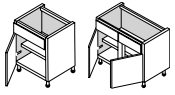

H:720mm	CODE	WIDTH
RBDF50	500	
RBDF60	600	
RBDF80#	800	
RBDF90#	900	
RBDF10#	1000	
RBDD10**	1000	
RBDD12**	1200	

\*One working drawer  
# 2 x Doors



H:460mm	CODE	WIDTH
RBSU60	600	

To suit a sink height of 260mm



H:720mm	CODE	WIDTH	CODE	WIDTH
RBDC830	800/300		RBDC140	1000/400
RBDC80	800/400		RBDC145	1000/450
RBDC845	800/450		RBDC10	1000/500
RBDC850	800/500		RBDC160	1000/600
RBDC860	800/600		RBDC12	1200/600

Inc. 60x60mm Corner Post & Blanking Panel

### Oven



H:720mm	CODE	WIDTH
RBUD060	600	

### Microwave



H:720mm	CODE	WIDTH
RBUM60	600	

175mm drawer & 110mm filler



H:720mm	CODE	WIDTH	CODE	WIDTH
RBD250	500		RBD350	500
RBD260	600		RBD360	600
RBD280	800		RBD380	800
RBD290	900		RBD390	900
RBD210	1000		RBD310	1000

2x355mm Drawers  
1x140mm, 2x283mm Drawers  
RBD350/175 500  
RBD360/175 600  
2x175mm, 1x355mm Drawers

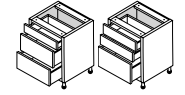

H:720mm	CODE	WIDTH	CODE	WIDTH
RBD350	500		RBD360	600
RBD380	800		RBD390	900
RBD310	1000			

1x140mm, 2x283mm Drawers  
RBD350/175 500  
RBD360/175 600  
2x175mm, 1x355mm Drawers

## 4 DRAWER BASE

## 5 DRAWER BASE

## LOW WALL

## Diagonal Corner

## Splayed

## MEDIUM WALL

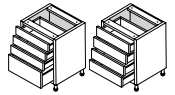

H:720mm	CODE	WIDTH
RBD450	500	
RBD460	600	
RBD480	800	
RBD490	900	
RBD410	1000	

3x140mm, 1x283mm Drawers  
RBD450/175 500  
RBD460/175 600  
4x175mm Drawers



H:720mm	CODE	WIDTH
RBD530	300	
RBD540	400	
RBD545	450	
RBD550	500	
RBD560	600	
RBD580	800	
RBD590	900	
RBD510	1000	

5x140mm Drawers

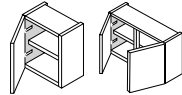

H:575mm	CODE	WIDTH	CODE	WIDTH
RWU30-5	300		R2WU60-5*	600
RWU40-5	400		RWU80-5#	800
RWU45-5	450		RWU90-5#	900
RWU50-5	500		RWU10-5#	1000
RWU60-5	600			*No muntin [2 x 300 doors]

# 2 x Doors  
Add 'X' to the end of the code for 350mm deep



H:575mm	CODE	WIDTH
RCWD60-5	600x600	

Add 'X' to the end of the code for 350mm deep [650x650]



H:575mm	CODE	WIDTH
RAWU360-5	360	

Add 'X' to the end of the code for 350mm deep

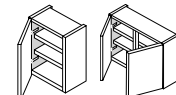

H:720mm	CODE	WIDTH	CODE	WIDTH
RWU26-7	260		R2WU60-7*	600
RWU30-7	300		RWU70-7#	700
RWU35-7	350		RWU80-7#	800
RWU40-7	400		RWU90-7#	900
RWU45-7	450		RWU10-7#	1000
RWU50-7	500			*No muntin [2x300 doors]
RWU60-7	600			# 2x Doors

Add 'X' to the end of the code for 350mm deep

## MEDIUM WALL

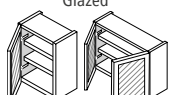

H:720mm	CODE	WIDTH
RWG50-7	500	
RWG10-7	1000	

Add 'X' to the end of the code for 350mm deep

### Diagonal Corner

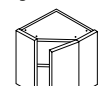

H:720mm	CODE	WIDTH
RCWD60-7	600x600	

Add 'X' to the end of the code for 350mm deep [650x650]

### 'L' Shaped Corner

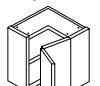

H:720mm	CODE	WIDTH
RCWL60-7	600x600	

Bi-fold hinge system  
Add 'X' to the end of the code for 350mm deep [650x650]

### Conventional Corner

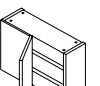

H:720mm	CODE	WIDTH
RWUC260-7	600	

Inc. 60x60mm Corner Post  
Add 'X' to the end of the code for 350mm deep

### Splayed



H:720mm	CODE	WIDTH
RAWU360-7	360	

Add 'X' to the end of the code for 350mm deep

### Curved Door



H:720mm	CODE	WIDTH
RCDWU30-7	300x300	

### Microwave Wall



H:720mm	CODE	WIDTH
RMWU60-7	600	

283mm flap, 110mm filler; Mechanism inc.  
Add 'X' to the end of the code for 350mm deep

### Bi-Fold



H:720mm	CODE	WIDTH	CODE	WIDTH
RBFWU50-7	500		RBFWU60-7	600
			RBFWU80-7	800
			RBFWU90-7	900
			RBFWU10-7	1000

Mechanism inc.  
Add 'X' to the end of the code for 350mm deep

TALL WALL

HORIZONTAL WALL

Diagonal Corner				'L' Shaped Corner				Splayed				Boiler Wall			
H:900mm CODE	WIDTH	CODE	WIDTH	H:900mm CODE	WIDTH	H:900mm CODE	WIDTH	H:900mm CODE	WIDTH	H:900mm CODE	WIDTH	H:290mm CODE	WIDTH	H:360mm CODE	WIDTH
<b>RWU30-9</b>	300	<b>R2WU60-9*</b>	600	<b>RCWD60-9</b>	600x600	<b>RCWL60-9</b>	600x600	<b>RAWU360-9</b>	360	<b>BWU6040-9</b>	600	<b>RHWU5029</b>	500	<b>RHWU5036</b>	500
<b>RWU40-9</b>	400	<b>RWU80-9*</b>	800	Add 'X' to the end of the code for 350mm deep [650x650]				Add 'X' to the end of the code for 350mm deep [650x650]				<b>RHWU6029</b>	600	<b>RHWU6036</b>	600
<b>RWU45-9</b>	450	<b>RWU90-9*</b>	900	Add 'X' to the end of the code for 350mm deep [650x650]				Add 'X' to the end of the code for 350mm deep [650x650]				<b>RHWU8029</b>	800	<b>RHWU8036</b>	800
<b>RWU50-9</b>	500	<b>RWU10-9*</b>	1000	Add 'X' to the end of the code for 350mm deep [650x650]				Add 'X' to the end of the code for 350mm deep [650x650]				<b>RHWU9029</b>	900	<b>RHWU9036</b>	900
<b>RWU60-9</b>	600	*No muntin [2x300 doors] #2 x Doors		Add 'X' to the end of the code for 350mm deep				Add 'X' to the end of the code for 350mm deep				<b>RHWU1029</b>	1000	<b>RHWU1036</b>	1000

OPEN WALL

H:290mm				H:360mm				H:575mm				H:720mm				H:900mm				H:1210mm			
CODE	WIDTH	CODE	WIDTH	CODE	WIDTH	CODE	WIDTH	CODE	WIDTH	CODE	WIDTH	CODE	WIDTH	CODE	WIDTH	CODE	WIDTH	CODE	WIDTH	CODE	WIDTH		
<b>RWOS50-2</b>	500	<b>RWOS50-3</b>	500	<b>RWOS30-5</b>	300	<b>RWOS30-7</b>	300	<b>RWOS30-9</b>	300	<b>RDC1/50</b>	500	<b>RDC1/60</b>	600	<b>RMD060</b>	600	<b>RMOHS60</b>	600	<b>RTL30</b>	300	<b>RTL40</b>	400		
<b>RWOS60-2</b>	600	<b>RWOS60-3</b>	600	<b>RWOS40-5</b>	400	<b>RWOS40-7</b>	400	<b>RWOS40-9</b>	400	MFC Carcase				<b>RTL50</b>	500	<b>TLU80</b>	800	<b>TLU10</b>	1000				
<b>RWOS80-2</b>	800	<b>RWOS80-3</b>	800	<b>RWOS45-5</b>	450	<b>RWOS45-7</b>	450	<b>RWOS45-9</b>	450	If 350mm deep carcase is required adjust code, e.g RDC1/3550				<b>RTL60</b>	600								
<b>RWOS90-2</b>	900	<b>RWOS90-3</b>	900	<b>RWOS50-5</b>	500	<b>RWOS50-7</b>	500	<b>RWOS50-9</b>	500														
<b>RWOS10-2</b>	1000	<b>RWOS10-3</b>	1000	<b>RWOS60-5</b>	600	<b>RWOS60-7</b>	600	<b>RWOS60-9</b>	600														
MFC Carcase				MFC Carcase				MFC Carcase				MFC Carcase				MFC Carcase				MFC Carcase			
If 350mm deep carcase is required adjust code, e.g RWOS1035-2				If 350mm deep carcase is required adjust code, e.g RWOS1035-3				If 350mm deep carcase is required adjust code, e.g RWOS1035-5				If 350mm deep carcase is required adjust code, e.g RWOS1035-7				If 350mm deep carcase is required adjust code, e.g RWOS1035-9							

LARDER

Drawer Larder				Diagonal Walk-in Larder				Diagonal				PULL-OUT LARDER				INNER DRAWER LARDER			
H:2150mm CODE	WIDTH	H:1970mm CODE	WIDTH	H:1970mm CODE	*H:2150mm WIDTH	H:1970mm CODE	*H:2150mm WIDTH	H:1970mm CODE	*H:2150mm WIDTH	H:1970mm CODE	*H:2150mm WIDTH	H:1970mm CODE	WIDTH	H:2150mm CODE	WIDTH				
<b>RETLU30</b>	300	<b>TDLU80</b>	800	<b>TDWIL1144</b>	1144x1144	<b>TDCLU1003</b>	1003x1003	<b>RTISPOL30</b>	300	<b>RTLID30</b>	300	<b>RETLID30</b>	300	<b>RETLID30</b>	300				
<b>RETLU40</b>	400	<b>TDLU10</b>	1000	<b>ETDWIL1144*</b>	1144x1144	<b>ETDCLU1003*</b>	1003x1003	<b>RTKPOL30</b>	300	<b>RTLID40</b>	400	<b>RETLID40</b>	400	<b>RETLID40</b>	400				
<b>RETLU50</b>	500	2x355 drawers						Standard Mechanism inc.				<b>RTLID50</b>	500	<b>RETLID50</b>	500				
<b>RETLU60</b>	600							Kesseböhmer Mechanism inc.				<b>RTLID60</b>	600	<b>RETLID60</b>	600				
<b>ETLU80</b>	800											1 x Standard, 4 x Deep drawers							
<b>ETLU10</b>	1000																		

DOUBLE OVEN

SINGLE OVEN

SINGLE OVEN + COMPACT

COMPACT

TALL FRIDGE/FREEZER

INNER DRAWER LARDER

BOX WINE RACKS

DOUBLE OVEN				SINGLE OVEN				SINGLE OVEN + COMPACT				COMPACT				TALL FRIDGE/FREEZER				INNER DRAWER LARDER				BOX WINE RACKS			
H:1970mm CODE	WIDTH	H:1970mm CODE	WIDTH	H:1970mm CODE	*H:2150mm WIDTH	H:1970mm CODE	*H:2150mm WIDTH	H:1970mm CODE	*H:2150mm WIDTH	H:1970mm CODE	*H:2150mm WIDTH	H:1970mm CODE	WIDTH	H:2150mm CODE	WIDTH	W:125mm / W:250mm*	CODE	HEIGHT	CODE	HEIGHT							
<b>RTOHD60</b>	600	<b>RTOHS60</b>	600	<b>RTOHC60</b>	600	<b>RETOHC60*</b>	600	<b>RTFF1/60</b>	600	<b>RETF1/60</b>	600	<b>RETF1/60</b>	600	<b>RETF1/60</b>	600	<b>RWR125-7</b>	720	<b>RWR125-7*</b>	720	<b>RWR125-9</b>	900						
<b>RTOHD60</b>	600	<b>RTOHS60</b>	600	<b>RETOHC60*</b>	600	<b>RETOHC60*</b>	600	<b>RTFF4/60*</b>	600	<b>RETF2/60</b>	600	<b>RETF2/60</b>	600	<b>RETF2/60</b>	600	<b>RWR250-9*</b>	900	<b>RWR250-9*</b>	900	<b>RWR125-1210</b>	1210						
<b>RETOHDD60*</b>	600	<b>RETOHS60*</b>	600					*Doors undrilled				<b>RETF1U/60#</b>	600	<b>RETF1U/60#</b>	600	<b>RWR125-1970</b>	1970	<b>WR250-1970*</b>	1970	<b>WR250-1970*</b>	1970						
												# For door on door appliances				*For door on door appliances				MFC Carcase							
																				If using as base order LEGSET							

END SUPPORT PANELS

CARCASE MFC PANELS

CORNICE / PELMET

PLINTH

END SUPPORT PANELS				CARCASE MFC PANELS				CORNICE / PELMET				PLINTH			
H:900mm CODE	WIDTH	CODE	WXH	CODE	WXH	CODE	LENGTH	CODE	WIDTH	CODE	WIDTH	CODE	WIDTH	CODE	WIDTH
<b>ESP</b>	600	<b>1970/300</b>	300x1970	<b>UG/**ET</b>	1000x22	<b>PCM/BM</b>	3000	<b>CCMS/BM</b>	322x322	<b>PL</b>	2940	<b>CPLS/BM</b>	275x535	<b>PST</b>	3000
<b>900/700</b>	700	<b>2150/560</b>	560x2150	*Un-Glued 1m carcase edging				Matt				Use in conjunction with PCM/BM			
MFC Carcase												MFC Carcase			
												Use in conjunction with PL/BM			

PLANT ON END PANELS

FURNITURE ACCESSORIES

INTEGRATED DOORS

SPARE DOOR FITTINGS

GENERAL ACCS.

PLANT ON END PANELS				FURNITURE ACCESSORIES				INTEGRATED DOORS				SPARE DOOR FITTINGS				GENERAL ACCS.							
CODE	WXH	CODE	WXH	H:715mm CODE	WIDTH	H:715mm CODE	WIDTH	CODE	WXH	CODE	WXH	CODE	WXH	CODE	WXH	CODE	DESCRIPTION	CODE	DESCRIPTION				
<b>2440/350/22BM</b>	350x2440	<b>900/2400/22BM</b>	2400x900	<b>CP/BM</b>	60x60	<b>ECP/BM</b>	53x53	<b>INT6045</b>	596x450	<b>SCHINGE90</b>	90 degree [Pair]	<b>BLSTAYHKS</b>	Set of 2	<b>STPWN</b>	Set of 2	<b>HK-S stay [Pair]</b>	Door Strapping Plates	<b>LEGSET</b>	Set of 4				
<b>2440/650/22BM</b>	650x2440	Matt		Matt				<b>INT6014</b>	596x140	<b>SCHINGE170</b>	170 degree [Pair]	* [Inc mounting brackets]				<b>Adjustable legs</b>		<b>SACC</b>	Pk 50				
<b>900/650/22BM</b>	650x900							<b>INT6057</b>	596x570					<b>14mm Self Adhesive Cover Caps</b>									
<b>910/1185/22BM</b>	1185x910							<b>INT6071</b>	596x715														
<b>950/350/22BM</b>	350x950																						
Matt																							





# Slab

Transform your space with our Slab kitchen collection - a modern embodiment of simplicity and style. The sleek, plain slab doors seamlessly integrate into a contemporary setting, offering an understated charm.

Choose between the high-gloss finish for a sophisticated sheen or the painted matt kitchen for a laid-back feel.



SLAB  
PRICE GROUP 2  
**BRAVA**

Special sizes available  
contact us for further information

Colours Options [PG2]: Concrete, Dark Oak and Rustic Iron



**HI-LINE BASE**

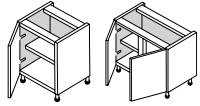

**Pull-Out**

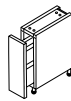

**Splayed**

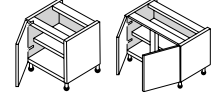
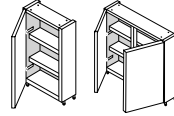
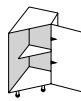

H:720mm CODE	WIDTH	CODE	WIDTH
RBA15	150	R2BA60*	600
RBA30	300	RBA70#	700
RBA35	350	RBA80#	800
RBA40	400	RBA90#	900
RBA45	450	RBA10#	1000
RBA50	500	RBA12#	1200
RBA60	600		

\*No muntin [2x300 doors]  
# 2 x Doors

H:720mm CODE	WIDTH	H:720mm CODE	WIDTH
RBISPO15	150	RBKPO15	150
		Standard Mechanism inc.	
		RBKPO15	150
		Kesseböhmer Mechanism inc.	
		RBKTP015	150
		Kesseböhmer Mechanism & Towel rail inc.	

H:720mm CODE	WIDTH
RABA360	360

H:720mm CODE	WIDTH	H:720mm CODE	WIDTH
RSBU30	300	RSBU70#	700
RSBU35	350	RSBU80#	800
RSBU40	400	RSBU90#	900
RSBU45	450	RSBU10#	1000
RSBU50	500		# 2 x Doors
RSBU60	600		

H:575mm CODE	WIDTH	H:575mm CODE	WIDTH
RLBU30	300	RLBU80#	800
RLBU40	400	RLBU90#	900
RLBU45	450	RLBU10#	1000
RLBU50	500	RLBU12#	1200
RLBU60	600		# 2 x Doors

**HI-LINE CORNER BASE**



**'L' Shaped**

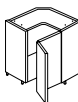

**Diagonal**

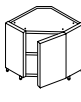

H:720mm CODE	WIDTH	H:720mm CODE	WIDTH
RBAC830	800/300	RBAC950	900/500
RBAC80	800/400	RBAC960	900/600
RBAC845	800/450	RBAC140	1000/400
RBAC850	800/500	RBAC145	1000/450
RBAC860	800/600	RBAC10	1000/500
RBAC940	900/400	RBAC160	1000/600
RBAC945	900/450	RBAC12	1200/600

H:720mm CODE	WIDTH	H:720mm CODE	WIDTH
BAC90	900x900		
		Bi-fold hinge system	
		Flatpack	

H:720mm CODE	WIDTH
CDA90	900x900
	Flatpack

**DRAWERLINE BASE**

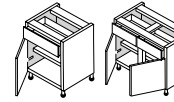

**Single Top Drawer**

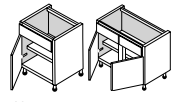

H:720mm CODE	WIDTH	H:720mm CODE	WIDTH
RBD30	300	RBD80#	800
RBD40	400	RBD90#	900
RBD45	450	RBD10#	1000
RBD50	500	RBD12#	1200
RBD60	600		# 2 x Doors

H:720mm CODE	WIDTH	H:720mm CODE	WIDTH
RBD80/1	800	RBDF50	500
RBD90/1	900	RBDF60	600
RBD10/1	1000	RBDF80#	800
		RBDF90#	900
		RBDF10#	1000
		RBDD10*#	1000
		RBDD12*#	1200

\*One working drawer  
# 2 x Doors

Includes Corner Post & Blanking Panel

**CERAMIC SINK BASE**

**DRAWERLINE CORNER BASE**

**BUILT UNDER**

**2 DRAWER BASE**

**3 DRAWER BASE**

**4 DRAWER BASE**

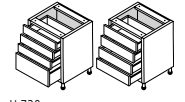
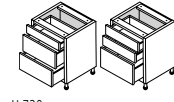
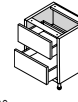
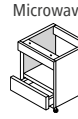
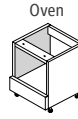

H:460mm CODE	WIDTH
RBSU60	600

To suit a sink height of 260mm

H:720mm CODE	WIDTH	H:720mm CODE	WIDTH
RBDC830	800/300	RBDC140	1000/400
RBDC80	800/400	RBDC145	1000/450
RBDC845	800/450	RBDC10	1000/500
RBDC850	800/500	RBDC160	1000/600
RBDC860	800/600	RBDC12	1200/600

Includes Corner Post & Blanking Panel

H:720mm CODE	WIDTH
RBU060	600

H:720mm CODE	WIDTH
RBUM60	600
	175mm drawer & 110mm filler

H:720mm CODE	WIDTH
RBD250	500
RBD260	600
RBD280	800
RBD290	900
RBD210	1000

2x355mm Drawers

H:720mm CODE	WIDTH
RBD350	500
RBD360	600
RBD380	800
RBD390	900
RBD310	1000

1x140mm, 2x283mm Drawers

H:720mm CODE	WIDTH
RBD450	500
RBD460	600
RBD480	800
RBD490	900
RBD410	1000

3x140mm, 1x283mm Drawers

**5 DRAWER BASE**

**LOW WALL**

**Diagonal Corner**

**Splayed**

**MEDIUM WALL**

**Diagonal Corner**

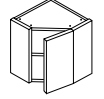
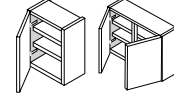
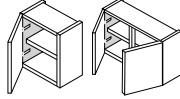

H:720mm CODE	WIDTH
RBD530	300
RBD540	400
RBD545	450
RBD550	500
RBD560	600
RBD580	800
RBD590	900
RBD510	1000

5x140mm Drawers

H:575mm CODE	WIDTH	H:575mm CODE	WIDTH
RWU30-5	300	R2WU60-5*	600
RWU40-5	400	RWU80-5#	800
RWU45-5	450	RWU90-5#	900
RWU50-5	500	RWU10-5#	1000
RWU60-5	600		*No muntin [2 x 300 doors] # 2 x Doors

Add 'X' to the end of the code for 350mm deep

H:575mm CODE	WIDTH
RCWD60-5	600x600
	Add 'X' to the end of the code for 350mm deep [650x650]

H:575mm CODE	WIDTH
RAWU360-5	360
	Add 'X' to the end of the code for 350mm deep

H:720mm CODE	WIDTH	H:720mm CODE	WIDTH
RWU30-7	300	R2WU60-7*	600
RWU35-7	350	RWU70-7#	700
RWU40-7	400	RWU80-7#	800
RWU45-7	450	RWU90-7#	900
RWU50-7	500	RWU10-7#	1000
RWU60-7	600		*No muntin [2x300 doors] #2x Doors

Add 'X' to the end of the code for 350mm deep

**MEDIUM WALL**

**'L' Shaped Corner**

**Conventional Corner**

**Splayed**

**Microwave Wall**

**Bi-Fold**

**TALL WALL**

**Diagonal Corner**

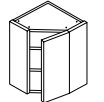
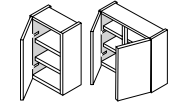
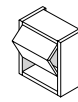
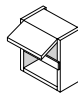
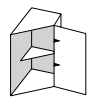
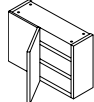
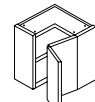

H:720mm CODE	WIDTH
RCWL60-7	600x600
	Bi-fold hinge system
	Add 'X' to the end of the code for 350mm deep [650x650]

H:720mm CODE	WIDTH
RWUC260-7	600
	Includes Corner Post
	Add 'X' to the end of the code for 350mm deep

H:720mm CODE	WIDTH
RAWU360-7	360
	Add 'X' to the end of the code for 350mm deep

H:720mm CODE	WIDTH
RMWU60-7	600
	283mm flap, 110mm filler; Mechanism inc.
	Add 'X' to the end of the code for 350mm deep

H:720mm CODE	WIDTH
RBFWU50-7	500
RBFWU60-7	600
RBFWU80-7	800
RBFWU90-7	900
RBFWU10-7	1000
	Mechanism inc.
	Add 'X' to the end of the code for 350mm deep

H:900mm CODE	WIDTH	H:900mm CODE	WIDTH
RWU30-9	300	R2WU60-9*#	600
RWU40-9	400	RWU80-9#	800
RWU45-9	450	RWU90-9#	900
RWU50-9	500	RWU10-9#	1000
RWU60-9	600		*No muntin [2x300 doors] #2 x Doors

Add 'X' to the end of the code for 350mm deep

TALL WALL HORIZONTAL WALL OPEN WALL

'L' Shaped Corner		Splayed		Boiler Wall		H:290mm		H:360mm		H:575mm	
CODE	WIDTH	CODE	WIDTH	CODE	WIDTH	CODE	WIDTH	CODE	WIDTH	CODE	WIDTH
<b>RCWL60-9</b>	600x600	<b>RAWU360-9</b>	360	<b>BWU6040-9</b>	600	<b>RHWU5029</b>	500	<b>RHWU5036</b>	500	<b>RWOS50-2</b>	500
Add 'X' to the end of the code for 350mm deep [650x650]			Add 'X' to the end of the code for 350mm deep			400mm Deep Flatpack			MFC Carcase		
<b>RWOS60-2</b>	600	<b>RWOS60-3</b>	600	<b>RWOS80-2</b>	800	<b>RWOS80-3</b>	800	<b>RWOS90-2</b>	900	<b>RWOS90-3</b>	900
<b>RWOS10-2</b>	1000	MFC Carcase		MFC Carcase		MFC Carcase		MFC Carcase		MFC Carcase	

Add 'X' to the end of the code for 350mm deep

If 350mm deep carcase is required adjust code, e.g RWOS1035-2

If 350mm deep carcase is required adjust code, e.g RWOS1035-3

If 350mm deep carcase is required adjust code, e.g RWOS1035-5

OPEN WALL MIDI UNITS LARDER

H:720mm		H:900mm		H:1210mm		H:1250mm		H:1970mm		H:2150mm	
CODE	WIDTH	CODE	WIDTH	CODE	WIDTH	CODE	WIDTH	CODE	WIDTH	CODE	WIDTH
<b>RWOS30-7</b>	300	<b>RWOS30-9</b>	300	<b>RDC1/50</b>	500	<b>RMLU60</b>	600	<b>RMD060</b>	600	<b>RTLU30</b>	300
<b>RWOS40-7</b>	400	<b>RWOS40-9</b>	400	<b>RDC1/60</b>	600	<b>RMA160</b>	600	<b>RMOH560</b>	600	<b>RTLU40</b>	400
<b>RWOS45-7</b>	450	<b>RWOS45-9</b>	450	MFC Carcase		MFC Carcase		MFC Carcase		<b>RTLU50</b>	500
<b>RWOS50-7</b>	500	<b>RWOS50-9</b>	500	If 350mm deep carcase is required adjust code, e.g RDC1/3550		If 350mm deep carcase is required adjust code, e.g RDC1/3550		If 350mm deep carcase is required adjust code, e.g RDC1/3550		<b>RTLU60</b>	600
<b>RWOS60-7</b>	600	<b>RWOS60-9</b>	600	MFC Carcase		MFC Carcase		MFC Carcase		<b>TLU80</b>	800
<b>RWOS80-7</b>	800	<b>RWOS80-9</b>	800	MFC Carcase		MFC Carcase		MFC Carcase		<b>ETLU80</b>	800
<b>RWOS90-7</b>	900	<b>RWOS90-9</b>	900	MFC Carcase		MFC Carcase		MFC Carcase		<b>ETLU10</b>	1000
<b>RWOS10-7</b>	1000	<b>RWOS10-9</b>	1000	MFC Carcase		MFC Carcase		MFC Carcase			

LARDER PULL-OUT LARDER INNER DRAWER LARDER

Single Door		Drawer Larder		'L' Shaped		Diagonal Walk-in Larder		Diagonal		H:1970mm		H:1970mm	
CODE	WIDTH	CODE	WIDTH	CODE	WIDTH	CODE	WIDTH	CODE	WIDTH	CODE	WIDTH	CODE	WIDTH
<b>RTLUSD50</b>	500	<b>TDLU80</b>	800	<b>TCLU98</b>	985x985	<b>TDWIL1144</b>	1144x1144	<b>TDCLU1003</b>	1003x1003	<b>RTISPOL30</b>	300	<b>RTLID30</b>	300
<b>RTLUSD60</b>	600	<b>TDLU10</b>	1000	<b>ETCLU98*</b>	985x985	<b>ETDWIL1144*</b>	1144x1144	<b>ETDCLU1003*</b>	1003x1003	<b>RTKPOL30</b>	300	<b>RTLID40</b>	400
		2x355 drawers		Bi-fold hinge system						Standard Mechanism inc.		<b>RTLID50</b>	500
										<b>RETISPOL30*</b>		<b>RTLID60</b>	600
										<b>RETSPOL30*</b>		<b>RTLID50/60*</b>	600
										<b>RETSPOL30*</b>		<b>RTLID60/60*</b>	600
										Kesseböhmer Mechanism		1 x Standard, 4 x Deep drawers	

INNER DRAWER LARDER DOUBLE OVEN SINGLE OVEN SINGLE OVEN + COMPACT COMPACT TALL FRIDGE/FREEZER

H:2150mm		H:1970mm		H:1970mm		H:1970mm		H:1970mm		H:1970mm		H:2150mm	
CODE	WIDTH	CODE	WIDTH	CODE	WIDTH	CODE	WIDTH	CODE	WIDTH	CODE	WIDTH	CODE	WIDTH
<b>RETLD30</b>	300	<b>RTOHD60</b>	600	<b>RTOHS60</b>	600	<b>RTOHSC60</b>	600	<b>RTOHC60</b>	600	<b>RTFF1/60</b>	600	<b>RETFF1/60</b>	600
<b>RETLD40</b>	400	<b>RTOHDD60</b>	600	<b>RTOHS60*</b>	600	<b>RETOHSC60*</b>	600	<b>RETOHC60*</b>	600	<b>RTFF4/60*</b>	600	<b>RETFF2/60</b>	600
<b>RETLD50</b>	500	<b>RETOHDD60*</b>	600	<b>RETOHS60*</b>	600					<b>RTFF1U/60#</b>	600	<b>RETFF1U/60#</b>	600
<b>RETLD60</b>	600									<b>RTFF4U/60#</b>	600	<b>RETFF2U/60#</b>	600
1 x Standard, 4 x Deep drawers										*Doors undrilled		*For door on door appliances	
										*For door on door appliances			

BOX WINE RACKS END SUPPORT PANELS CARCASE MFC PANELS CORNICE / PELMET PLINTH

W:125mm / W:250mm*		H:900mm		H:900mm		H:22mm		H:150mm	
CODE	HEIGHT	CODE	HEIGHT	CODE	WIDTH	CODE	LENGTH	CODE	WIDTH
<b>RWR125-7</b>	720	<b>RWR125-1210</b>	1210	<b>ESP</b>	600	<b>1970/300</b>	300x1970	<b>UG/*ET</b>	1000x22
<b>RWR250-7*</b>	720	<b>WR125-1970</b>	1970	<b>900/700</b>	700	<b>2150/560</b>	560x2150	*Un-Glued 1m carcase edge	
<b>RWR125-9</b>	900	<b>WR250-1970*</b>	1970	MFC Carcase		<b>2350/660</b>	660x2350	<b>SET/B</b>	5000x29
<b>RWR250-9*</b>	900	MFC Carcase		If using as base order LEGSET		<b>720/300</b>	300x720	Un-glued 5M roll - Door Finish	
						<b>900/2000</b>	2000x900		
						<b>900/300</b>	300x900		
						MFC Carcase			

PLANT ON END PANELS FURNITURE ACCESSORIES INTEGRATED DOORS SPARE DOOR FITTINGS GENERAL ACCS.

22mm		22mm Breakfast Bar Panel		Corner Post [Spare]		Undrilled		Hinges [Hettich Soft Close]		Stays [Blum Aventos]		GENERAL ACCS.	
CODE	WXH	CODE	WXH	CODE	WIDTH	CODE	WXH	CODE	LENGTH	CODE	WIDTH	CODE	DESCRIPTION
<b>2400/350/22B</b>	350x2440	<b>900/2400/22B</b>	2400x900	<b>CP/B</b>	146	<b>INT4571</b>	446x715	<b>SCHINGE90</b>	3000	<b>BLSTAYHK5</b>	2940	<b>STPWN</b>	Set of 2
<b>2400/650/22B</b>	650x2440	Door Finish		Door Finish		<b>INT6071</b>	596x715	<b>SCHINGE170</b>	170 degree [Pair]	HK-S stay [Pair]		<b>LEGSET</b>	Set of 4
<b>900/650/22B</b>	650x900							170 degree [Pair]		*[inc mounting brackets]		<b>SACC</b>	Pk 50
<b>900/910/22B</b>	910x900											<b>14mm Self Adhesive Cover Caps</b>	
<b>910/1170/22B</b>	1170x910												
<b>950/350/22B</b>	350x950												
Door Finish													

Note: Furniture codes beginning with the letter 'R' are assembled (rigid), by removing the 'R' the units are supplied unassembled (flat-pack).

SLAB

PRICE GROUP 2  
**COMO**

*Special sizes available*  
contact us for further information

Colours Options [PG2]: Cashmere, Dust Grey, Fern, Grey, Indigo, Oyster, Sage and White.



HI-LINE BASE

LOW BASE

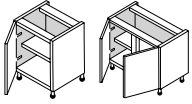

H:720mm CODE	WIDTH	CODE	WIDTH
RBA15	150	R2BA60*	600
RBA25	250	RBA70#	700
RBA30	300	RBA80#	800
RBA35	350	RBA90#	900
RBA40	400	RBA10#	1000
RBA45	450	RBA12#	1200
RBA50	500	*No muntin [2x300 doors]	
RBA60	600	# 2 x Doors	

Pull-Out

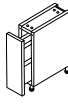

H:720mm CODE	WIDTH	H:720mm CODE	WIDTH
RBISPO15	150	RABA360	360

Standard Mechanism inc.  
Kesseböhmer Mechanism inc.  
Kesseböhmer Mechanism & Towel rail inc.

Splayed

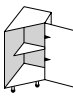

H:720mm CODE	WIDTH
RABA360	360

Shallow Base [300mm deep]

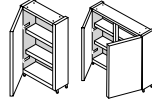

H:720mm CODE	WIDTH	CODE	WIDTH
RSBU30	300	RSBU70#	700
RSBU35	350	RSBU80#	800
RSBU40	400	RSBU90#	900
RSBU45	450	RSBU10#	1000
RSBU50	500	# 2 x Doors	
RSBU60	600		

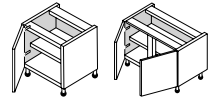

H:575mm CODE	WIDTH	CODE	WIDTH
RLBU30	300	RLBU80#	800
RLBU40	400	RLBU90#	900
RLBU45	450	RLBU10#	1000
RLBU50	500	RLBU12#	1200
RLBU60	600	# 2 x Doors	

HI-LINE CORNER BASE



H:720mm CODE	WIDTH	CODE	WIDTH
RBAC830	800/300	RBAC950	900/500
RBAC80	800/400	RBAC960	900/600
RBAC845	800/450	RBAC140	1000/400
RBAC850	800/500	RBAC145	1000/450
RBAC860	800/600	RBAC10	1000/500
RBAC940	900/400	RBAC160	1000/600
RBAC945	900/450	RBAC12	1200/600

Inc. Corner Post & Blanking Panel

'L' Shaped

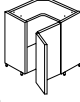

H:720mm CODE	WIDTH
BAC90	900x900

Bi-fold hinge system  
Flatpack

Diagonal

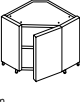

H:720mm CODE	WIDTH
CDA90	900x900

Flatpack

DRAWERLINE BASE

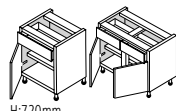

H:720mm CODE	WIDTH	H:720mm CODE	WIDTH
RBD30	300	RBD80/1	800
RBD40	400	RBD90/1	900
RBD45	450	RBD10/1	1000
RBD50	500		
RBD60	600		
RBD80#	800		
RBD90#	900		
RBD10#	1000		
RBD12#	1200		

# 2 x Doors

Single Top Drawer

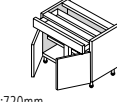

H:720mm CODE	WIDTH
RBD80/1	800
RBD90/1	900
RBD10/1	1000

DRAWERLINE SINK BASE

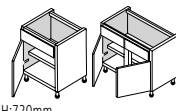

H:720mm CODE	WIDTH
RBDF50	500
RBDF60	600
RBDF80#	800
RBDF90#	900
RBDF10#	1000
RBDD10*#	1000
RBDD12*#	1200

\*One working drawer  
# 2 x Doors

CERAMIC SINK BASE



H:460mm CODE	WIDTH
RBSU60	600

To suit a sink height of 260mm

DRAWERLINE CORNER BASE



H:720mm CODE	WIDTH	CODE	WIDTH
RBDC830	800/300	RBDC140	1000/400
RBDC80	800/400	RBDC145	1000/450
RBDC845	800/450	RBDC10	1000/500
RBDC850	800/500	RBDC160	1000/600
RBDC860	800/600	RBDC12	1200/600

Inc. Corner Post & Blanking Panel

BUILT UNDER

Oven



H:720mm CODE	WIDTH
RBU060	600

Microwave



H:720mm CODE	WIDTH
RBUM60	600

175mm drawer & 110mm filler

2 DRAWER BASE



H:720mm CODE	WIDTH
RBD250	500
RBD260	600
RBD280	800
RBD290	900
RBD210	1000

2x355mm Drawers

3 DRAWER BASE

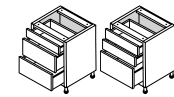

H:720mm CODE	WIDTH
RBD350	500
RBD360	600
RBD380	800
RBD390	900
RBD310	1000

1x140mm, 2x283mm Drawers

4 DRAWER BASE

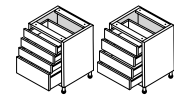

H:720mm CODE	WIDTH
RBD450	500
RBD460	600
RBD480	800
RBD490	900
RBD410	1000

3x140mm, 1x283mm Drawers

5 DRAWER BASE



H:720mm CODE	WIDTH
RBD530	300
RBD540	400
RBD545	450
RBD550	500
RBD560	600
RBD580	800
RBD590	900
RBD510	1000

5x140mm Drawers

LOW WALL

MEDIUM WALL

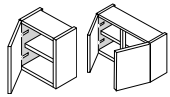

H:575mm CODE	WIDTH	CODE	WIDTH
RWU30-5	300	R2WU60-5*#	600
RWU40-5	400	RWU80-5#	800
RWU45-5	450	RWU90-5#	900
RWU50-5	500	RWU10-5#	1000
RWU60-5	600	*No muntin # 2 x Doors	

Add 'X' to the end of the code for 350mm deep

Diagonal Corner



H:575mm CODE	WIDTH
RCWD60-5	600x600

Add 'X' to the end of the code for 350mm deep [650x650]

Splayed



H:575mm CODE	WIDTH
RAWU360-5	360

Add 'X' to the end of the code for 350mm deep

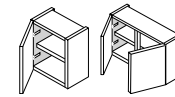

H:720mm CODE	WIDTH	CODE	WIDTH
RWU25-7	250	R2WU60-7*	600
RWU30-7	300	RWU70-7#	700
RWU35-7	350	RWU80-7#	800
RWU40-7	400	RWU90-7#	900
RWU45-7	450	RWU10-7#	1000
RWU50-7	500	*No muntin [2x300 doors]	
RWU60-7	600	# 2 x Doors	

Add 'X' to the end of the code for 350mm deep

Glazed Door

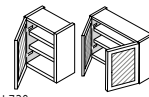

H:720mm CODE	WIDTH
RWG50-7	500
RWG10-7	1000

Add 'X' to the end of the code for 350mm deep

Diagonal Corner



H:720mm CODE	WIDTH
RCWD60-7	600x600

Add 'X' to the end of the code for 350mm deep [650x650]

MEDIUM WALL

'L' Shaped Corner



H:720mm CODE	WIDTH
RCWL60-7	600x600

Bi-fold hinge system  
Add 'X' to the end of the code for 350mm deep [650x650]

Conventional Corner



H:720mm CODE	WIDTH
RWUC60-7	600

Inc. Corner Post  
Add 'X' to the end of the code for 350mm deep

Splayed



H:720mm CODE	WIDTH
RAWU360-7	360

Add 'X' to the end of the code for 350mm deep

Microwave Wall



H:720mm CODE	WIDTH
RMWU60-7	600

283mm flap, 110mm filler; Mechanism inc.  
Add 'X' to the end of the code for 350mm deep

Bi-Fold



H:720mm CODE	WIDTH
RBFWU50-7	500
RBFWU60-7	600
RBFWU80-7	800
RBFWU90-7	900
RBFWU10-7	1000

Mechanism inc.  
Add 'X' to the end of the code for 350mm deep

TALL WALL

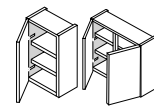

H:900mm CODE	WIDTH	CODE	WIDTH
RWU30-9	300	R2WU60-9*	600
RWU40-9	400	RWU80-9#	800
RWU45-9	450	RWU90-9#	900
RWU50-9	500	RWU10-9#	1000
RWU60-9	600	*No muntin [2x300 doors]	
		# 2 x Doors	

Add 'X' to the end of the code for 350mm deep

Glazed Door

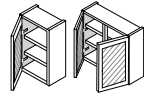

H:900mm CODE	WIDTH
RWG50-9	500
RWG10-9	1000

Add 'X' to the end of the code for 350mm deep

TALL WALL HORIZONTAL WALL GLAZED DRESSER OPEN WALL

**Diagonal Corner**

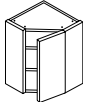

H:900mm  
CODE  
**RCWD60-9** WIDTH  
600x600  
Add 'X' to the end of the code for 350mm deep [650x650]

**Splayed**

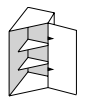

H:900mm  
CODE  
**RAWU360-9** WIDTH  
360  
Add 'X' to the end of the code for 350mm deep

**Boiler Wall**

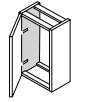

H:900mm  
CODE  
**BWU6040-9** WIDTH  
600  
400mm Deep Flatpack

**HORIZONTAL WALL**

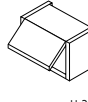

H:290mm  
CODE  
**RHWU5029** WIDTH  
500  
**RHWU6029** 600  
**RHWU8029** 800  
**RHWU9029** 900  
**RHWU1029** 1000  
Add 'X' to the end of the code for 350mm deep

**GLAZED DRESSER**

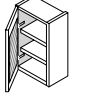

H:1210mm  
CODE  
**RDR1/50** WIDTH  
500  
Dresser Unit - 1 door  
Add 'X' to the end of the code for 350mm deep

**OPEN WALL**

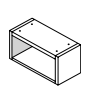

H:290mm  
CODE  
**RWOS50-2** WIDTH  
500  
**RWOS60-2** 600  
**RWOS80-2** 800  
**RWOS90-2** 900  
**RWOS10-2** 1000  
MFC Carcase

**OPEN WALL**

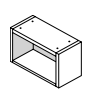

H:360mm  
CODE  
**RWOS50-3** WIDTH  
500  
**RWOS60-3** 600  
**RWOS80-3** 800  
**RWOS90-3** 900  
**RWOS10-3** 1000  
MFC Carcase

If 350mm deep carcase is required adjust code, e.g RWOS1035-2

If 350mm deep carcase is required adjust code, e.g RWOS1035-3

OPEN WALL MIDI UNITS LARDER

**OPEN WALL**



H:575mm  
CODE  
**RWOS30-5** WIDTH  
300  
**RWOS40-5** 400  
**RWOS45-5** 450  
**RWOS50-5** 500  
**RWOS60-5** 600  
**RWOS80-5** 800  
**RWOS90-5** 900  
**RWOS10-5** 1000  
MFC Carcase

**OPEN WALL**



H:720mm  
CODE  
**RWOS30-7** WIDTH  
300  
**RWOS40-7** 400  
**RWOS45-7** 450  
**RWOS50-7** 500  
**RWOS60-7** 600  
**RWOS80-7** 800  
**RWOS90-7** 900  
**RWOS10-7** 1000  
MFC Carcase

**OPEN WALL**



H:900mm  
CODE  
**RWOS30-9** WIDTH  
300  
**RWOS40-9** 400  
**RWOS45-9** 450  
**RWOS50-9** 500  
**RWOS60-9** 600  
**RWOS80-9** 800  
**RWOS90-9** 900  
**RWOS10-9** 1000  
MFC Carcase

**MIDI UNITS**



H:1210mm  
CODE  
**RDC1/50** WIDTH  
500  
**RDC1/60** 600  
MFC Carcase

If 350mm deep carcase is required adjust code, e.g RDC1/3550

**LARDER**



RMLU60 RMA160



RMD060 RMOH560

H:1250mm  
CODE  
**RMLU60** WIDTH  
600  
**RMA160** 600  
**RMD060** 600  
**RMOH560** 600

**LARDER**



H:1970mm  
CODE  
**RTLU30** WIDTH  
300  
**RTLU40** 400  
**RTLU50** 500  
**RTLU60** 600  
**TLU80** 800  
**TLU10** 1000

**LARDER**



H:2150mm  
CODE  
**RETLU30** WIDTH  
300  
**RETLU40** 400  
**RETLU50** 500  
**RETLU60** 600  
**ETLU80** 800  
**ETLU10** 1000

LARDER PULL-OUT LARDER INNER DRAWER LARDER

**LARDER**

**Drawer Larder**

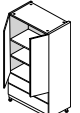

H:1970mm  
CODE  
**TDLU80** WIDTH  
800  
**TDLU10** 1000  
2x355mm Drawers

**LARDER**

**'L' Shaped**

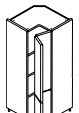

H:1970mm  
CODE  
**TCLU98** \*H:2150mm  
985x985  
**ETCLU98\*** 985x985  
Bi-fold hinge system

**LARDER**

**Diagonal Walk-in Larder**

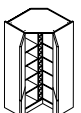

H:1970mm  
CODE  
**TDWIL1144** \*H:2150mm  
1144x1144  
**ETDWIL1144\*** 1144x1144

**LARDER**

**Diagonal**

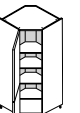

H:1970mm  
CODE  
**TDCLU1003** \*H:2150mm  
1003x1003  
**ETDCLU1003\*** 1003x1003

**PULL-OUT LARDER**

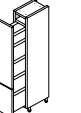

H:1970mm  
CODE  
**RTISPOL30** \*H:2150mm  
300  
**RTKPOL30** 300  
**RETISPOL30\*** 300  
**RETKPOL30\*** 300  
Standard Mechanism inc.  
Kesseböhmer Mechanism inc.

**INNER DRAWER LARDER**

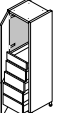

H:1970mm  
CODE  
**RTLID30** WIDTH  
300  
**RTLID40** 400  
**RTLID50** 500  
**RTLID60** 600  
1 x Standard, 4 x Deep drawers

**INNER DRAWER LARDER**

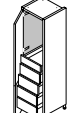

H:2150mm  
CODE  
**RETLID30** WIDTH  
300  
**RETLID40** 400  
**RETLID50** 500  
**RETLID60** 600

DOUBLE OVEN SINGLE OVEN SINGLE OVEN + COMPACT COMPACT TALL FRIDGE/FREEZER BOX WINE RACKS

**DOUBLE OVEN**

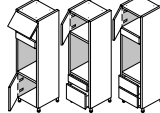

H:1970mm  
CODE  
**RTOHD60** \*H:2150mm  
600  
**RTOHD60** 600  
**RETOHD60\*** 600

**SINGLE OVEN**

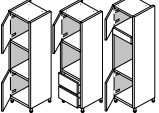

H:1970mm  
CODE  
**RTOHS60** \*H:2150mm  
600  
**RTOHS60** 600  
**RETOHS60\*** 600

**SINGLE OVEN + COMPACT**

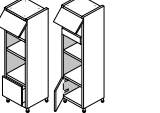

H:1970mm  
CODE  
**RTOHC60** \*H:2150mm  
600  
**RETOHC60\*** 600

**COMPACT**

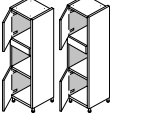

H:1970mm  
CODE  
**RTOHC60** WIDTH  
600  
**RETOHC60\*** 600

**TALL FRIDGE/FREEZER**

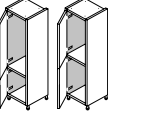

H:1970mm  
CODE  
**RTFF1/60** WIDTH  
600  
**RTFF3/60\*** 600  
**RTFF1U/60#** 600  
**RTFF3U/60#** 600  
\*Doors supplied undrilled  
# For door on door appliances

**TALL FRIDGE/FREEZER**

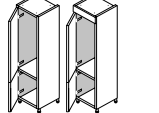

H:2150mm  
CODE  
**RETF1/60** WIDTH  
600  
**RETF2/60** 600  
**RETF1U/60#** 600  
**RETF2U/60#** 600  
# For door on door appliances

**BOX WINE RACKS**

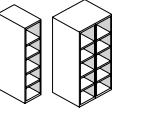

W:125mm / W:250mm\*  
CODE  
**RWR125-7** HEIGHT  
720  
**RWR250-7\*** 720  
**RWR125-9** 900  
**RWR250-9\*** 900  
**RWR125-1210** 1210  
**WR125-1970** 1970  
**WR250-1970\*** 1970  
MFC Carcase  
If using as base order LEGSET

END SUPPORT PANELS CARCASE MFC PANELS CORNICE - MODERN PLINTH PLANT ON END PANELS

**END SUPPORT PANELS**



H:900mm  
CODE  
**ESP** WIDTH  
600  
**900/700** 700  
MFC Carcase

**CARCASE MFC PANELS**

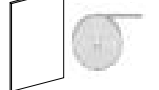

CODE  
**1970/300** WXH  
300x1970  
**2150/560** 560x2150  
**2350/660** 660x2350  
**720/300** 300x720  
**900/2000** 2000x900  
**900/300** 300x900  
MFC Carcase  
**UG/\*ET** 1000x22  
\*Un-Glued 1m Carcase Edging

**CORNICE - MODERN**

**Modern**



H:31mm  
CODE  
**CM/OF** WIDTH  
3000  
Door Finish

**PLINTH**



H:150mm  
CODE  
**PL** WIDTH  
2940  
MFC Carcase  
**PL/OF** 2400  
Door Finish

**PLANT ON END PANELS**

**Clear Sealing Strip**



CODE  
**PST** WIDTH  
3000

**PLANT ON END PANELS**

**18mm Plain**



CODE  
**1387/350P/OF** WXH  
350x1387  
**2400/650P/OF** 650x2400  
**900/650P/OF** 650x900  
**964/350P/OF** 350x964  
Door Finish

**PLANT ON END PANELS**

**18mm Tongue & Grooved**



CODE  
**1387/350T/18OF** WXH  
350x1387  
**2400/650T/18OF** 650x2400  
**900/650T/18OF** 650x900  
**964/350T/18OF** 350x964  
Door Finish

PLANT ON END PANELS FURNITURE ACCESSORIES INTEGRATED DOORS SPARE DOOR FITTINGS GENERAL ACCS.

**PLANT ON END PANELS**

**18mm Plain Breakfast Bar Panel**



CODE  
**915/2400P/OF** WXH  
2400x915  
Door Finish

**PLANT ON END PANELS**

**18mm Tongue & Grooved Breakfast Bar Panel**



CODE  
**915/2400T/OF** WXH  
2400x915  
Door Finish

**FURNITURE ACCESSORIES**

**Corner Post [Spare]**



H:715mm  
CODE  
**CP/OF\*1** WIDTH  
146  
Flat Panel for on site conversion  
Door Finish

**FURNITURE ACCESSORIES**

**Door Hung Spice Rack**



H:1050mm  
CODE  
**DHSR/BNO** WXD  
350x106

**INTEGRATED DOORS**

**Undrilled**

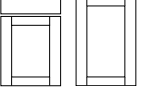

CODE  
**INT4571** WXH  
446x715  
**INT6071** 596x715

**SPARE DOOR FITTINGS**

**Hinges**  
[Hettich Soft Close]

CODE  
**SCHINGE90** 90 degree [Pair]  
**SCHINGE170** 170 degree [Pair]  
Stays [Blum Aventos]  
CODE  
**BLSTAYHKS**  
HK-5 stay [Pair]  
\*[inc mounting brackets]

**GENERAL ACCS.**

CODE  
**STPWN** Set of 2  
Door Strapping Plates  
**LEGSET** Set of 4  
Adjustable legs  
**SACC** Pk 50  
14mm Self Adhesive Cover Caps

Note: Furniture codes beginning with the letter 'R' are assembled (rigid), by removing the 'R' the units are supplied unassembled (flat-pack).



SLAB  
PRICE GROUP 2  
**DARGA**

Colours Options [PG2]: Cashmere, Cloud, Dust Grey, Graphite, Light Grey and White.



HI-LINE BASE LOW BASE HI-LINE CORNER BASE

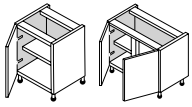

H:720mm CODE	WIDTH	CODE	WIDTH
RBA15	150	R2BA60*#	600
RBA26	260	RBA70#	700
RBA30	300	RBA80#	800
RBA35	350	RBA90#	900
RBA40	400	RBA10#	1000
RBA45	450	RBA12#	1200
RBA50	500	*No muntin [2x300 doors]	
RBA60	600	# 2 x Doors	

Pull-Out

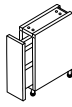

H:720mm CODE	WIDTH	H:720mm CODE	WIDTH
RBISPO15	150	RBKPO15	150
Standard Mechanism inc.			
Kessebohmer Mechanism inc.			
RBKTP015 150			
Kessebohmer Mechanism & Towel rail inc.			

Splayed

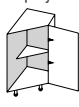

H:720mm CODE	WIDTH
RABA360	360

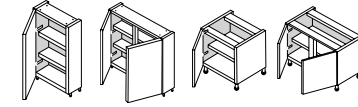

H:720mm CODE	WIDTH	H:575mm CODE	WIDTH
RSBU30	300	RLBU30	300
RSBU35	350	RLBU40	400
RSBU40	400	RLBU45	450
RSBU45	450	RLBU50	500
RSBU50	500	RLBU60	600
RSBU60	600	RLBU80#	800
RSBU70#	700	RLBU90#	900
RSBU80#	800	RLBU10#	1000
RSBU90#	900	RLBU12#	1200
RSBU10#	1000	# 2 x Doors	

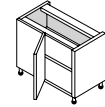

H:720mm CODE	WIDTH	CODE	WIDTH
RBAC830	800/300	RBAC950	900/500
RBAC80	800/400	RBAC960	900/600
RBAC85	800/450	RBAC140	1000/400
RBAC800	800/500	RBAC145	1000/450
RBAC860	800/600	RBAC10	1000/500
RBAC940	900/400	RBAC160	1000/600
RBAC945	900/450	RBAC12	1200/600

Inc. Corner Post & Blanking Panel

Curved Door

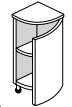

H:720mm CODE	WIDTH
RCDRBA30	300x300

Curved Return [300mm deep]

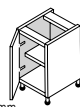

H:720mm CODE	WIDTH
RCRBA26	260

HI-LINE CORNER BASE DRAWERLINE BASE DRAWERLINE SINK BASE CERAMIC SINK BASE DRAWERLINE CORNER BUILT UNDER 2 DRAWER BASE

'L' Shaped

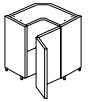

H:720mm CODE	WIDTH
BAC90	900x900

Diagonal



H:720mm CODE	WIDTH
CDA90	900x900

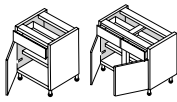

H:720mm CODE	WIDTH	H:720mm CODE	WIDTH
RBD30	300	RBD80/1	800
RBD40	400	RBD90/1	900
RBD45	450	RBD10/1	1000
RBD50	500	RBD50	500
RBD60	600	RBD80#	800
RBD80#	800	RBD90#	900
RBD90#	900	RBD10#	1000
RBD10#	1000	RBD12#	1200
RBD12#	1200	# 2 x Doors	

Single Top Drawer

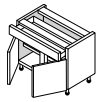

H:720mm CODE	WIDTH	H:720mm CODE	WIDTH
RBD80/1	800	RBD50	500
RBD90/1	900	RBD60	600
RBD10/1	1000	RBD80#	800
RBD50	500	RBD90#	900
RBD80#	800	RBD10#	1000
RBD90#	900	RBD12#	1200
RBD10#	1000	*One working drawer	
RBD12#	1200	# 2 x Doors	

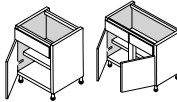

H:720mm CODE	WIDTH	CODE	WXH
RBD50	500	RBSU60	600x460
RBD60	600	To suit a sink height of 260mm	
RBD80#	800	RBDC830	800/300
RBD90#	900	RBDC80	800/400
RBD10#	1000	RBDC845	800/450
RBD12#	1200	RBDC850	800/500
*One working drawer			
# 2 x Doors			

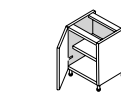

CODE	WXH
RBSU60	600x460



H:720mm CODE	WIDTH	H:720mm CODE	WIDTH
RBDC830	800/300	RBDC10	1000/500
RBDC80	800/400	RBDC145	1000/450
RBDC845	800/450	RBDC160	1000/600
RBDC850	800/500	RBDC12	1200/600
RBDC860	800/600	Inc. Corner Post & Blanking Panel	

Oven

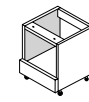

H:720mm CODE	WIDTH	H:720mm CODE	WIDTH
RBUM60	600	RBD250	500

Microwave



H:720mm CODE	WIDTH
RBUM60	600



H:720mm CODE	WIDTH	H:720mm CODE	WIDTH
RBD250	500	RBD280	800
RBD260	600	RBD290	900
RBD280	800	RBD210	1000
RBD290	900	2x355mm Drawers	
RBD210	1000		

3 DRAWER BASE 4 DRAWER BASE 5 DRAWER BASE LOW WALL Diagonal Corner Splayed MEDIUM WALL

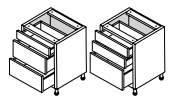

H:720mm CODE	WIDTH	H:720mm CODE	WIDTH
RBD350	500	RBD450	500
RBD360	600	RBD460	600
RBD380	800	RBD480	800
RBD390	900	RBD490	900
RBD310	1000	RBD410	1000
1x140mm, 2x283mm Drawers			
RBD350/175	500	RBD450/175	500
RBD360/175	600	RBD460/175	600
2x175mm, 1x355mm Drawers			

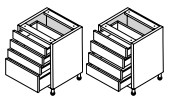

H:720mm CODE	WIDTH	H:720mm CODE	WIDTH
RBD450	500	RBD530	300
RBD460	600	RBD540	400
RBD480	800	RBD545	450
RBD490	900	RBD550	500
RBD410	1000	RBD560	600
3x140mm, 1x283mm Drawers			
RBD450/175	500	RBD580	800
RBD460/175	600	RBD590	900
4x175mm Drawers			
RBD510	1000		



H:720mm CODE	WIDTH	H:720mm CODE	WIDTH
RBD530	300	RWD30-5	300
RBD540	400	RWD40-5	400
RBD545	450	RWD45-5	450
RBD550	500	RWD50-5	500
RBD560	600	RWD60-5	600
RBD580	800	R2WU60-5*#	600
RBD590	900	RWD70-5#	700
RBD510	1000	RWD80-5#	800
5x140mm Drawers			

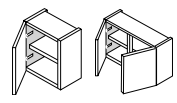

H:575mm CODE	D:300mm WIDTH	H:575mm CODE	D:300mm WIDTH
RWD30-5	300	RCWD60-5	600x600
RWD40-5	400	Add 'X' to the end of the code for 350mm deep [650x650]	
RWD45-5	450	RAWU360-5	360
RWD50-5	500	Add 'X' to the end of the code for 350mm deep	
RWD60-5	600	Add 'X' to the end of the code for 350mm deep	
R2WU60-5*#	600		
RWD70-5#	700		
RWD80-5#	800		
RWD90-5#	900		
RWD10-5#	1000		
*No muntin [2 x 300 doors]			
# 2 x Doors			
Add 'X' to the end of the code for 350mm deep			

Diagonal Corner

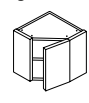

Splayed

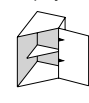

MEDIUM WALL

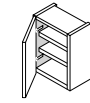

H:720mm CODE	WIDTH	CODE	D:300mm WIDTH
RWD26-7	260	R2WU60-7*#	600
RWD30-7	300	RWD70-7#	700
RWD35-7	350	RWD80-7#	800
RWD40-7	400	RWD90-7#	900
RWD45-7	450	RWD10-7#	1000
RWD50-7	500	*No muntin [2x300 doors]	
RWD60-7	600	# 2 x Doors	

Add 'X' to the end of the code for 350mm deep

MEDIUM WALL Glazed Door Diagonal Corner 'L' Shaped Corner Conventional Corner Splayed Curved Door Microwave Wall

Glazed Door

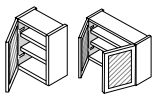

H:720mm CODE	D:300mm WIDTH	H:720mm CODE	D:300mm WIDTH
RWG50-7*	500	RCWD60-7	600x600
RWG10-7*	1000	Add 'X' to the end of the code for 350mm deep [650x650]	

Diagonal Corner

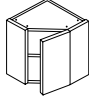

H:720mm CODE	D:300mm WIDTH	H:720mm CODE	D:300mm WIDTH
RCWD60-7	600x600	RCWL60-7	600x600

'L' Shaped Corner

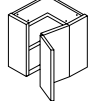

H:720mm CODE	D:300mm WIDTH	H:720mm CODE	D:300mm WIDTH
RCWL60-7	600x600	RCWL60-7	600x600

Conventional Corner

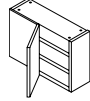

H:720mm CODE	D:300mm WIDTH	H:720mm CODE	D:300mm WIDTH
RWUC60-7	600	RAWU360-7	360

Splayed

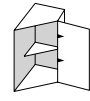

H:720mm CODE	D:300mm WIDTH	H:720mm CODE	D:300mm WIDTH
RAWU360-7	360	RCWDU30-7	300x300

Curved Door

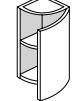

H:720mm CODE	WIDTH
RCWDU30-7	300x300

Microwave Wall

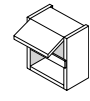

H:720mm CODE	D:300mm WIDTH
RMWU60-7	600

283mm flap, 110mm filler; Mechanism inc.  
Add 'X' to the end of the code for 350mm deep



MEDIUM WALL

Bi-Fold



H:720mm CODE	D:300mm WIDTH
RBFWU50-7	500
RBFWU60-7	600
RBFWU80-7	800
RBFWU90-7	900
RBFWU10-7	1000

Mechanism inc.  
Add 'X' to the end of the code for 350mm deep

TALL WALL

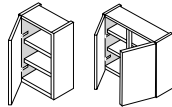

Glazed Door

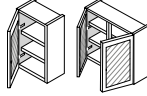

Diagonal Corner

Splayed



Boiler Wall



H:900mm CODE	WIDTH	CODE	D:300mm WIDTH
RWU30-9	300	R2WU60-9*	600
RWU40-9	400	RWU80-9#	800
RWU45-9	450	RWU90-9#	900
RWU50-9	500	RWU10-9#	1000
RWU60-9	600	*No muntin [2x300 doors] # 2 x Doors	

Add 'X' to the end of the code for 350mm deep

HORIZONTAL WALL

OPEN WALL

OPEN WALL

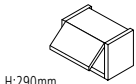

H:290mm *H:360mm CODE	D:300mm WIDTH
RHWU5029	500
RHWU6029	600
RHWU8029	800
RHWU9029	900
RHWU1029	1000
RHWU5036*	500
RHWU6036*	600
RHWU8036*	800
RHWU9036*	900
RHWU1036*	1000

Add 'X' to the end of the code for 350mm deep

H:290mm CODE	D:300mm WIDTH	H:360mm CODE	D:300mm WIDTH
RWOS50-2	500	RWOS50-3	500
RWOS60-2	600	RWOS60-3	600
RWOS80-2	800	RWOS80-3	800
RWOS90-2	900	RWOS90-3	900
RWOS10-2	1000	RWOS10-3	1000

MFC Carcase  
If 350mm deep carcase is required adjust code, e.g RWOS1035-2

MIDI UNITS

LARDER

RMLU60 RMA160

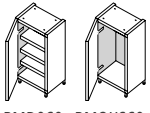

H:1250mm CODE	WIDTH
RMLU60	600
RMA160	600
RMD060	600
RMOH560	600

Drawer Larder

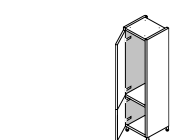

H:1970mm CODE	WIDTH	H:2150mm CODE	WIDTH
RTL30	300	RETL30	300
RTLU40	400	RETLU40	400
RTLU50	500	RETLU50	500
RTLU60	600	RETLU60	600
TLU80	800	ETLU80	800
TLU10	1000	ETLU10	1000

2x355mm Drawers

INNER DRAWER LARDER

DOUBLE OVEN

SINGLE OVEN

SINGLE OVEN + COMPACT

COMPACT

TALL FRIDGE/FREEZER

TALL FRIDGE/FREEZER

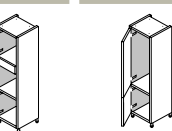
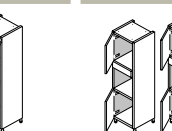
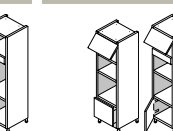
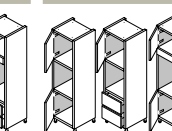
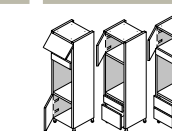
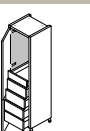

H:1970mm CODE	WIDTH
RTLID30	300
RTLID40	400
RTLID50	500
RTLID60	600

1 x Standard, 4 x Deep drawers

H:2150mm CODE	WIDTH	H:1970mm CODE	*H:2150mm WIDTH
RETLD30	300	RTOHD60	600
RETLD40	400	RTOHDD60	600
RETLD50	500	RETOHDD60*	600
RETLD60	600		

H:1970mm CODE	*H:2150mm WIDTH	H:1970mm CODE	*H:2150mm WIDTH
RTOHS60	600	RTOHSD60	600
RETOHS60*	600		

H:1970mm CODE	*H:2150mm WIDTH
RTOHSC60	600
RETOHSC60*	600

Bi-fold hinge system

H:1970mm CODE	*H:2150mm WIDTH
TDCLU1003	1003x1003
ETDCLU1003*	1003x1003

H:1970mm CODE	*H:2150mm WIDTH
TDWIL1144	1144x1144
ETDWIL1144*	1144x1144

H:1970mm CODE	*H:2150mm WIDTH
RTISPOL30	300
RTKPOL30	300
RETISPOL30*	300
RETKPOL30*	300

Standard Mechanism inc.  
Kesseböhmer Mechanism inc.

BOX WINE RACKS

END SUPPORT PANELS

CARCASE MFC PANELS

CORNICE + PELMET

PLINTH

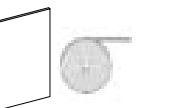
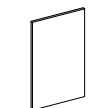
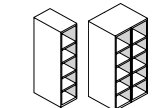

W:125mm / W:250mm* CODE	HEIGHT
RWR125-7	720
RWR250-7*	720
RWR125-9	900
RWR250-9*	900
WR125-1210	1210
WR125-1970	1970
WR250-1970*	1970

MFC Carcase  
If using as base order LEGSET

H:900mm CODE	WIDTH	CODE	WXH
ESP	600	1970/300	300x1970
	700	2150/560	560x2150
		2350/660	660x2350
		720/300	300x720
		900/2000	2000x900
		900/300	300x900

MFC Carcase

H:28mm CODE	LENGTH	H:28mm CODE	WIDTH
CM/UG	3000	CCMS/UG	450x450

Door Finish  
Use in conjunction with CM/UG

H:150mm CODE	WIDTH	H:150mm CODE	WIDTH
PL	2940	PST	3000

MFC Carcase  
Door Finish

PLINTH

PLANT ON END PANELS

FURNITURE ACCESSORIES

INTEGRATED DOORS

SPARE DOOR FITTINGS

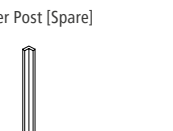
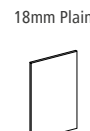
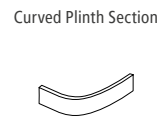

H:150mm CODE	WXD
CPLS/UG	430x320

Door Finish  
Use in conjunction with PL/UG

18mm Plain CODE	WXH	18mm Plain Breakfast Bar Panel CODE	WXH
2430/650/18UG	650x2430	900/1200/18UG	1200x900
780/360/18UG	360x780	910/2430/18UG	2430x910
900/650/18UG	650x900		
960/360/18UG	360x960		

Door Finish

H:715mm CODE	WIDTH	CODE	WXH
CP/UG	146	INT4571	446x715
		INT6071	596x715

Flat Panel for on site conversion  
Door Finish

Hinges [Hettich Soft Close] CODE	STAYS [Blum Aventos] CODE
SCHINGE90	BLSTAYHKS
90 degree [Pair]	HK-5 stay [Pair]
SCHINGE170	*[inc mounting brackets]
170 degree [Pair]	

GENERAL ACCS. CODE	DESCRIPTION
STPWN	Set of 2 Door Strapping Plates
LEGSET	Set of 4 Adjustable legs
SACC	Pk 50 14mm Self Adhesive Carcase Cover Caps

Note: Furniture codes beginning with the letter 'R' are assembled (rigid), by removing the 'R' the units are supplied unassembled (flat-pack).

SLAB  
PRICE GROUP 3  
**ENKO**

Special sizes available  
contact us for further information

Colours Options [PG3]: Black, Fern, Hunter, Indigo, Stone and Taupe.



HI-LINE BASE

LOW BASE

				<p>Pull-Out</p>		<p>Splayed</p>		<p>Shallow Base [300mm deep]</p>							
H:720mm		600mm*		H:720mm		H:720mm		H:720mm		H:720mm		H:575mm		H:575mm	
CODE	WIDTH	CODE	WIDTH	CODE	WIDTH	CODE	WIDTH	CODE	WIDTH	CODE	WIDTH	CODE	WIDTH	CODE	WIDTH
RBA15	150	R2BA60*#	600	RBISPO15	150	RABA360	360	RSBU30	300	RSBU70#	700	RLBU30	300	RLBU80#	800
RBA26	260	RBA70#	700	Standard Mechanism inc.				RSBU35	350	RSBU80#	800	RLBU40	400	RLBU90#	900
RBA30	300	RBA80#	800	RBKPO15	150			RSBU40	400	RSBU90#	900	RLBU45	450	RLBU10#	1000
RBA35	350	RBA90#	900	Kessebohmer Mechanism inc.				RSBU45	450	RSBU10#	1000	RLBU50	500	RLBU12#	1200
RBA40	400	RBA10#	1000	RBKTPO15	150			RSBU50	500	# 2 x Doors		RLBU60	600	# 2 x Doors	
RBA45	450	RBA12	1200	Kessebohmer Mechanism & Towel rail inc.				RSBU60	600						
RBA50	500	*No muntin [2 x 300 doors] # 2 x Doors													

HI-LINE CORNER BASE

DRAWERLINE BASE

DRAWERLINE SINK BASE

CERAMIC SINK BASE

DRAWERLINE CORNER

				<p>'L' Shaped</p>		<p>Single Top Drawer</p>									
H:720mm		H:720mm		H:720mm		H:720mm		H:720mm		H:720mm		H:720mm		H:720mm	
CODE	WIDTH	CODE	WIDTH	CODE	WIDTH	CODE	WIDTH	CODE	WIDTH	CODE	WXH	CODE	WIDTH	CODE	WIDTH
RBAC830	800/300	RBAC950	900/500	BAC90	900x900	RBD30	300	RBD80/1	800	RBDF50	500	RBSU60	600x460	RBDC830	800/300
RBAC80	800/400	RBAC960	900/600	Bi-fold hinge system Flat pack		RBD40	400	RBD90/1	900	RBDF60	600	To suit a sink height of 260mm		RBDC80	800/400
RBAC845	800/450	RBAC140	1000/400			RBD45	450	RBD10/1	1000	RBDF80#	800			RBDC845	800/450
RBAC850	800/500	RBAC145	1000/450			RBD50	500			RBDF90#	900			RBDC850	800/500
RBAC860	800/600	RBAC10	1000/500			RBD60	600			RBDF10#	1000			RBDC860	800/600
RBAC940	900/400	RBAC160	1000/600			RBD80#	800			RBDD10*#	1000			RBDC140	1000/400
RBAC945	900/450	RBAC12	1200/600			RBD90#	900			RBDD12*#	1200			RBDC145	1000/450
Inc. Corner Post & Blanking Panel				<p>Diagonal</p>						<p>*One working drawer # 2 x Doors</p>				<p>Inc. Corner Post &amp; Blanking Panel</p>	
H:720mm		H:720mm		H:720mm		H:720mm		H:720mm		H:720mm		H:720mm		H:720mm	
CODE	WIDTH	CODE	WIDTH	CODE	WIDTH	CODE	WIDTH	CODE	WIDTH	CODE	WIDTH	CODE	WIDTH	CODE	WIDTH
CDA90	900x900			Flat pack											

BUILT UNDER

2 DRAWER BASE

3 DRAWER BASE

4 DRAWER BASE

5 DRAWER BASE

LOW WALL

<p>Oven</p>												<p>Diagonal Corner</p>		<p>Splayed</p>	
H:720mm		H:720mm		H:720mm		H:720mm		H:720mm		H:575mm		H:575mm		H:575mm	
CODE	WIDTH	CODE	WIDTH	CODE	WIDTH	CODE	WIDTH	CODE	WIDTH	CODE	WIDTH	CODE	WIDTH	CODE	WIDTH
RBUM60	600	RBD250	500	RBD350	500	RBD450	500	RBD530	300	RWU30-5	300	RCWD60-5	600x600	RAWU360-5	360
		RBD260	600	RBD360	600	RBD460	600	RBD540	400	RWU40-5	400	Add 'X' to the end of the code for 350mm deep [650x650]		RAWU40-5	400
		RBD280	800	RBD380	800	RBD480	800	RBD545	450	RWU45-5	450			RAWU45-5	450
		RBD290	900	RBD390	900	RBD490	900	RBD550	500	RWU50-5	500			RAWU50-5	500
		RBD210	1000	RBD310	1000	RBD410	1000	RBD560	600	RWU60-5	600			RAWU60-5	600
		2x355mm Drawers		1x140mm, 2x283mm Drawers		3x140mm, 1x283mm Drawers		RBD580	800	R2WU60-5*#	600			RAWU70-5	700
				2x175mm, 1x355mm Drawers		4x175mm Drawers		RBD590	900	RWU70-5	700			RAWU80-5	800
								RBD510	1000	RWU80-5	800			RAWU90-5	900
								5x140mm Drawers		RWU10-5	1000			RAWU10-5	1000
										*No muntin [2 x 300 doors] # 2 x Doors					
										Add 'X' to the end of the code for 350mm deep					

MEDIUM WALL

				<p>Diagonal Corner</p>		<p>'L' Shaped Corner</p>				<p>Conventional Corner</p>		<p>Splayed</p>		<p>Microwave Wall</p>		<p>Bi-Fold</p>			
H:720mm		D:300mm		H:720mm		D:300mm		H:720mm		D:300mm		H:720mm		D:300mm		H:720mm		D:300mm	
CODE	WIDTH	CODE	WIDTH	CODE	WIDTH	CODE	WIDTH	CODE	WIDTH	CODE	WIDTH	CODE	WIDTH	CODE	WIDTH	CODE	WIDTH	CODE	WIDTH
RWU26-7	260	R2WU60-7*#	600	RCWD60-7	600x600	RCWL60-7	600x600	RWUC60-7	600	RAWU360-7	360	RMWU60-7	600	RBFWU50-7	500				
RWU30-7	300	RWU70-7	700	Add 'X' to the end of the code for 350mm deep [650x650]		Bi-fold hinge system		Inc. Corner Post		Add 'X' to the end of the code for 350mm deep		283mm flap, 110mm filler; Mechanism inc.		RBFWU60-7	600				
RWU35-7	350	RWU80-7#	800			Add 'X' to the end of the code for 350mm deep [650x650]		Add 'X' to the end of the code for 350mm deep		Add 'X' to the end of the code for 350mm deep		Add 'X' to the end of the code for 350mm deep		RBFWU80-7	800				
RWU40-7	400	RWU90-7#	900											RBFWU90-7	900				
RWU45-7	450	RWU10-7#	1000											RBFWU10-7	1000				
RWU50-7	500	*No muntin [2x300 doors] # 2 x Doors												Mechanism inc.					
RWU60-7	600													Add 'X' to the end of the code for 350mm deep					
Add 'X' to the end of the code for 350mm deep																			



SLAB  
PRICE GROUP 1  
**EPOS**  
Special sizes available  
contact us for further information  
Colours Options [PG1]: Slate



HI-LINE BASE LOW BASE

**Pull-Out**

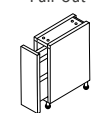

H:720mm  
CODE WIDTH  
**RBISPO15** 150  
Standard Mechanism inc.  
**RBKPO15** 150  
Kessebohmer Mechanism inc.  
**RBKTP015** 150  
Kessebohmer Mechanism & Towel rail inc.

**Splayed**

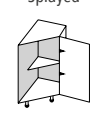

H:720mm  
CODE WIDTH  
**RABA360** 360

**Shallow Base [300mm deep]**

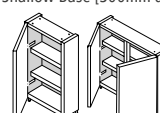

H:720mm  
CODE WIDTH CODE WIDTH  
**RSBU30** 300 **RSBU70#** 700  
**RSBU35** 350 **RSBU80#** 800  
**RSBU40** 400 **RSBU90#** 900  
**RSBU45** 450 **RSBU10#** 1000  
**RSBU50** 500 # 2 x Doors  
**RSBU60** 600

**LOW BASE**

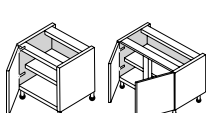

H:575mm  
CODE WIDTH CODE WIDTH  
**RLBU30** 300 **RLBU80#** 800  
**RLBU40** 400 **RLBU90#** 900  
**RLBU45** 450 **RLBU10#** 1000  
**RLBU50** 500 **RLBU12#** 1200  
**RLBU60** 600 # 2 x Doors

HI-LINE CORNER BASE DRAWERLINE BASE DRAWERLINE SINK BASE CERAMIC SINK BASE DRAWERLINE CORNER

**HI-LINE CORNER BASE**

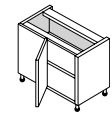

H:720mm  
CODE WIDTH CODE WIDTH  
**RBAC830** 800/300 **RBAC950** 900/500  
**RBAC80** 800/400 **RBAC960** 900/600  
**RBAC845** 800/450 **RBAC140** 1000/400  
**RBAC850** 800/500 **RBAC145** 1000/450  
**RBAC860** 800/600 **RBAC10** 1000/500  
**RBAC940** 900/400 **RBAC160** 1000/600  
**RBAC945** 900/450 **RBAC12** 1200/600  
Inc. Corner Post & Blanking Panel

**HI-LINE CORNER BASE**

**'L' Shaped**

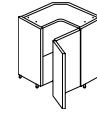

H:720mm  
CODE WIDTH  
**BAC90** 900x900  
Bi-fold hinge system  
Flat pack

**Diagonal**



H:720mm  
CODE WIDTH  
**CDA90** 900x900  
Flat pack

**DRAWERLINE BASE**

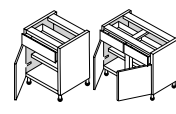

H:720mm  
CODE WIDTH  
**RBD30** 300  
**RBD40** 400  
**RBD45** 450  
**RBD50** 500  
**RBD60** 600  
**RBD80#** 800  
**RBD90#** 900  
**RBD10#** 1000  
**RBD12#** 1200  
# 2 x Doors

**DRAWERLINE SINK BASE**

**Single Top Drawer**



H:720mm  
CODE WIDTH  
**RBD80/1** 800  
**RBD90/1** 900  
**RBD10/1** 1000

**DRAWERLINE SINK BASE**

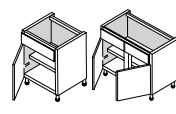

H:720mm  
CODE WIDTH  
**RBDF50** 500  
**RBDF60** 600  
**RBDF80#** 800  
**RBDF90#** 900  
**RBDF10#** 1000  
**RBDD10#** 1000  
**RBDD12#** 1200  
\*One working drawer  
# 2 x Doors

**CERAMIC SINK BASE**

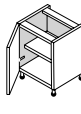

H:720mm  
CODE WxH  
**RBSU60** 600x460  
To suit a sink height of 260mm

**DRAWERLINE CORNER**

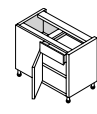

H:720mm  
CODE WIDTH  
**RBDC830** 800/300  
**RBDC80** 800/400  
**RBDC845** 800/450  
**RBDC850** 800/500  
**RBDC860** 800/600  
**RBDC140** 1000/400  
**RBDC145** 1000/450  
**RBDC10** 1000/500  
**RBDC160** 1000/600  
**RBDC12** 1200/600  
Inc. Corner Post & Blanking Panel

BUILT UNDER 2 DRAWER BASE 3 DRAWER BASE 4 DRAWER BASE 5 DRAWER BASE LOW WALL

**BUILT UNDER**

Oven

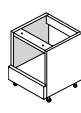

H:720mm  
CODE WIDTH  
**RBUM60** 600

Microwave

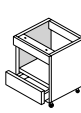

H:720mm  
CODE WIDTH  
**RBUM60** 600  
175mm drawer & 110mm filler

**2 DRAWER BASE**

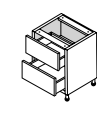

H:720mm  
CODE WIDTH  
**RBD250** 500  
**RBD260** 600  
**RBD280** 800  
**RBD290** 900  
**RBD210** 1000  
2x355mm Drawers

**3 DRAWER BASE**

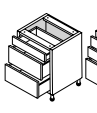

H:720mm  
CODE WIDTH  
**RBD350** 500  
**RBD360** 600  
**RBD380** 800  
**RBD390** 900  
**RBD310** 1000  
1x140mm, 2x283mm Drawers

**4 DRAWER BASE**



H:720mm  
CODE WIDTH  
**RBD450** 500  
**RBD460** 600  
**RBD480** 800  
**RBD490** 900  
**RBD410** 1000  
**RBD350/175** 500  
**RBD360/175** 600  
3x140mm, 1x283mm Drawers  
4x175mm Drawers

**5 DRAWER BASE**



H:720mm  
CODE WIDTH  
**RBD530** 300  
**RBD540** 400  
**RBD545** 450  
**RBD550** 500  
**RBD560** 600  
**RBD580** 800  
**RBD590** 900  
**RBD510** 1000  
5x140mm Drawers

**LOW WALL**

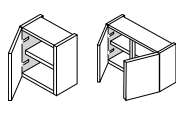

H:575mm D:300mm  
CODE WIDTH  
**RWU30-5** 300  
**RWU40-5** 400  
**RWU45-5** 450  
**RWU50-5** 500  
**RWU60-5** 600  
**R2WU60-5\*** 600  
**RWU70-5#** 700  
**RWU80-5#** 800  
**RWU90-5#** 900  
**RWU10-5#** 1000  
\*No muntin [2 x 300 doors]  
# 2 x Doors  
Add 'X' to the end of the code for 350mm deep

**Diagonal Corner**

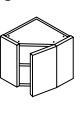

H:575mm D:300mm  
CODE WIDTH  
**RCWD60-5** 600x600  
Add 'X' to the end of the code for 350mm deep [650x650]

**Splayed**

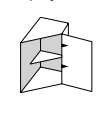

H:575mm D:300mm  
CODE WIDTH  
**RAWU360-5** 360  
Add 'X' to the end of the code for 350mm deep

MEDIUM WALL

**Diagonal Corner**

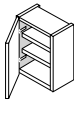

H:720mm D:300mm  
CODE WIDTH CODE WIDTH  
**RWU26-7** 260 **R2WU60-7\*#** 600  
**RWU30-7** 300 **RWU70-7#** 700  
**RWU35-7** 350 **RWU80-7#** 800  
**RWU40-7** 400 **RWU90-7#** 900  
**RWU45-7** 450 **RWU10-7#** 1000  
**RWU50-7** 500 \*No muntin [2x300 doors]  
**RWU60-7** 600 # 2 x Doors  
Add 'X' to the end of the code for 350mm deep

**'L' Shaped Corner**

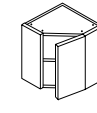

H:720mm D:300mm  
CODE WIDTH CODE WIDTH  
**RCWD60-7** 600x600  
Add 'X' to the end of the code for 350mm deep [650x650]

**Conventional Corner**

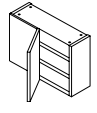

H:720mm D:300mm  
CODE WIDTH CODE WIDTH  
**RCWL60-7** 600x600  
Bi-fold hinge system  
Add 'X' to the end of the code for 350mm deep [650x650]

**Splayed**

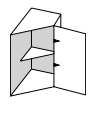

H:720mm D:300mm  
CODE WIDTH CODE WIDTH  
**RWUC60-7** 600  
Inc. Corner Post  
Add 'X' to the end of the code for 350mm deep

**Microwave Wall**

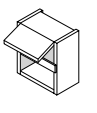

H:720mm D:300mm  
CODE WIDTH CODE WIDTH  
**RAWU360-7** 360  
Add 'X' to the end of the code for 350mm deep

**Bi-Fold**

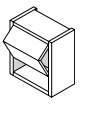

H:720mm D:300mm  
CODE WIDTH CODE WIDTH  
**RMWU60-7** 600  
283mm flap, 110mm filler; Mechanism inc.  
Add 'X' to the end of the code for 350mm deep



TALL WALL HORIZONTAL WALL

**Diagonal Corner**

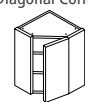

H:900mm	D:300mm
CODE	WIDTH
<b>RWU30-9</b>	300
<b>RWU40-9</b>	400
<b>RWU45-9</b>	450
<b>RWU50-9</b>	500
<b>RWU60-9</b>	600

**Splayed**

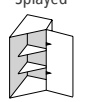

H:900mm	D:300mm
CODE	WIDTH
<b>RAWU360-9</b>	360

**Boiler Wall**

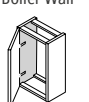

H:900mm	D:300mm
CODE	WIDTH
<b>BWU6040-9</b>	600

**HORIZONTAL WALL**

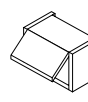

H:290mm	D:300mm
CODE	WIDTH
<b>RHWU5029</b>	500
<b>RHWU6029</b>	600
<b>RHWU8029</b>	800
<b>RHWU9029</b>	900
<b>RHWU1029</b>	1000

**OPEN WALL**



H:290mm	D:300mm
CODE	WIDTH
<b>RWOS50-2</b>	500
<b>RWOS60-2</b>	600
<b>RWOS80-2</b>	800
<b>RWOS90-2</b>	900
<b>RWOS10-2</b>	1000

**MIDI UNITS**

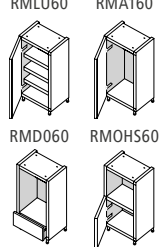

H:1250mm	D:300mm
CODE	WIDTH
<b>RMLU60</b>	600
<b>RMA160</b>	600
<b>RMD060</b>	600
<b>RMOHS60</b>	600

**OPEN WALL (continued)**



H:360mm	D:300mm
CODE	WIDTH
<b>RWOS50-3</b>	500
<b>RWOS60-3</b>	600
<b>RWOS80-3</b>	800
<b>RWOS90-3</b>	900
<b>RWOS10-3</b>	1000

**OPEN WALL (continued)**



H:575mm	D:300mm
CODE	WIDTH
<b>RWOS30-5</b>	300
<b>RWOS40-5</b>	400
<b>RWOS45-5</b>	450
<b>RWOS50-5</b>	500
<b>RWOS60-5</b>	600
<b>RWOS80-5</b>	800
<b>RWOS90-5</b>	900
<b>RWOS10-5</b>	1000

**OPEN WALL (continued)**



H:720mm	D:300mm
CODE	WIDTH
<b>RWOS30-7</b>	300
<b>RWOS40-7</b>	400
<b>RWOS45-7</b>	450
<b>RWOS50-7</b>	500
<b>RWOS60-7</b>	600
<b>RWOS80-7</b>	800
<b>RWOS90-7</b>	900
<b>RWOS10-7</b>	1000

**OPEN WALL (continued)**



H:900mm	D:300mm
CODE	WIDTH
<b>RWOS30-9</b>	300
<b>RWOS40-9</b>	400
<b>RWOS45-9</b>	450
<b>RWOS50-9</b>	500
<b>RWOS60-9</b>	600
<b>RWOS80-9</b>	800
<b>RWOS90-9</b>	900
<b>RWOS10-9</b>	1000

**OPEN WALL (continued)**



H:1210mm	D:300mm
CODE	WIDTH
<b>RDC1/50</b>	500
<b>RDC1/60</b>	600

**LARDER**

**Single Door**

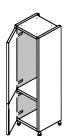

H:1970mm	D:300mm
CODE	WIDTH
<b>RTL30</b>	300
<b>RTL40</b>	400
<b>RTL50</b>	500
<b>RTL60</b>	600
<b>TLU80</b>	800
<b>TLU10</b>	1000

**Drawer Larder**

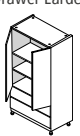

H:1970mm	D:300mm
CODE	WIDTH
<b>TDLU80</b>	800
<b>TDLU10</b>	1000

**'L' Shaped**

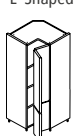

H:1970mm	*H:2150mm
CODE	WIDTH
<b>TCLU98</b>	985x985
<b>ETCLU98*</b>	985x985

**Diagonal**

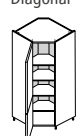

H:1970mm	*H:2150mm
CODE	WIDTH
<b>TDCLU1003</b>	1003x1003
<b>ETDCLU1003*</b>	1003x1003

**Diagonal Walk-in Larder**

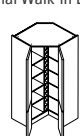

H:1970mm	*H:2150mm
CODE	WIDTH
<b>TDWIL1144</b>	1144x1144
<b>ETDWIL1144*</b>	1144x1144

**PULL-OUT LARDER**

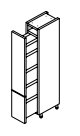

H:1970mm	*H:2150mm
CODE	WIDTH
<b>RTSPOL30</b>	300
<b>RTKPOL30</b>	300

**INNER DRAWER LARDER**

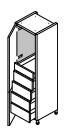

H:1970mm	D:300mm
CODE	WIDTH
<b>RTLID30</b>	300
<b>RTLID40</b>	400
<b>RTLID50</b>	500
<b>RTLID60</b>	600

**DOUBLE OVEN**

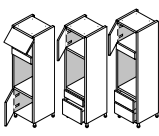

H:1970mm	*H:2150mm
CODE	WIDTH
<b>RTOHD60</b>	600
<b>RTOHDD60</b>	600
<b>RETOHDD60*</b>	600

**SINGLE OVEN**

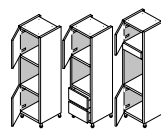

H:1970mm	*H:2150mm
CODE	WIDTH
<b>RTOHS60</b>	600
<b>RTOHS60*</b>	600

**SINGLE OVEN + COMPACT**

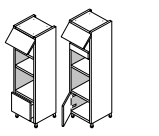

H:1970mm	*H:2150mm
CODE	WIDTH
<b>RTOHC60</b>	600
<b>RETOHC60*</b>	600

**COMPACT**



H:1970mm	*H:2150mm
CODE	WIDTH
<b>RTOHC60</b>	600
<b>RETOHC60*</b>	600

**TALL FRIDGE/FREEZER**

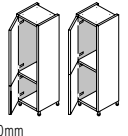

H:1970mm	D:300mm
CODE	WIDTH
<b>RTFF1/60</b>	600
<b>RTFF4/60*</b>	600

**TALL FRIDGE/FREEZER**

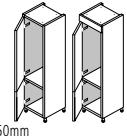

H:2150mm	D:300mm
CODE	WIDTH
<b>RETF1/60</b>	600
<b>RETF2/60</b>	600
<b>RETF1U/60#</b>	600
<b>RETF2U/60#</b>	600

**BOX WINE RACKS**

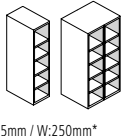

W:125mm / W:250mm*	HEIGHT
<b>RWR125-7</b>	720
<b>RWR250-7*</b>	720
<b>RWR125-9</b>	900
<b>RWR250-9*</b>	900
<b>RWR125-1210</b>	1210
<b>WR125-1970</b>	1970
<b>WR250-1970*</b>	1970

**END SUPPORT PANELS**

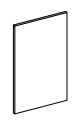

H:900mm	D:300mm
CODE	WIDTH
<b>ESP</b>	600
<b>900/700</b>	700

**CARCASE MFC PANELS**

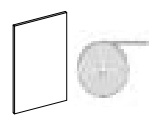

H:900mm	D:300mm
CODE	WXH
<b>1970/300</b>	300x1970
<b>2150/560</b>	560x2150
<b>2350/660</b>	660x2350
<b>720/300</b>	300x720
<b>900/2000</b>	2000x900
<b>900/300</b>	300x900

**PLINTH**



H:150mm	D:2940mm
CODE	WIDTH
<b>PL</b>	2940

**Clear Sealing Strip**

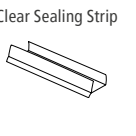

H:150mm	D:3000mm
CODE	WIDTH
<b>PST</b>	3000

**PLANT ON END PANELS**



CODE	WXH
<b>2400/650/18PSL</b>	650x2400
<b>900/350/18PSL</b>	350x900
<b>900/650/18PSL</b>	650x900

**FURNITURE ACCESSORIES**



H:715mm	D:146mm
CODE	WIDTH
<b>CP/PSL</b>	146

**INTEGRATED DOORS**

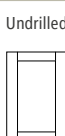

CODE	WXH
<b>INT4571</b>	446x715
<b>INT6071</b>	596x715

**SPARE DOOR FITTINGS**



CODE	DESCRIPTION
<b>SCHINGE90</b>	90 degree [Pair]
<b>SCHINGE170</b>	170 degree [Pair]

**GENERAL ACCS.**



CODE	DESCRIPTION
<b>STPWPN</b>	Set of 2 Door Strapping Plates
<b>LEGSET</b>	Set of 4 Adjustable legs
<b>SACC</b>	Pk 50 14mm Self Adhesive Carcase Cover Caps

Note: Furniture codes beginning with the letter 'R' are assembled (rigid), by removing the 'R' the units are supplied unassembled (flat-pack).



SLAB  
PRICE GROUP 3  
**JUKO MATT**

*Special sizes available*  
contact us for further information

Colours Options [PG3]: Ash, Cloud and Graphite.



**HI-LINE BASE**

<b>H:720mm</b>	<b>CODE</b>	<b>WIDTH</b>	<b>CODE</b>	<b>WIDTH</b>	<b>H:720mm</b>	<b>CODE</b>	<b>WIDTH</b>	<b>H:720mm</b>	<b>CODE</b>	<b>WIDTH</b>	<b>H:720mm</b>	<b>CODE</b>	<b>WIDTH</b>
RBA15	150	R2BA60*	600	RBISPO15	150	RCRBA30	300x300	RCRBA26	260	RABA360	360	RSBU30	300
RBA26	260	RBA70#	700	Standard Mechanism inc.						RSBU35	350	RSBU40	400
RBA30	300	RBA80#	800	Kesseböhmer Mechanism inc.						RSBU45	450	RSBU50	500
RBA35	350	RBA90#	900	Kesseböhmer Mechanism & Towel rail inc.						RSBU60	600	RSBU70#	700
RBA40	400	RBA10#	1000									RSBU80#	800
RBA45	450	RBA12#	1200									RSBU90#	900
RBA50	500	*No muntin [2x300 doors]										RSBU10#	1000
RBA60	600	#2 x Doors										#2 x Doors	

**LOW BASE**

**HI-LINE CORNER BASE**

**DRAWERLINE BASE**

<b>H:575mm</b>	<b>CODE</b>	<b>WIDTH</b>	<b>H:720mm</b>	<b>CODE</b>	<b>WIDTH</b>	<b>H:720mm</b>	<b>CODE</b>	<b>WIDTH</b>	<b>H:720mm</b>	<b>CODE</b>	<b>WIDTH</b>
RLBU30	300	RBAC830	800/300	RBAC950	900/500	BAC90	900x900	CDA90	900x900	RBD30	300
RLBU40	400	RBAC80	800/400	RBAC960	900/600	Bi-fold hinge system Flatpack		RBD40	400	RBD80#	800
RLBU45	450	RBAC845	800/450	RBAC140	1000/400			RBD45	450	RBD90#	900
RLBU50	500	RBAC850	800/500	RBAC145	1000/450			RBD50	500	RBD10#	1000
RLBU60	600	RBAC860	800/600	RBAC10	1000/500			RBD60	600	RBD12#	1200
RLBU80#	800	RBAC940	900/400	RBAC160	1000/600			#2 x Doors		RBD80/1	800
RLBU90#	900	RBAC945	900/450	RBAC12	1200/600					RBD90/1	900
RLBU10#	1000									RBD10/1	1000
RLBU12#	1200										

Inc. 60x60mm Corner Post & Blanking Panel

**DRAWERLINE SINK BASE**

**CERAMIC SINK BASE**

**DRAWERLINE CORNER BASE**

**BUILT UNDER**

**2 DRAWER BASE**

**3 DRAWER BASE**

<b>H:720mm</b>	<b>CODE</b>	<b>WIDTH</b>	<b>H:460mm</b>	<b>CODE</b>	<b>WIDTH</b>	<b>H:720mm</b>	<b>CODE</b>	<b>WIDTH</b>	<b>H:720mm</b>	<b>CODE</b>	<b>WIDTH</b>	<b>H:720mm</b>	<b>CODE</b>	<b>WIDTH</b>	<b>H:720mm</b>	<b>CODE</b>	<b>WIDTH</b>
RBDF50	500	RBSU60	600	To suit a sink height of 260mm	RBDC830	800/300	RBDC140	1000/400	RBU060	600	RBUM60	600	RBD250	500	RBD350	500	
RBDF60	600				RBDC80	800/400	RBDC145	1000/450			175mm drawer & 110mm filler	RBD260	600	RBD360	600		
RBDF80#	800				RBDC845	800/450	RBDC10	1000/500				RBD280	800	RBD380	800		
RBDF90#	900				RBDC850	800/500	RBDC160	1000/600				RBD290	900	RBD390	900		
RBDF10#	1000				RBDC860	800/600	RBDC12	1200/600				RBD210	1000	RBD310	1000		
RBDD10*#	1000											2x355mm Drawers		1x140mm, 2x283mm Drawers			
RBDD12*#	1200											RBD350/175		RBD360/175			
*One working drawer												500		600			
#2 x Doors												RBD360/175		600			
												2x175mm, 1x355mm Drawers					

Inc. 60x60mm Corner Post & Blanking Panel

**4 DRAWER BASE**

**5 DRAWER BASE**

**LOW WALL**

**Diagonal Corner**

**Splayed**



**MEDIUM WALL**

<b>H:720mm</b>	<b>CODE</b>	<b>WIDTH</b>	<b>H:720mm</b>	<b>CODE</b>	<b>WIDTH</b>	<b>H:575mm</b>	<b>CODE</b>	<b>WIDTH</b>	<b>H:575mm</b>	<b>CODE</b>	<b>WIDTH</b>	<b>H:720mm</b>	<b>CODE</b>	<b>WIDTH</b>	
RBD450	500	RBD530	300	RWU30-5	300	R2WU60-5*	600	RCWD60-5	600x600	RAWU360-5	360	RWU26-7	260	R2WU60-7*	600
RBD460	600	RBD540	400	RWU40-5	400	RWU80-5#	800	Add 'X' to the end of the code for 350mm deep [650x650]		Add 'X' to the end of the code for 350mm deep		RWU30-7	300	RWU70-7#	700
RBD480	800	RBD545	450	RWU45-5	450	RWU90-5#	900					RWU35-7	350	RWU80-7#	800
RBD490	900	RBD550	500	RWU50-5	500	RWU10-5#	1000					RWU40-7	400	RWU90-7#	900
RBD410	1000	RBD560	600	RWU60-5	600	*No muntin [2 x 300 doors]						RWU45-7	450	RWU10-7#	1000
3x140mm, 1x283mm Drawers		RBD580	800			#2 x Doors						RWU50-7	500	*No muntin [2x300 doors]	
RBD450/175	500	RBD590	900									RWU60-7	600	#2x Doors	
RBD460/175	600	RBD510	1000											Add 'X' to the end of the code for 350mm deep	
4x175mm Drawers															





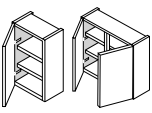

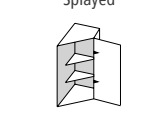
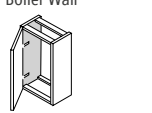
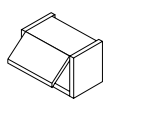

**MEDIUM WALL**

<b>H:720mm</b>	<b>CODE</b>	<b>WIDTH</b>	<b>H:720mm</b>	<b>CODE</b>	<b>WIDTH</b>	<b>H:720mm</b>	<b>CODE</b>	<b>WIDTH</b>	<b>H:720mm</b>	<b>CODE</b>	<b>WIDTH</b>	<b>H:720mm</b>	<b>CODE</b>	<b>WIDTH</b>	<b>H:720mm</b>	<b>CODE</b>	<b>WIDTH</b>
RWG50-7	500	RCWD60-7	600x600	RCWL60-7	600x600	RWUC260-7	600	RAWU360-7	360	RCDWU30-7	300x300	RMWU60-7	600	RBFWU50-7	500		
Add 'X' to the end of the code for 350mm deep		Add 'X' to the end of the code for 350mm deep [650x650]		Bi-fold hinge system		Inc. 60x60mm Corner Post		Add 'X' to the end of the code for 350mm deep		Add 'X' to the end of the code for 350mm deep		283mm flap, 110mm filler; Mechanism inc.		RBFWU60-7		600	
				Add 'X' to the end of the code for 350mm deep [650x650]								Add 'X' to the end of the code for 350mm deep		RBFWU80-7		800	
												RBFWU90-7		900			
												RBFWU10-7		1000			
												Mechanism inc.		Add 'X' to the end of the code for 350mm deep			

TALL WALL HORIZONTAL WALL

													
<p>H:900mm CODE WIDTH CODE WIDTH</p> <p><b>RWU30-9</b> 300 <b>R2WU60-9*</b> 600</p> <p><b>RWU40-9</b> 400 <b>RWU80-9*</b> 800</p> <p><b>RWU45-9</b> 450 <b>RWU90-9*</b> 900</p> <p><b>RWU50-9</b> 500 <b>RWU10-9*</b> 1000</p> <p><b>RWU60-9</b> 600</p> <p>*No muntin [2x300 doors] #2 x Doors</p>		<p>H:900mm CODE WIDTH</p> <p><b>RCWD60-9</b> 600x600</p> <p>Add 'X' to the end of the code for 350mm deep [650x650]</p>		<p>H:900mm CODE WIDTH</p> <p><b>RCWL60-9</b> 600x600</p> <p>Add 'X' to the end of the code for 350mm deep [650x650]</p>		<p>H:900mm CODE WIDTH</p> <p><b>RAWU360-9</b> 360</p> <p>Add 'X' to the end of the code for 350mm deep</p>		<p>H:900mm CODE WIDTH</p> <p><b>BWU6040-9</b> 600</p> <p>400mm Deep Flatpack</p>		<p>H:290mm CODE WIDTH</p> <p><b>RHWU5029</b> 500 <b>RHWU5036</b> 500</p> <p><b>RHWU6029</b> 600 <b>RHWU6036</b> 600</p> <p><b>RHWU8029</b> 800 <b>RHWU8036</b> 800</p> <p><b>RHWU9029</b> 900 <b>RHWU9036</b> 900</p> <p><b>RHWU1029</b> 1000 <b>RHWU1036</b> 1000</p> <p>Add 'X' to the end of the code for 350mm deep</p>			

OPEN WALL MIDI UNITS LARDER

																	
<p>H:290mm CODE WIDTH</p> <p><b>RWOS50-2</b> 500 <b>RWOS50-3</b> 500</p> <p><b>RWOS60-2</b> 600 <b>RWOS60-3</b> 600</p> <p><b>RWOS80-2</b> 800 <b>RWOS80-3</b> 800</p> <p><b>RWOS90-2</b> 900 <b>RWOS90-3</b> 900</p> <p><b>RWOS10-2</b> 1000 <b>RWOS10-3</b> 1000</p> <p>MFC Carcase</p>		<p>H:360mm CODE WIDTH</p> <p><b>RWOS50-3</b> 500</p> <p><b>RWOS60-3</b> 600</p> <p><b>RWOS80-3</b> 800</p> <p><b>RWOS90-3</b> 900</p> <p><b>RWOS10-3</b> 1000</p> <p>MFC Carcase</p>		<p>H:575mm CODE WIDTH</p> <p><b>RWOS30-5</b> 300</p> <p><b>RWOS40-5</b> 400</p> <p><b>RWOS45-5</b> 450</p> <p><b>RWOS50-5</b> 500</p> <p><b>RWOS60-5</b> 600</p> <p><b>RWOS80-5</b> 800</p> <p><b>RWOS90-5</b> 900</p> <p><b>RWOS10-5</b> 1000</p> <p>MFC Carcase</p>		<p>H:720mm CODE WIDTH</p> <p><b>RWOS30-7</b> 300</p> <p><b>RWOS40-7</b> 400</p> <p><b>RWOS45-7</b> 450</p> <p><b>RWOS50-7</b> 500</p> <p><b>RWOS60-7</b> 600</p> <p><b>RWOS80-7</b> 800</p> <p><b>RWOS90-7</b> 900</p> <p><b>RWOS10-7</b> 1000</p> <p>MFC Carcase</p>		<p>H:900mm CODE WIDTH</p> <p><b>RWOS30-9</b> 300</p> <p><b>RWOS40-9</b> 400</p> <p><b>RWOS45-9</b> 450</p> <p><b>RWOS50-9</b> 500</p> <p><b>RWOS60-9</b> 600</p> <p><b>RWOS80-9</b> 800</p> <p><b>RWOS90-9</b> 900</p> <p><b>RWOS10-9</b> 1000</p> <p>MFC Carcase</p>		<p>H:1210mm CODE WIDTH</p> <p><b>RDC1/50</b> 500</p> <p><b>RDC1/60</b> 600</p> <p>MFC Carcase</p>		<p>If 350mm deep carcase is required adjust code, e.g. RDC1/3550</p>		<p>H:1250mm CODE WIDTH</p> <p><b>RMLU60</b> 600</p> <p><b>RMA160</b> 600</p> <p><b>RMD060</b> 600</p> <p><b>RMOS60</b> 600</p>		<p>H:1970mm CODE WIDTH</p> <p><b>RTL30</b> 300</p> <p><b>RTL40</b> 400</p> <p><b>RTL50</b> 500</p> <p><b>TLU60</b> 600</p> <p><b>TLU80</b> 800</p> <p><b>TLU10</b> 1000</p>	



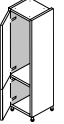
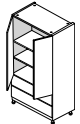
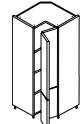
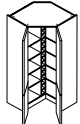
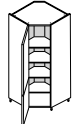
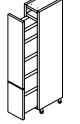
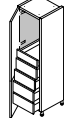
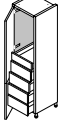

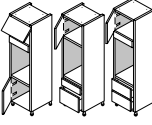
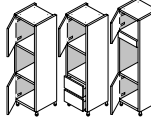
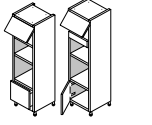
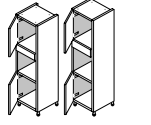
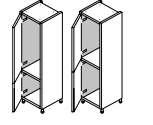
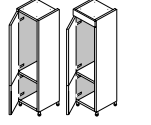
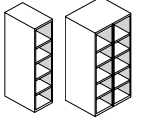

LARDER PULL-OUT LARDER INNER DRAWER LARDER

															
<p>H:2150mm CODE WIDTH</p> <p><b>RETL30</b> 300</p> <p><b>RETL40</b> 400</p> <p><b>RETL50</b> 500</p> <p><b>RETL60</b> 600</p> <p><b>ETLU80</b> 800</p> <p><b>ETLU10</b> 1000</p>		<p>H:1970mm CODE WIDTH</p> <p><b>TDLU80</b> 800</p> <p><b>TDLU10</b> 1000</p> <p>2x355 drawers</p>		<p>H:1970mm CODE WIDTH</p> <p><b>TCLU98</b> 985x985</p> <p><b>ETCLU98*</b> 985x985</p> <p>Bi-fold hinge system</p>		<p>*H:2150mm H:1970mm CODE WIDTH</p> <p><b>TDWIL114</b> 1144x1144</p> <p><b>ETDWIL114*</b> 1144x1144</p>		<p>H:1970mm CODE WIDTH</p> <p><b>TDCLU1003</b> 1003x1003</p> <p><b>ETDCLU1003*</b> 1003x1003</p>		<p>H:1970mm CODE WIDTH</p> <p><b>RTISPOL30</b> 300</p> <p><b>RTKPOL30</b> 300</p> <p>Standard Mechanism inc.</p> <p><b>RETISPOL30*</b> 300</p> <p><b>RETKPOL30*</b> 300</p> <p>Kessebohmer Mechanism</p>		<p>H:1970mm CODE WIDTH</p> <p><b>RTLID30</b> 300</p> <p><b>RTLID40</b> 400</p> <p><b>RTLID50</b> 500</p> <p><b>RTLID60</b> 600</p>		<p>H:2150mm CODE WIDTH</p> <p><b>RETLID30</b> 300</p> <p><b>RETLID40</b> 400</p> <p><b>RETLID50</b> 500</p> <p><b>RETLID60</b> 600</p> <p>1 x Standard, 4 x Deep drawers</p>	

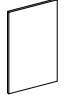



DOUBLE OVEN SINGLE OVEN SINGLE OVEN + COMPACT COMPACT TALL FRIDGE/FREEZER BOX WINE RACKS

													
<p>H:1970mm CODE WIDTH</p> <p><b>RTOHD60</b> 600</p> <p><b>RTOHD60</b> 600</p> <p><b>RETOHDD60*</b> 600</p>		<p>*H:2150mm H:1970mm CODE WIDTH</p> <p><b>RTOHS60</b> 600</p> <p><b>RTOHS60</b> 600</p> <p><b>RETOHS60*</b> 600</p>		<p>*H:2150mm H:1970mm CODE WIDTH</p> <p><b>RTOHC60</b> 600</p> <p><b>RETOHC60*</b> 600</p>		<p>*H:2150mm H:1970mm CODE WIDTH</p> <p><b>RTOHC60</b> 600</p> <p><b>RETOHC60*</b> 600</p>		<p>H:1970mm CODE WIDTH</p> <p><b>RTFF1/60</b> 600</p> <p><b>RTFF4/60*</b> 600</p> <p>*Doors undrilled</p> <p><b>RTFF1U/60#</b> 600</p> <p><b>RTFF4U/60#</b> 600</p> <p>#For door on door appliances</p>		<p>H:2150mm CODE WIDTH</p> <p><b>RETFF1/60</b> 600</p> <p><b>RETFF2/60</b> 600</p> <p><b>RETFF1U/60#</b> 600</p> <p><b>RETFF2U/60#</b> 600</p> <p>#For door on door appliances</p>		<p>W:125mm / W:250mm* CODE HEIGHT</p> <p><b>RWR125-7</b> 720</p> <p><b>RWR250-7*</b> 720</p> <p><b>RWR125-9</b> 900</p> <p><b>RWR250-9*</b> 900</p> <p><b>RWR125-1210</b> 1210</p> <p><b>WR125-1970</b> 1970</p> <p><b>WR250-1970*</b> 1970</p> <p>MFC Carcase</p> <p>If using as base order LEGSET</p>	

END SUPPORT PANELS CARCASE MFC PANELS CORNICE / PELMET PLINTH

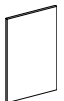
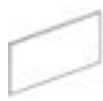
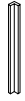
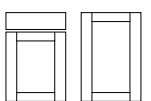
													
<p>H:900mm CODE WIDTH</p> <p><b>ESP</b> 600</p> <p><b>900/700</b> 700</p> <p>MFC Carcase</p>		<p>CODE WXH</p> <p><b>1970/300</b> 300x1970</p> <p><b>2150/560</b> 560x2150</p> <p><b>2350/660</b> 660x2350</p> <p><b>720/300</b> 300x720</p> <p><b>900/2000</b> 2000x900</p> <p><b>900/300</b> 300x900</p> <p>MFC Carcase</p>		<p>H:25mm CODE LENGTH</p> <p><b>PCM/BM</b> 3000</p> <p>Matt</p>		<p>H:25mm CODE WIDTH</p> <p><b>CCMS/BM</b> 322x322</p> <p>Matt</p> <p>Use in conjunction with PCM/BM</p>		<p>H:150mm CODE WIDTH</p> <p><b>PL</b> 2940</p> <p>MFC Carcase</p> <p><b>PL/BM</b> 3000</p> <p>Matt</p>		<p>H:150mm CODE WXD</p> <p><b>CPLS/BM</b> 275x535</p> <p>Matt</p> <p>Use in conjunction with PL/BM</p>		<p>CODE WIDTH</p> <p><b>PST</b> 3000</p>	

PLANT ON END PANELS FURNITURE ACCESSORIES INTEGRATED DOORS SPARE DOOR FITTINGS GENERAL ACCS.

													
<p>22mm CODE WXH</p> <p><b>2440/350/22BM</b> 350x2440</p> <p><b>2440/650/22BM</b> 650x2440</p> <p><b>900/650/22BM</b> 650x900</p> <p><b>910/1185/22BM</b> 1185x910</p> <p>Matt</p>		<p>22mm Breakfast Bar Panel CODE WXH</p> <p><b>900/2400/22BM</b> 2400x900</p> <p>Matt</p>		<p>H:715mm CODE WIDTH</p> <p><b>CP/BM</b> 60x60</p> <p>Matt</p>		<p>CODE WXH</p> <p><b>INT4571</b> 446x715</p> <p><b>INT6071</b> 596x715</p>		<p>Hinges [Hettich Soft Close] CODE</p> <p><b>SCHINGE90</b> 90 degree [Pair]</p> <p><b>SCHINGE170</b> 170 degree [Pair]</p>		<p>Stays [Blum Aventos] CODE</p> <p><b>BLSTAYHKS</b> HK-S stay [Pair]</p> <p>*[inc mounting brackets]</p>		<p>GENERAL ACCS. CODE</p> <p><b>STPWN</b> Set of 2</p> <p>Door Strapping Plates</p> <p><b>LEGSET</b> Set of 4</p> <p>Adjustable legs</p> <p><b>SACC</b> Pk 50</p> <p>14mm Self Adhesive Cover Caps</p> <p><b>PCC/BM</b> Painted care kit</p>	

Note: Furniture codes beginning with the letter 'R' are assembled (rigid), by removing the 'R' the units are supplied unassembled (flat-pack).

SLAB  
PRICE GROUP 2  
**KOLT**

*Special sizes available*  
contact us for further information

Colours Options [PG2]: Ash Marble, Copper Blend, Dark Oak, Graphite Blend, Grey Blend, Grey Marble, Lead Marble, Natural Oak and White Oak.



HI-LINE BASE

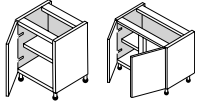

H:720mm CODE	WIDTH	CODE	WIDTH
RBA15	150	R2BA60*	600
RBA26	260	RBA70#	700
RBA30	300	RBA80#	800
RBA35	350	RBA90#	900
RBA40	400	RBA10#	1000
RBA45	450	RBA12#	1200
RBA50	500	*No muntin [2x300 doors]	
RBA60	600	# 2 x Doors	

Pull-Out

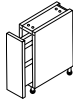

H:720mm CODE	WIDTH	H:720mm CODE	WIDTH
RBISPO15	150	RABA360	360
Standard Mechanism inc.			
RBKPO15	150		
Kesseböhmer Mechanism inc.			
RBKTP015	150		
Kesseböhmer Mechanism & Towel rail inc.			

Splayed

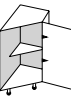

H:720mm CODE	WIDTH
RABA360	360

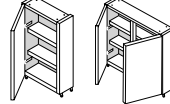

H:720mm CODE	WIDTH	CODE	WIDTH
RSBU30	300	RSBU70#	700
RSBU35	350	RSBU80#	800
RSBU40	400	RSBU90#	900
RSBU45	450	RSBU10#	1000
RSBU50	500	# 2 x Doors	
RSBU60	600		

LOW BASE

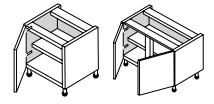

H:575mm CODE	WIDTH	CODE	WIDTH
RLBU30	300	RLBU80#	800
RLBU40	400	RLBU90#	900
RLBU45	450	RLBU10#	1000
RLBU50	500	RLBU12#	1200
RLBU60	600	# 2 x Doors	

HI-LINE CORNER BASE



H:720mm CODE	WIDTH	CODE	WIDTH
RBAC830	800/300	RBAC950	900/500
RBAC80	800/400	RBAC960	900/600
RBAC845	800/450	RBAC140	1000/400
RBAC850	800/500	RBAC145	1000/450
RBAC860	800/600	RBAC10	1000/500
RBAC940	900/400	RBAC160	1000/600
RBAC945	900/450	RBAC12	1200/600

Inc. 60x60mm Corner Post & Blanking Panel

'L' Shaped

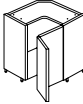

H:720mm CODE	WIDTH	H:720mm CODE	WIDTH
BAC90	900x900	CDA90	900x900
Bi-fold hinge system Flatpack			
Flatpack			

Diagonal



DRAWERLINE BASE

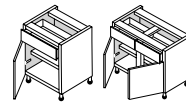

H:720mm CODE	WIDTH	CODE	WIDTH
RBD30	300	RBD80#	800
RBD40	400	RBD90#	900
RBD45	450	RBD10#	1000
RBD50	500	RBD12#	1200
RBD60	600	# 2 x Doors	

Single Top Drawer



H:720mm CODE	WIDTH	H:720mm CODE	WIDTH
RBD80/1	800	RBD90/1	900
RBD90/1	900	RBD10/1	1000

DRAWERLINE SINK BASE

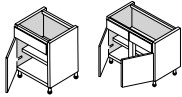

H:720mm CODE	WIDTH
RBDF50	500
RBDF60	600
RBDF80#	800
RBDF90#	900
RBDF10#	1000
RBDD10*#	1000
RBDD12*#	1200

\*One working drawer  
# 2 x Doors

CERAMIC SINK BASE



H:460mm CODE	WIDTH
RBSU60	600

To suit a sink height of 260mm

DRAWERLINE CORNER BASE



H:720mm CODE	WIDTH	CODE	WIDTH
RBDC830	800/300	RBDC140	1000/400
RBDC80	800/400	RBDC145	1000/450
RBDC845	800/450	RBDC10	1000/500
RBDC850	800/500	RBDC160	1000/600
RBDC860	800/600	RBDC12	1200/600

Inc. 60x60mm Corner Post & Blanking Panel

BUILT UNDER

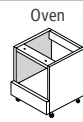

H:720mm CODE	WIDTH
RBUM60	600

Microwave



H:720mm CODE	WIDTH
RBUM60	600

175mm drawer & 110mm filler

2 DRAWER BASE



H:720mm CODE	WIDTH	H:720mm CODE	WIDTH
RBD250	500	RBD260	600
RBD280	800	RBD290	900
RBD210	1000	2x355mm Drawers	

3 DRAWER BASE

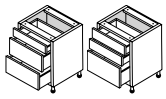

H:720mm CODE	WIDTH	CODE	WIDTH
RBD350	500	RBD450	500
RBD360	600	RBD460	600
RBD380	800	RBD480	800
RBD390	900	RBD490	900
RBD310	1000	RBD410	1000
1x140mm, 2x283mm Drawers			
RBD350/175	500	RBD450/175	500
RBD360/175	600	RBD460/175	600
2x175mm, 1x355mm Drawers			

4 DRAWER BASE

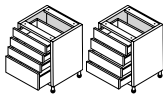

H:720mm CODE	WIDTH	CODE	WIDTH
RBD450	500	RBD460	600
RBD480	800	RBD490	900
RBD410	1000		
3x140mm, 1x283mm Drawers			
RBD450/175	500	RBD460/175	600
4x175mm Drawers			

5 DRAWER BASE



H:720mm CODE	WIDTH	CODE	WIDTH
RBD530	300	RBD540	400
RBD545	450	RBD550	500
RBD560	600	RBD580	800
RBD590	900	RBD510	1000
5x140mm Drawers			

LOW WALL

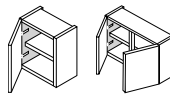

H:575mm CODE	WIDTH	CODE	WIDTH
RWU30-5	300	RWU80-5#	800
RWU40-5	400	RWU90-5#	900
RWU45-5	450	RWU10-5#	1000
RWU50-5	500	*No muntin [2 x 300 doors]	
RWU60-5	600	# 2 x Doors	

Add 'X' to the end of the code for 350mm deep

Diagonal Corner



H:575mm CODE	WIDTH
RCWD60-5	600x600

Add 'X' to the end of the code for 350mm deep [650x650]

Splayed



H:575mm CODE	WIDTH
RAWU360-5	360

Add 'X' to the end of the code for 350mm deep

MEDIUM WALL

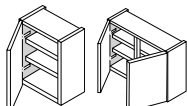

H:720mm CODE	WIDTH	CODE	WIDTH
RWU26-7	260	R2WU60-7*	600
RWU30-7	300	RWU70-7#	700
RWU35-7	350	RWU80-7#	800
RWU40-7	400	RWU90-7#	900
RWU45-7	450	RWU10-7#	1000
RWU50-7	500	*No muntin [2x300 doors]	
RWU60-7	600	# 2x Doors	

Add 'X' to the end of the code for 350mm deep

Diagonal Corner



H:720mm CODE	WIDTH
RCWD60-7	600x600

Add 'X' to the end of the code for 350mm deep [650x650]

'L' Shaped Corner



H:720mm CODE	WIDTH
RCWL60-7	600x600

Bi-fold hinge system  
Add 'X' to the end of the code for 350mm deep [650x650]

Conventional Corner



H:720mm CODE	WIDTH
RCWC260-7	600

Inc. 60x60mm Corner Post  
Add 'X' to the end of the code for 350mm deep

Splayed



H:720mm CODE	WIDTH
RAWU360-7	360

Add 'X' to the end of the code for 350mm deep

Microwave Wall



H:720mm CODE	WIDTH
RMWU60-7	600

283mm flap, 110mm filler; Mechanism inc.  
Add 'X' to the end of the code for 350mm deep

Bi-Fold



H:720mm CODE	WIDTH
RBFWU50-7	500
RBFWU60-7	600
RBFWU80-7	800
RBFWU90-7	900
RBFWU10-7	1000

Mechanism inc.  
Add 'X' to the end of the code for 350mm deep

TALL WALL

HORIZONTAL WALL

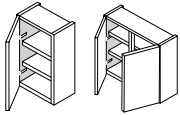

Diagonal Corner

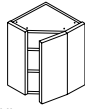

'L' Shaped Corner

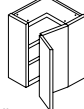

Splayed

Boiler Wall

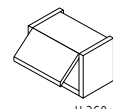
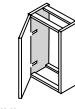

H:900mm CODE	WIDTH	CODE	WIDTH
<b>RWU30-9</b>	300	<b>R2WU60-9*</b>	600
<b>RWU40-9</b>	400	<b>RWU80-9*</b>	800
<b>RWU45-9</b>	450	<b>RWU90-9*</b>	900
<b>RWU50-9</b>	500	<b>RWU10-9*</b>	1000
<b>RWU60-9</b>	600		

H:900mm CODE	WIDTH	H:900mm CODE	WIDTH
<b>RCWD60-9</b>	600x600	<b>RCWL60-9</b>	600x600

Add 'X' to the end of the code for 350mm deep [650x650]

H:900mm CODE	WIDTH	H:900mm CODE	WIDTH
<b>RAWU360-9</b>	360	<b>BWU6040-9</b>	600

400mm Deep Flatpack

H:290mm CODE	WIDTH	H:360mm CODE	WIDTH
<b>RHWU5029</b>	500	<b>RHWU5036</b>	500
<b>RHWU6029</b>	600	<b>RHWU6036</b>	600
<b>RHWU8029</b>	800	<b>RHWU8036</b>	800
<b>RHWU9029</b>	900	<b>RHWU9036</b>	900
<b>RHWU1029</b>	1000	<b>RHWU1036</b>	1000

\*No muntin [2x300 doors]  
#2 x Doors

Add 'X' to the end of the code for 350mm deep

Add 'X' to the end of the code for 350mm deep

OPEN WALL



H:290mm CODE	WIDTH
<b>RWOS50-2</b>	500
<b>RWOS60-2</b>	600
<b>RWOS80-2</b>	800
<b>RWOS90-2</b>	900
<b>RWOS10-2</b>	1000

MFC Carcase

If 350mm deep carcase is required adjust code, e.g. RWOS1035-2

H:360mm CODE	WIDTH
<b>RWOS50-3</b>	500
<b>RWOS60-3</b>	600
<b>RWOS80-3</b>	800
<b>RWOS90-3</b>	900
<b>RWOS10-3</b>	1000

MFC Carcase

If 350mm deep carcase is required adjust code, e.g. RWOS1035-3

H:575mm CODE	WIDTH
<b>RWOS30-5</b>	300
<b>RWOS40-5</b>	400
<b>RWOS45-5</b>	450
<b>RWOS50-5</b>	500
<b>RWOS60-5</b>	600
<b>RWOS80-5</b>	800
<b>RWOS90-5</b>	900
<b>RWOS10-5</b>	1000

MFC Carcase

If 350mm deep carcase is required adjust code, e.g. RWOS1035-5

H:720mm CODE	WIDTH
<b>RWOS30-7</b>	300
<b>RWOS40-7</b>	400
<b>RWOS45-7</b>	450
<b>RWOS50-7</b>	500
<b>RWOS60-7</b>	600
<b>RWOS80-7</b>	800
<b>RWOS90-7</b>	900
<b>RWOS10-7</b>	1000

MFC Carcase

If 350mm deep carcase is required adjust code, e.g. RWOS1035-7

H:900mm CODE	WIDTH
<b>RWOS30-9</b>	300
<b>RWOS40-9</b>	400
<b>RWOS45-9</b>	450
<b>RWOS50-9</b>	500
<b>RWOS60-9</b>	600
<b>RWOS80-9</b>	800
<b>RWOS90-9</b>	900
<b>RWOS10-9</b>	1000

MFC Carcase

If 350mm deep carcase is required adjust code, e.g. RWOS1035-9

If 350mm deep carcase is required adjust code, e.g. RDC1/3550

MIDI UNITS

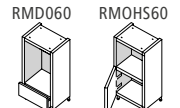
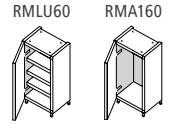

H:1250mm CODE	WIDTH
<b>RMLU60</b>	600
<b>RMA160</b>	600
<b>RMD060</b>	600
<b>RMOHS60</b>	600

LARDER

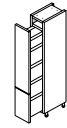
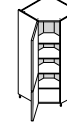
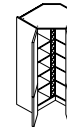
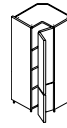
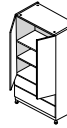
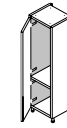
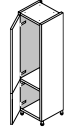
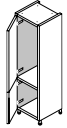

H:1970mm CODE	WIDTH
<b>RTLU30</b>	300
<b>RTLU40</b>	400
<b>RTLU50</b>	500
<b>RTLU60</b>	600
<b>TLU80</b>	800
<b>TLU10</b>	1000

H:2150mm CODE	WIDTH
<b>RETLU30</b>	300
<b>RETLU40</b>	400
<b>RETLU50</b>	500
<b>RETLU60</b>	600
<b>ETLU80</b>	800
<b>ETLU10</b>	1000
<b>RETLU60/1*</b>	600

\*715mm bottom, 1425mm top door

H:1970mm CODE	WIDTH
<b>RTLUSD50</b>	500
<b>RTLUSD60</b>	600

H:1970mm CODE	WIDTH
<b>TDLU80</b>	800
<b>TDLU10</b>	1000

2x355 drawers

H:1970mm CODE	*H:2150mm WIDTH
<b>TCLU98</b>	985x985
<b>ETCLU98*</b>	985x985

Bi-fold hinge system

H:1970mm CODE	*H:2150mm WIDTH
<b>TDWIL1144</b>	1144x1144
<b>ETDWIL1144*</b>	1144x1144

H:1970mm CODE	*H:2150mm WIDTH
<b>TDCLU1003</b>	1003x1003
<b>ETDCLU1003*</b>	1003x1003

H:1970mm CODE	*H:2150mm WIDTH
<b>RTISPOL30</b>	300
<b>RTKPOL30</b>	300

Standard Mechanism inc.  
**RETISPOL30\*** 300  
**RETKPOL30\*** 300  
Kesseböhmer Mechanism inc.

INNER DRAWER LARDER

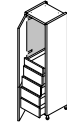
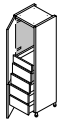

H:1970mm CODE	WIDTH
<b>RTLID30</b>	300
<b>RTLID40</b>	400
<b>RTLID50</b>	500
<b>RTLID60</b>	600

1 x Standard, 4 x Deep drawers

H:2150mm CODE	WIDTH
<b>RETLID30</b>	300
<b>RETLID40</b>	400
<b>RETLID50</b>	500
<b>RETLID60</b>	600

1 x Standard, 4 x Deep drawers

DOUBLE OVEN

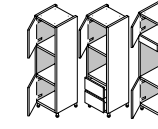
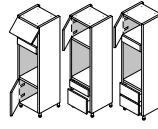

H:1970mm CODE	*H:2150mm WIDTH
<b>ROTOHD60</b>	600
<b>ROTOHDD60</b>	600
<b>RETOHDD60*</b>	600

H:1970mm CODE	*H:2150mm WIDTH
<b>ROTOHS60</b>	600
<b>ROTOHSD60</b>	600
<b>RETOHS60*</b>	600

SINGLE OVEN + COMPACT



H:1970mm CODE	*H:2150mm WIDTH
<b>ROTOHSC60</b>	600
<b>RETOHSC60*</b>	600

COMPACT

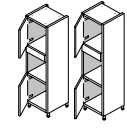

H:1970mm CODE	*H:2150mm WIDTH
<b>ROTOHC60</b>	600
<b>RETOHC60*</b>	600

TALL FRIDGE/FREEZER

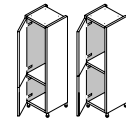

H:1970mm CODE	WIDTH
<b>RTFF1/60</b>	600
<b>RTFF4/60*</b>	600

\*Doors undrilled  
**RTFF1U/60#** 600  
**RTFF4U/60#** 600  
# For door on door appliances

TALL FRIDGE/FREEZER

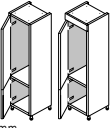

H:2150mm CODE	WIDTH
<b>RETFF1/60</b>	600
<b>RETFF2/60</b>	600
<b>RETFF3/60*</b>	600
<b>RETFF1U/60*</b>	600
<b>RETFF2U/60*</b>	600
<b>RETFF3U/60*</b>	600

#For door on door appliances  
\*715mm bottom, 1425mm top door

BOX WINE RACKS

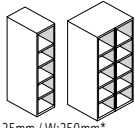

W:125mm / W:250mm* CODE	HEIGHT
<b>RWR125-7</b>	720
<b>RWR250-7*</b>	720
<b>RWR125-9</b>	900
<b>RWR250-9*</b>	900
<b>RWR125-1210</b>	1210
<b>WR125-1970</b>	1970
<b>WR250-1970*</b>	1970

MFC Carcase  
If using as base order LEGSET

END SUPPORT PANELS



H:900mm CODE	WIDTH
<b>ESP</b>	600
<b>900/700</b>	700

MFC Carcase

CARCASE MFC PANELS

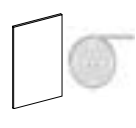

CODE	WXH
<b>1970/300</b>	300x1970
<b>2150/560</b>	560x2150
<b>2350/660</b>	660x2350
<b>720/300</b>	300x720
<b>900/2000</b>	2000x900
<b>900/300</b>	300x900

MFC Carcase

CORNICE / PELMET

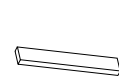

H:18mm CODE	D:70mm LENGTH
<b>CM/MK</b>	2700

Door Finish

PLINTH



H:150mm CODE	WIDTH
<b>PL</b>	2940

MFC Carcase  
**PL/MK** 2700  
Door Finish

PLINTH

Clear Sealing Strip



CODE	WIDTH
<b>PST</b>	3000

PLANT ON END PANELS

18mm



CODE	WXH
<b>2400/650/18MK</b>	650x2400
<b>900/650/18MK</b>	650x900
<b>940/375/18MK</b>	375x940

Door Finish

18mm Breakfast Bar Panel

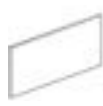

CODE	WXH
<b>900/1200/18MK</b>	1200x900

Door Finish

FURNITURE ACCS.

Corner Post [Spare]



H:715mm CODE	WIDTH
<b>CP/MK</b>	146

Flat panel for on site conversion  
Door Finish

INTEGRATED DOORS

Undrilled

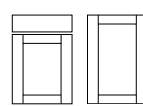

CODE	WXH
<b>INT4571</b>	446x715
<b>INT6071</b>	596x715

SPARE DOOR FITTINGS

Hinges [Hettich Soft Close]

CODE
<b>SCHINGE90</b>
90 degree [Pair]
<b>SCHINGE170</b>
170 degree [Pair]

Stays [Blum Aventos]  
**BLSTAYHK5**  
HK-5 stay [Pair]  
\* [inc mounting brackets]

GENERAL ACCS.

<b>STPWN</b>	Set of 2
Door Strapping Plates	
<b>LEGSET</b>	Set of 4
Adjustable legs	
<b>SACC</b>	Pk 50
14mm Self Adhesive Cover Caps	
<b>PCCB/M</b>	
Painted care kit	



SLAB  
PRICE GROUP 6 + 7  
**LANGLEY**  
PAINT TO ORDER

 Special sizes available  
contact us for further information

Colour Options [PG6]: Auburn, Black, Bone, Dusty Rose, Cashmere, Coal, Cotton, Fern, Forest, Mink, Mist, Moss, Navy, Putty, Riptide, Sea Salt, Smoke, Space, Thyme and Twilight.

Bespoke Colour Option [PG7]



HI-LINE BASE LOW BASE HI-LINE CORNER BASE

Pull-Out				Splayed		Shallow Base [300mm deep]		L' Shaped		Diagonal			
H:720mm CODE	WIDTH	CODE	WIDTH	H:720mm CODE	WIDTH	H:720mm CODE	WIDTH	H:720mm CODE	WIDTH	H:720mm CODE	WIDTH		
RBA15	150	R2BA60*	600	RBISPO15	150	RSBU30	300	RLBU30	300	BAC90	900x900	CDA90	900x900
RBA30	300	RB A70#	700	Standard Mechanism inc.		RSBU35	350	RLBU40	400	Bi-fold hinge system		Flat pack	
RBA35	350	RBA80#	800	Kesseböhmer Mechanism inc.		RSBU40	400	RLBU45	450	Flat pack			
RBA40	400	RBA90#	900	RBKTP015 150		RSBU45	450	RLBU50	500				
RBA45	450	RBA10#	1000	Kesseböhmer Mechanism & Towel rail inc.		RSBU50	500	RLBU60	600				
RBA50	500	RBA12#	1200			RSBU60	600	RLBU80#	800				
RBA60	600	*No muntin [2x300 doors] # 2 x Doors				RSBU70#	700	RLBU90#	900				
						RSBU80#	800	RLBU10#	1000				
						RSBU90#	900	RLBU12#	1200				
						RSBU10#	1000	# 2 x Doors					

HI-LINE CORNER BASE DRAWERLINE BASE DRAWERLINE SINK BASE CERAMIC SINK BASE DRAWERLINE CORNER BASE BUILT UNDER

Single Top Drawer				DRAWERLINE SINK BASE		CERAMIC SINK BASE		DRAWERLINE CORNER BASE		BUILT UNDER			
H:720mm CODE	WIDTH	CODE	WIDTH	H:720mm CODE	WIDTH	H:460mm CODE	WIDTH	H:720mm CODE	WIDTH	H:720mm CODE	WIDTH		
RBAC830	800/300	RBAC950	900/500	RBD30	300	RBD80/1	800	RBSU60	600x460	RBDC830	800/300	RBU060	600
RBAC80	800/400	RBAC960	900/600	RBD40	400	RBD90/1	900	To suit a sink height of 260mm		RBDC80	800/400	Oven	
RBAC845	800/450	RBAC140	1000/400	RBD45	450	RBD10/1	1000			RBDC845	800/450	Microwave	
RBAC850	800/500	RBAC145	1000/450	RBD50	500					RBDC850	800/500	H:720mm CODE WIDTH	
RBAC860	800/600	RBAC10	1000/500	RBD60	600	RBDF50	500			RBDC860	800/600	RBUM60 600	
RBAC940	900/400	RBAC160	1000/600	RBD80#	800	RBDF60	600			RBDC140	1000/400	175mm drawer & 110mm filler	
RBAC945	900/450	RBAC12	1200/600	RBD80#	800	RBDF80#	800			RBDC145	1000/450		
Inc. Corner Post & Blanking Panel				RBD90#	900	RBDF90#	900			RBDC10	1000/500		
				RBD10#	1000	RBDF10#	1000			RBDC160	1000/600		
				RBD12#	1200	RBDD10*#	1000			RBDC12	1200/600		
						RBDD12*#	1200			Inc. Corner Post & Blanking Panel			
						*One working drawer # 2 x Doors							

2 DRAWER BASE 3 DRAWER BASE 4 DRAWER BASE 5 DRAWER BASE LOW WALL

2 DRAWER BASE				3 DRAWER BASE				4 DRAWER BASE				5 DRAWER BASE				LOW WALL			
H:720mm CODE	WIDTH	CODE	WIDTH	H:720mm CODE	WIDTH	CODE	WIDTH	H:720mm CODE	WIDTH	CODE	WIDTH	H:720mm CODE	WIDTH	H:575mm CODE	WIDTH	CODE	WIDTH		
RBD250	500	RBD350	500	RBD260	600	RBD360	600	RBD280	800	RBD380	800	RBD290	900	RBD390	900	RWU30-5	300	RWU80-5#	800
RBD210	1000	RBD310	1000	2x355mm Drawers		1x140mm, 2x283mm Drawers		RBD450	500	RBD460	600	RBD480	800	RBD490	900	RWU40-5	400	RWU90-5#	900
								RBD410	1000	RBD420	1000	RBD430	1000	RBD440	1000	RWU45-5	450	RWU10-5#	1000
								RBD450/175	500	RBD460/175	600	RBD470	1000	RBD480	1000	RWU50-5	500	*No muntin # 2 x Doors	
								2 x 175mm, 1x355mm Drawers		4x175mm Drawers		5x140mm Drawers		RWU60-5	600	Add 'X' to the end of the code for 350mm deep			
														R2WU60-5*#	600				

MEDIUM WALL

Bi-Fold				Glazed Door				Diagonal Corner				'L' Shaped Corner				Conventional Corner				Splayed				Microwave Wall			
H:720mm CODE	WIDTH	CODE	WIDTH	D:300mm CODE	WIDTH	H:720mm CODE	WIDTH	D:300mm CODE	WIDTH	H:720mm CODE	WIDTH	D:300mm CODE	WIDTH	H:720mm CODE	WIDTH	D:300mm CODE	WIDTH										
RBFWU50-7	500	R2WU60-7*#	600	RWU30-7	300	RWGR50-7*	500	RCWD60-7	600x600	RCWL60-7	600x600	RWUC60-7	600	RAWU360-7	360	RMWU60-7	600										
RBFWU60-7	600	RWU70-7#	700	RWU35-7	350	RWGR10-7*	1000	Add 'X' to the end of the code for 350mm deep [650x650]		Bi-fold hinge system		Inc. Corner Post		Add 'X' to the end of the code for 350mm deep [650x650]		283mm flap, 110mm filler; Mechanism inc.		Add 'X' to the end of the code for 350mm deep									
RBFWU80-7	800	RWU80-7#	800	RWU40-7	400	*Reeded glass																					
RBFWU90-7	900	RWU90-7#	900	RWU45-7	450	Add 'X' to the end of the code for 350mm deep																					
RBFWU10-7	1000	RWU10-7#	1000	RWU50-7	500	*No muntin [2x300 doors] # 2 x Doors																					
				RWU60-7*#	600	Add 'X' to the end of the code for 350mm deep																					

MEDIUM WALL TALL WALL

Bi-Fold				Glazed Door				Diagonal Corner				Splayed				Boiler Wall			
H:720mm CODE	WIDTH	CODE	WIDTH	D:300mm CODE	WIDTH	H:900mm CODE	WIDTH	D:300mm CODE	WIDTH	H:900mm CODE	WIDTH	D:300mm CODE	WIDTH	H:900mm CODE	WIDTH	D:300mm CODE	WIDTH		
RBFWU50-7	500	RWU30-9	300	R2WU60-9*#	600	RWGR50-9*	500	RCWD60-9	600x600	RCWL60-9	600x600	RWUC60-9	600	RAWU360-9	360	BMWU6040-9	600		
RBFWU60-7	600	RWU40-9	400	RWU80-9#	800	RWGR10-9*	1000	Add 'X' to the end of the code for 350mm deep		Bi-fold hinge system		Inc. Corner Post		Add 'X' to the end of the code for 350mm deep		400mm Deep		Flat pack	
RBFWU80-7	800	RWU45-9	450	RWU90-9#	900	*Reeded glass													
RBFWU90-7	900	RWU50-9	500	RWU10-9#	1000	Add 'X' to the end of the code for 350mm deep													
RBFWU10-7	1000	RWU60-9	600	*No muntin [2x300 doors] # 2 x Doors		Add 'X' to the end of the code for 350mm deep													

HORIZONTAL WALL



H:290mm		H:360mm	
CODE	WIDTH	CODE	WIDTH
RHWU5029	500	RHWU5036	500
RHWU6029	600	RHWU6036	600
RHWU8029	800	RHWU8036	800
RHWU9029	900	RHWU1036	900
RHWU1029	1000	RHWU1036	1000

Add 'X' to the end of the code for 350mm deep

GLAZED DRESSER



CODE	WIDTH
RDRR1/50*	500

\*Reeded glass  
1 door  
Add 'X' to the end of the code for 350mm deep

OPEN WALL



CODE	WIDTH
RWOS50-2	500
RWOS60-2	600
RWOS80-2	800
RWOS90-2	900
RWOS10-2	1000

MFC Carcase

If 350mm deep carcase is required adjust code, e.g RWOS1035-2



CODE	WIDTH
RWOS50-3	500
RWOS60-3	600
RWOS80-3	800
RWOS90-3	900
RWOS10-3	1000

MFC Carcase

If 350mm deep carcase is required adjust code, e.g RWOS1035-3



CODE	WIDTH
RWOS30-5	300
RWOS40-5	400
RWOS45-5	450
RWOS50-5	500
RWOS60-5	600
RWOS80-5	800
RWOS90-5	900
RWOS10-5	1000

MFC Carcase

If 350mm deep carcase is required adjust code, e.g RWOS1035-5



CODE	WIDTH
RWOS30-7	300
RWOS40-7	400
RWOS45-7	450
RWOS50-7	500
RWOS60-7	600
RWOS80-7	800
RWOS90-7	900
RWOS10-7	1000

MFC Carcase

If 350mm deep carcase is required adjust code, e.g RWOS1035-7



CODE	WIDTH
RWOS30-9	300
RWOS40-9	400
RWOS45-9	450
RWOS50-9	500
RWOS60-9	600
RWOS80-9	800
RWOS90-9	900
RWOS10-9	1000
RDC1/50	500
RDC1/60	600

MFC Carcase

If 350mm deep carcase is required adjust code, e.g RWOS1035-9

MIDI UNITS

RMLU60 RMA160 RMD060 RMOH560

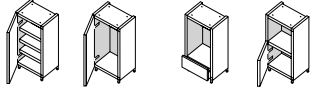

CODE	WIDTH	CODE	WIDTH
RMLU60	600	RMD060	600
RMA160	600	RMOH560	600

LARDER



CODE	WIDTH	CODE	WIDTH	CODE	WIDTH	CODE	WIDTH	CODE	WIDTH
RTL30	300	RETLU30	300	RTL50	500	RETLU50	500	RTL60	600
RTL40	400	RETLU40	400	RTL80	800	RETLU80	800	TLU10	1000
RTL50	500	RETLU50	500	RTL60	600	ETLU80	800	ETLU10	1000

\*H:1970mm  
\*H:2150mm  
\*H:2150mm  
\*H:2150mm

LARDER

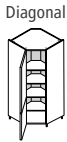

CODE	WIDTH	CODE	WIDTH
TDCLU1003	1003x1003	ETDCLU1003*	1003x1003

PULL-OUT LARDER

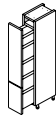

CODE	WIDTH	CODE	WIDTH
RTISPOL30	300	RTKPOL30	300
RETISPOL30*	300	RETKPOL30*	300

Standard Mechanism inc.  
Kesseböhmer Mechanism inc.

INNER DRAWER LARDER

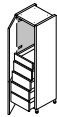

CODE	WIDTH	CODE	WIDTH
RTLID30	300	RTLID40	400
RTLID50	500	RTLID60	600

1 x Standard, 4 x Deep drawers

DOUBLE OVEN

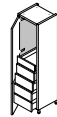

CODE	WIDTH	CODE	WIDTH
RETLD30	300	RETLD40	400
RETLD50	500	RETLD60	600

DOUBLE OVEN

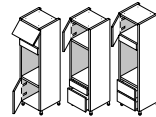

CODE	WIDTH	CODE	WIDTH
RTOHD60	600	RTOHDD60	600
RETOHDD60*	600		

2x355mm drawers

SINGLE OVEN

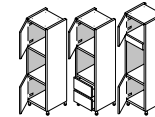

CODE	WIDTH	CODE	WIDTH
RTOHS60	600	RTOHSD60	600
RETOHS60*	600		

Bi-fold hinge system

SINGLE OVEN + COMPACT



CODE	WIDTH	CODE	WIDTH
RTOHSC60	600	RETOHSC60*	600

COMPACT

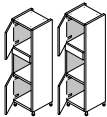

CODE	WIDTH	CODE	WIDTH
RTOHC60	600	RETOHC60*	600

TALL FRIDGE/FREEZER

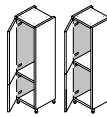

CODE	WIDTH	CODE	WIDTH
RTFF1/60	600	RTFF4/60*	600
RTFF1U/60#	600	RTFF4U/60#	600

\*Doors undrilled  
# For door on door appliances

BOX WINE RACKS

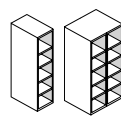

CODE	WIDTH	CODE	WIDTH
RETFF1/60	600	RETFF2/60	600
RETFF1U/60#	600	RETFF2U/60#	600

# For door on door appliances

BOX WINE RACKS

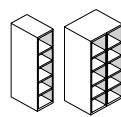

CODE	HEIGHT	CODE	HEIGHT
RWR125-7	720	RWR250-7*	720
RWR125-9	900	RWR250-9*	900
RWR125-1210	1210	WR125-1970	1970
WR250-1970*	1970		

If using as base order LEGSET.  
MFC Carcase

END SUPPORT PANELS



CODE	WIDTH	CODE	WIDTH
ESP	600	900/700	700

MFC Carcase

CARCASE MFC PANELS

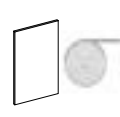

CODE	WXH	CODE	WXH
1970/300	300x1970	2150/560	560x2150
2350/660	660x2350	720/300	300x720
900/2000	2000x900	900/300	300x900

MFC Carcase  
UG/\*ET 1000x22  
\*Un-Glued 1m Carcase Edging

CORNICE

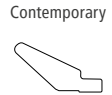

CODE	WIDTH
COC/B	3000

Contemporary

COMBI



CODE	LENGTH
PCM/B	3000

CODE	WIDTH
CP/B**10	146

Flat Panel for on site conversion

PLINTH



CODE	WIDTH
PL	2940

Melamine [Carcase MFC]  
PL/B\* 3000  
Door finish  
VF/B 3000  
Veneered Filler  
Finished on both long edges - can be used as plinth  
\*Includes PST sealing strip

Clear Sealing Strip



CODE	WIDTH
PST	3000

Decorative Plinth



CODE	WIDTH
DECPL/B	3000

Door Finish

PLANT ON END PANELS



CODE	WXH	CODE	WXH
2440/350/22B	350x2440	900/1170/22B	1170x900
2440/650/22B	650x2440	900/910/22B	910x900
900/650/22B	650x900		
950/350/22B	350x950		

Painted

22mm Plain



CODE	WXH	CODE	WXH
900/1170/22B	1170x900	900/2000/22B	2000x900
900/910/22B	910x900		

Painted

22mm Plain Breakfast Bar Back Panel



CODE	WXH
900/2000/22B	2000x900

Painted

FURNITURE ACCESSORIES

Corner Post [Spare]



CODE	WIDTH
CP/B**10	146

Flat Panel for on site conversion

Mantle Shelf



CODE	WXD
MS/B	2400x200

Specify length required - can be made to size

Decorative Corbel [Single]



CODE	WXD
COR/B	107x95

Door Hung Spice Rack



CODE	WXD
DHSR/BNO	350x106

Undrilled



CODE	WXH
INT4571	446x715
INT6071	596x715

WINE CAB DOORS



CODE	WXH
WCD607	715x596

To suit Caple W1616  
WCD60179 1790x596  
To suit Caple WC1800 wine cabinet

SPARE DOOR FITTINGS

Hinges [Hettich Soft Close]

CODE	WXH
SCHINGE90	90 degree [Pair]
SCHINGE170	170 degree [Pair]

CODE	WXH
BLSTAYHKS	HK-S stay [Pair]

\*[Incl mounting brackets]

GENERAL ACCS.

CODE	DESCRIPTION
STPWN	Set of 2 Door Strapping Plates
LEGSET	Set of 4 Adjustable legs
SACC	Pk 50 14mm Self Adhesive Cover Caps
PCC/B	Painted Care Kit
TOUCH/B	Touch Up Paint 500ml

SLAB  
PRICE GROUP 2  
**LYDE**

Special sizes available  
contact us for further information

Colours Options [PG2]: Dust Grey, Graphite, Grey, Savanna and White.



HI-LINE BASE      Pull-Out      Curved Door      LOW BASE      HI-LINE CORNER BASE

H:720mm CODE	WIDTH	CODE	WIDTH	H:720mm CODE	WIDTH	H:720mm CODE	WIDTH	H:720mm CODE	WIDTH	H:720mm CODE	WIDTH	H:720mm CODE	WIDTH		
RBA15	150	R2BA60*	600	RBISPO15	150	RCDBA30	300x300	RSBU30	300	RLBU30	300	RBAC830	800/300	RBAC950	900/500
RBA26	260	RBA70#	700	Standard Mechanism inc.				RSBU35	350	RLBU40	400	RBAC80	800/400	RBAC960	900/600
RBA30	300	RBA80#	800	RBKPO15	150			RSBU40	400	RLBU45	450	RBAC845	800/450	RBAC140	1000/400
RBA35	350	RBA90#	900	Kesseböhmer Mechanism inc.				RSBU45	450	RLBU50	500	RBAC850	800/500	RBAC145	1000/450
RBA40	400	RBA10#	1000	RBKTPO15	150			RSBU50	500	RLBU60	600	RBAC860	800/600	RBAC10	1000/500
RBA45	450	RBA12#	1200	Kesseböhmer Mechanism & Towel rail inc.				RSBU60	600	RLBU80#	800	RBAC940	900/400	RBAC160	1000/600
RBA50	500	*No muntin [2x300 doors]						RSBU70#	700	RLBU90#	900	RBAC945	900/450	RBAC12	1200/600
RBA60	600	# 2 x Doors						RSBU80#	800	RLBU10#	1000	Inc. 60x60mm Corner Post & Blanking Panel			
								RSBU90#	900	RLBU12#	1200				
								RSBU10#	1000	# 2 x Doors					

HI-LINE CORNER BASE      DRAWERLINE BASE      DRAWERLINE SINK BASE

H:720mm CODE	WIDTH	H:720mm CODE	WIDTH	H:720mm CODE	WIDTH	H:720mm CODE	WIDTH	H:720mm CODE	WIDTH	H:720mm CODE	WIDTH		
BAC90	900x900	CDA90	900x900	RBD30	300	RBD80#	800	RBD80/1	800	RBD50	500	RBD10#	1000
Bi-fold hinge system Flatpack		Flatpack		RBD40	400	RBD90#	900	RBD90/1	900	RBD60	600	RBD10*#	1000
				RBD45	450	RBD10#	1000	RBD10/1	1000	RBD80#	800	RBD12*#	1200
				RBD50	500	RBD12#	1200			RBD90#	900	*One working drawer # 2 x Doors	
				RBD60	600	# 2 x Doors				RBD90#	900		

CERAMIC SINK BASE      DRAWERLINE CORNER BASE      BUILT UNDER      2 DRAWER BASE      3 DRAWER BASE

H:460mm CODE	WIDTH	H:720mm CODE	WIDTH	H:720mm CODE	WIDTH	H:720mm CODE	WIDTH	H:720mm CODE	WIDTH	H:720mm CODE	WIDTH		
RBSU60	600	RBDC830	800/300	RBDC140	1000/400	RBU060	600	RBUM60	600	RBD250	500	RB350	500
To suit a sink height of 260mm		RBDC80	800/400	RBDC145	1000/450			175mm drawer & 110mm filler		RB260	600	RB360	600
		RBDC845	800/450	RBDC10	1000/500					RB280	800	RB380	800
		RBDC850	800/500	RBDC160	1000/600					RB290	900	RB390	900
		RBDC860	800/600	RBDC12	1200/600					RB210	1000	RB310	1000
		Inc. 60x60mm Corner Post & Blanking Panel								2x355mm Drawers		1x140mm, 2x283mm Drawers	
												RB350/175 500	
												RB360/175 600	
												2x175mm, 1x355mm Drawers	

4 DRAWER BASE      5 DRAWER BASE      LOW WALL      MEDIUM WALL

H:720mm CODE	WIDTH	H:720mm CODE	WIDTH	H:575mm CODE	WIDTH	H:720mm CODE	WIDTH	H:720mm CODE	WIDTH	H:720mm CODE	WIDTH		
RB450	500	RB530	300	RWU30-5	300	RCWD60-5	600x600	RWU26-7	260	RWU60-7*	600	RCWD60-7	600x600
RB460	600	RB540	400	RWU40-5	400	Add 'X' to the end of the code for 350mm deep [650x650]		RWU30-7	300	RWU70-7#	700	Add 'X' to the end of the code for 350mm deep [650x650]	
RB480	800	RB545	450	RWU45-5	450			RWU35-7	350	RWU80-7#	800		
RB490	900	RB550	500	RWU50-5	500			RWU40-7	400	RWU90-7#	900		
RB410	1000	RB560	600	RWU60-5	600			RWU45-7	450	RWU10-7#	1000		
3x140mm, 1x283mm Drawers		RB580	800	R2WU60-5*	600			RWU50-7	500	*No muntin [2x300 doors]			
RB450/175 500		RB590	900	RWU80-5#	800			RWU60-7	600	#2x Doors			
RB460/175 600		RB510	1000	RWU90-5#	900					Add 'X' to the end of the code for 350mm deep			
4x175mm Drawers		5x140mm Drawers		RWU10-5#	1000								
				*No muntin [2 x 300 doors]									
				#2 x Doors									
				Add 'X' to the end of the code for 350mm deep									

MEDIUM WALL      TALL WALL

H:720mm CODE	WIDTH	H:720mm CODE	WIDTH	H:720mm CODE	WIDTH	H:720mm CODE	WIDTH	H:720mm CODE	WIDTH	H:900mm CODE	WIDTH		
RWU260-7	600	RAWU360-7	360	RCDWU30-7	300x300	RMWU60-7	600	RBFWU50-7	500	RWU30-9	300	R2WU60-9*	600
Inc. 60x60mm Corner Post		Add 'X' to the end of the code for 350mm deep				283mm flap, 110mm filler; Mechanism inc.		RBFWU60-7	600	RWU40-9	400	RWU80-9#	800
Add 'X' to the end of the code for 350mm deep						Add 'X' to the end of the code for 350mm deep		RBFWU80-7	800	RWU45-9	450	RWU90-9#	900
								RBFWU90-7	900	RWU50-9	500	RWU10-9#	1000
								RBFWU10-7	1000	RMWU60-9	600	*No muntin [2x300 doors]	
										#2 x Doors			
										Add 'X' to the end of the code for 350mm deep			

Note: Furniture codes beginning with the letter 'R' are assembled (rigid), by removing the 'R' the units are supplied unassembled (flat-pack).

TALL WALL HORIZONTAL WALL OPEN WALL

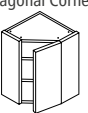
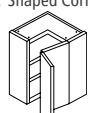
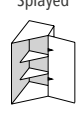
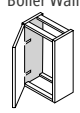
<p><b>Diagonal Corner</b></p>  <p>H:900mm CODE <b>RCWD60-9</b> WIDTH 600x600 Add 'X' to the end of the code for 350mm deep [650x650]</p>	<p><b>'L' Shaped Corner</b></p>  <p>H:900mm CODE <b>RCWL60-9</b> WIDTH 600x600 Add 'X' to the end of the code for 350mm deep [650x650]</p>	<p><b>Splayed</b></p>  <p>H:900mm CODE <b>RAWU360-9</b> WIDTH 360 Add 'X' to the end of the code for 350mm deep</p>	<p><b>Boiler Wall</b></p>  <p>H:900mm CODE <b>BWU6040-9</b> WIDTH 600 400mm Deep Flatpack</p>	<p><b>H:290mm</b></p> <table border="0"> <tr><td>CODE</td><td>WIDTH</td></tr> <tr><td><b>RHWU5029</b></td><td>500</td></tr> <tr><td><b>RHWU6029</b></td><td>600</td></tr> <tr><td><b>RHWU8029</b></td><td>800</td></tr> <tr><td><b>RHWU9029</b></td><td>900</td></tr> <tr><td><b>RHWU1029</b></td><td>1000</td></tr> </table>	CODE	WIDTH	<b>RHWU5029</b>	500	<b>RHWU6029</b>	600	<b>RHWU8029</b>	800	<b>RHWU9029</b>	900	<b>RHWU1029</b>	1000	<p><b>H:360mm</b></p> <table border="0"> <tr><td>CODE</td><td>WIDTH</td></tr> <tr><td><b>RHWU5036</b></td><td>500</td></tr> <tr><td><b>RHWU6036</b></td><td>600</td></tr> <tr><td><b>RHWU8036</b></td><td>800</td></tr> <tr><td><b>RHWU9036</b></td><td>900</td></tr> <tr><td><b>RHWU1036</b></td><td>1000</td></tr> </table>	CODE	WIDTH	<b>RHWU5036</b>	500	<b>RHWU6036</b>	600	<b>RHWU8036</b>	800	<b>RHWU9036</b>	900	<b>RHWU1036</b>	1000	<p><b>H:290mm</b></p> <table border="0"> <tr><td>CODE</td><td>WIDTH</td></tr> <tr><td><b>RWOS50-2</b></td><td>500</td></tr> <tr><td><b>RWOS60-2</b></td><td>600</td></tr> <tr><td><b>RWOS80-2</b></td><td>800</td></tr> <tr><td><b>RWOS90-2</b></td><td>900</td></tr> <tr><td><b>RWOS10-2</b></td><td>1000</td></tr> </table> <p>MFC Carcase</p>	CODE	WIDTH	<b>RWOS50-2</b>	500	<b>RWOS60-2</b>	600	<b>RWOS80-2</b>	800	<b>RWOS90-2</b>	900	<b>RWOS10-2</b>	1000	<p><b>H:360mm</b></p> <table border="0"> <tr><td>CODE</td><td>WIDTH</td></tr> <tr><td><b>RWOS50-3</b></td><td>500</td></tr> <tr><td><b>RWOS60-3</b></td><td>600</td></tr> <tr><td><b>RWOS80-3</b></td><td>800</td></tr> <tr><td><b>RWOS90-3</b></td><td>900</td></tr> <tr><td><b>RWOS10-3</b></td><td>1000</td></tr> </table> <p>MFC Carcase</p>	CODE	WIDTH	<b>RWOS50-3</b>	500	<b>RWOS60-3</b>	600	<b>RWOS80-3</b>	800	<b>RWOS90-3</b>	900	<b>RWOS10-3</b>	1000
CODE	WIDTH																																																						
<b>RHWU5029</b>	500																																																						
<b>RHWU6029</b>	600																																																						
<b>RHWU8029</b>	800																																																						
<b>RHWU9029</b>	900																																																						
<b>RHWU1029</b>	1000																																																						
CODE	WIDTH																																																						
<b>RHWU5036</b>	500																																																						
<b>RHWU6036</b>	600																																																						
<b>RHWU8036</b>	800																																																						
<b>RHWU9036</b>	900																																																						
<b>RHWU1036</b>	1000																																																						
CODE	WIDTH																																																						
<b>RWOS50-2</b>	500																																																						
<b>RWOS60-2</b>	600																																																						
<b>RWOS80-2</b>	800																																																						
<b>RWOS90-2</b>	900																																																						
<b>RWOS10-2</b>	1000																																																						
CODE	WIDTH																																																						
<b>RWOS50-3</b>	500																																																						
<b>RWOS60-3</b>	600																																																						
<b>RWOS80-3</b>	800																																																						
<b>RWOS90-3</b>	900																																																						
<b>RWOS10-3</b>	1000																																																						

Add 'X' to the end of the code for 350mm deep

If 350mm deep carcase is required adjust code, e.g RWOS1035-2

If 350mm deep carcase is required adjust code, e.g RWOS1035-3

OPEN WALL MIDI UNITS LARDER

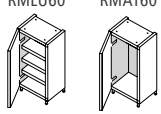
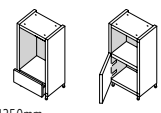
<p><b>H:575mm</b></p> <table border="0"> <tr><td>CODE</td><td>WIDTH</td></tr> <tr><td><b>RWOS30-5</b></td><td>300</td></tr> <tr><td><b>RWOS40-5</b></td><td>400</td></tr> <tr><td><b>RWOS45-5</b></td><td>450</td></tr> <tr><td><b>RWOS50-5</b></td><td>500</td></tr> <tr><td><b>RWOS60-5</b></td><td>600</td></tr> <tr><td><b>RWOS80-5</b></td><td>800</td></tr> <tr><td><b>RWOS90-5</b></td><td>900</td></tr> <tr><td><b>RWOS10-5</b></td><td>1000</td></tr> </table> <p>MFC Carcase</p>	CODE	WIDTH	<b>RWOS30-5</b>	300	<b>RWOS40-5</b>	400	<b>RWOS45-5</b>	450	<b>RWOS50-5</b>	500	<b>RWOS60-5</b>	600	<b>RWOS80-5</b>	800	<b>RWOS90-5</b>	900	<b>RWOS10-5</b>	1000	<p><b>H:720mm</b></p> <table border="0"> <tr><td>CODE</td><td>WIDTH</td></tr> <tr><td><b>RWOS30-7</b></td><td>300</td></tr> <tr><td><b>RWOS40-7</b></td><td>400</td></tr> <tr><td><b>RWOS45-7</b></td><td>450</td></tr> <tr><td><b>RWOS50-7</b></td><td>500</td></tr> <tr><td><b>RWOS60-7</b></td><td>600</td></tr> <tr><td><b>RWOS80-7</b></td><td>800</td></tr> <tr><td><b>RWOS90-7</b></td><td>900</td></tr> <tr><td><b>RWOS10-7</b></td><td>1000</td></tr> </table> <p>MFC Carcase</p>	CODE	WIDTH	<b>RWOS30-7</b>	300	<b>RWOS40-7</b>	400	<b>RWOS45-7</b>	450	<b>RWOS50-7</b>	500	<b>RWOS60-7</b>	600	<b>RWOS80-7</b>	800	<b>RWOS90-7</b>	900	<b>RWOS10-7</b>	1000	<p><b>H:900mm</b></p> <table border="0"> <tr><td>CODE</td><td>WIDTH</td></tr> <tr><td><b>RWOS30-9</b></td><td>300</td></tr> <tr><td><b>RWOS40-9</b></td><td>400</td></tr> <tr><td><b>RWOS45-9</b></td><td>450</td></tr> <tr><td><b>RWOS50-9</b></td><td>500</td></tr> <tr><td><b>RWOS60-9</b></td><td>600</td></tr> <tr><td><b>RWOS80-9</b></td><td>800</td></tr> <tr><td><b>RWOS90-9</b></td><td>900</td></tr> <tr><td><b>RWOS10-9</b></td><td>1000</td></tr> </table> <p>MFC Carcase</p>	CODE	WIDTH	<b>RWOS30-9</b>	300	<b>RWOS40-9</b>	400	<b>RWOS45-9</b>	450	<b>RWOS50-9</b>	500	<b>RWOS60-9</b>	600	<b>RWOS80-9</b>	800	<b>RWOS90-9</b>	900	<b>RWOS10-9</b>	1000	<p><b>H:1210mm</b></p> <table border="0"> <tr><td>CODE</td><td>WIDTH</td></tr> <tr><td><b>RDC1/50</b></td><td>500</td></tr> <tr><td><b>RDC1/60</b></td><td>600</td></tr> </table> <p>MFC Carcase</p> <p style="font-size: 8px;">If 350mm deep carcase is required adjust code, e.g RDC1/3550</p>	CODE	WIDTH	<b>RDC1/50</b>	500	<b>RDC1/60</b>	600	<p><b>RMLU60</b> <b>RMA160</b></p>  <p><b>RMD060</b> <b>RMOHS60</b></p>  <p><b>H:1250mm</b></p> <table border="0"> <tr><td>CODE</td><td>WIDTH</td></tr> <tr><td><b>RMLU60</b></td><td>600</td></tr> <tr><td><b>RMA160</b></td><td>600</td></tr> <tr><td><b>RMD060</b></td><td>600</td></tr> <tr><td><b>RMOHS60</b></td><td>600</td></tr> </table>	CODE	WIDTH	<b>RMLU60</b>	600	<b>RMA160</b>	600	<b>RMD060</b>	600	<b>RMOHS60</b>	600	<p><b>LARDER</b></p> <table border="0"> <tr> <td> <p><b>H:1970mm</b></p> <table border="0"> <tr><td>CODE</td><td>WIDTH</td></tr> <tr><td><b>RTLU30</b></td><td>300</td></tr> <tr><td><b>RTLU40</b></td><td>400</td></tr> <tr><td><b>RTLU50</b></td><td>500</td></tr> <tr><td><b>RTLU60</b></td><td>600</td></tr> <tr><td><b>TLU80</b></td><td>800</td></tr> <tr><td><b>TLU10</b></td><td>1000</td></tr> </table> </td> <td> <p><b>H:2150mm</b></p> <table border="0"> <tr><td>CODE</td><td>WIDTH</td></tr> <tr><td><b>RETLU30</b></td><td>300</td></tr> <tr><td><b>RETLU40</b></td><td>400</td></tr> <tr><td><b>RETLU50</b></td><td>500</td></tr> <tr><td><b>RETLU60</b></td><td>600</td></tr> <tr><td><b>ETLU80</b></td><td>800</td></tr> <tr><td><b>ETLU10</b></td><td>1000</td></tr> </table> </td> </tr> </table>	<p><b>H:1970mm</b></p> <table border="0"> <tr><td>CODE</td><td>WIDTH</td></tr> <tr><td><b>RTLU30</b></td><td>300</td></tr> <tr><td><b>RTLU40</b></td><td>400</td></tr> <tr><td><b>RTLU50</b></td><td>500</td></tr> <tr><td><b>RTLU60</b></td><td>600</td></tr> <tr><td><b>TLU80</b></td><td>800</td></tr> <tr><td><b>TLU10</b></td><td>1000</td></tr> </table>	CODE	WIDTH	<b>RTLU30</b>	300	<b>RTLU40</b>	400	<b>RTLU50</b>	500	<b>RTLU60</b>	600	<b>TLU80</b>	800	<b>TLU10</b>	1000	<p><b>H:2150mm</b></p> <table border="0"> <tr><td>CODE</td><td>WIDTH</td></tr> <tr><td><b>RETLU30</b></td><td>300</td></tr> <tr><td><b>RETLU40</b></td><td>400</td></tr> <tr><td><b>RETLU50</b></td><td>500</td></tr> <tr><td><b>RETLU60</b></td><td>600</td></tr> <tr><td><b>ETLU80</b></td><td>800</td></tr> <tr><td><b>ETLU10</b></td><td>1000</td></tr> </table>	CODE	WIDTH	<b>RETLU30</b>	300	<b>RETLU40</b>	400	<b>RETLU50</b>	500	<b>RETLU60</b>	600	<b>ETLU80</b>	800	<b>ETLU10</b>	1000
CODE	WIDTH																																																																																																								
<b>RWOS30-5</b>	300																																																																																																								
<b>RWOS40-5</b>	400																																																																																																								
<b>RWOS45-5</b>	450																																																																																																								
<b>RWOS50-5</b>	500																																																																																																								
<b>RWOS60-5</b>	600																																																																																																								
<b>RWOS80-5</b>	800																																																																																																								
<b>RWOS90-5</b>	900																																																																																																								
<b>RWOS10-5</b>	1000																																																																																																								
CODE	WIDTH																																																																																																								
<b>RWOS30-7</b>	300																																																																																																								
<b>RWOS40-7</b>	400																																																																																																								
<b>RWOS45-7</b>	450																																																																																																								
<b>RWOS50-7</b>	500																																																																																																								
<b>RWOS60-7</b>	600																																																																																																								
<b>RWOS80-7</b>	800																																																																																																								
<b>RWOS90-7</b>	900																																																																																																								
<b>RWOS10-7</b>	1000																																																																																																								
CODE	WIDTH																																																																																																								
<b>RWOS30-9</b>	300																																																																																																								
<b>RWOS40-9</b>	400																																																																																																								
<b>RWOS45-9</b>	450																																																																																																								
<b>RWOS50-9</b>	500																																																																																																								
<b>RWOS60-9</b>	600																																																																																																								
<b>RWOS80-9</b>	800																																																																																																								
<b>RWOS90-9</b>	900																																																																																																								
<b>RWOS10-9</b>	1000																																																																																																								
CODE	WIDTH																																																																																																								
<b>RDC1/50</b>	500																																																																																																								
<b>RDC1/60</b>	600																																																																																																								
CODE	WIDTH																																																																																																								
<b>RMLU60</b>	600																																																																																																								
<b>RMA160</b>	600																																																																																																								
<b>RMD060</b>	600																																																																																																								
<b>RMOHS60</b>	600																																																																																																								
<p><b>H:1970mm</b></p> <table border="0"> <tr><td>CODE</td><td>WIDTH</td></tr> <tr><td><b>RTLU30</b></td><td>300</td></tr> <tr><td><b>RTLU40</b></td><td>400</td></tr> <tr><td><b>RTLU50</b></td><td>500</td></tr> <tr><td><b>RTLU60</b></td><td>600</td></tr> <tr><td><b>TLU80</b></td><td>800</td></tr> <tr><td><b>TLU10</b></td><td>1000</td></tr> </table>	CODE	WIDTH	<b>RTLU30</b>	300	<b>RTLU40</b>	400	<b>RTLU50</b>	500	<b>RTLU60</b>	600	<b>TLU80</b>	800	<b>TLU10</b>	1000	<p><b>H:2150mm</b></p> <table border="0"> <tr><td>CODE</td><td>WIDTH</td></tr> <tr><td><b>RETLU30</b></td><td>300</td></tr> <tr><td><b>RETLU40</b></td><td>400</td></tr> <tr><td><b>RETLU50</b></td><td>500</td></tr> <tr><td><b>RETLU60</b></td><td>600</td></tr> <tr><td><b>ETLU80</b></td><td>800</td></tr> <tr><td><b>ETLU10</b></td><td>1000</td></tr> </table>	CODE	WIDTH	<b>RETLU30</b>	300	<b>RETLU40</b>	400	<b>RETLU50</b>	500	<b>RETLU60</b>	600	<b>ETLU80</b>	800	<b>ETLU10</b>	1000																																																																												
CODE	WIDTH																																																																																																								
<b>RTLU30</b>	300																																																																																																								
<b>RTLU40</b>	400																																																																																																								
<b>RTLU50</b>	500																																																																																																								
<b>RTLU60</b>	600																																																																																																								
<b>TLU80</b>	800																																																																																																								
<b>TLU10</b>	1000																																																																																																								
CODE	WIDTH																																																																																																								
<b>RETLU30</b>	300																																																																																																								
<b>RETLU40</b>	400																																																																																																								
<b>RETLU50</b>	500																																																																																																								
<b>RETLU60</b>	600																																																																																																								
<b>ETLU80</b>	800																																																																																																								
<b>ETLU10</b>	1000																																																																																																								

If 350mm deep carcase is required adjust code, e.g RWOS1035-5

If 350mm deep carcase is required adjust code, e.g RWOS1035-7

If 350mm deep carcase is required adjust code, e.g RWOS1035-9

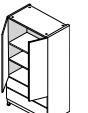
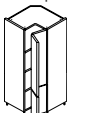
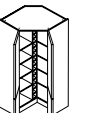
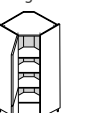
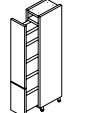
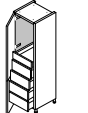
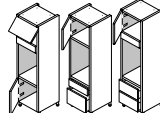
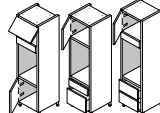

LARDER PULL-OUT LARDER INNER DRAWER LARDER DOUBLE OVEN

<p><b>Drawer Larder</b></p>  <p>H:1970mm CODE <b>TDLU80</b> WIDTH 800 <b>TDLU10</b> 1000 2x355 drawers</p>	<p><b>'L' Shaped</b></p>  <p>H:1970mm *H:2150mm CODE <b>TCLU98</b> WIDTH 985x985 <b>ETCLU98*</b> 985x985 Bi-fold hinge system</p>	<p><b>Diagonal Walk-in Larder</b></p>  <p>H:1970mm *H:2150mm CODE <b>TDWIL1144</b> WIDTH 1144x1144 <b>ETDWIL1144*</b> 1144x1144</p>	<p><b>Diagonal</b></p>  <p>H:1970mm *H:2150mm CODE <b>TDCLU1003</b> WIDTH 1003x1003 <b>ETDCLU1003*</b> 1003x1003</p>	<p><b>PULL-OUT LARDER</b></p>  <p>H:1970mm *H:2150mm CODE <b>RTISPOL30</b> WIDTH 300 <b>RTKPOL30</b> 300 Standard Mechanism inc. <b>RETSPOL30*</b> 300 <b>RETKPOL30*</b> 300 Kesseböhmer Mechanism inc.</p>	<p><b>INNER DRAWER LARDER</b></p>  <p>H:1970mm *H:2150mm CODE <b>RTLID30</b> WIDTH 300 <b>RTLID40</b> 400 <b>RTLID50</b> 500 <b>RTLID60</b> 600 1 x Standard, 4 x Deep Drawers</p>	<p><b>DOUBLE OVEN</b></p>  <p>H:1970mm *H:2150mm CODE <b>RETLID30</b> WIDTH 300 <b>RETLID40</b> 400 <b>RETLID50</b> 500 <b>RETLID60</b> 600 1 x Standard, 4 x Deep drawers</p>	<p><b>DOUBLE OVEN</b></p>  <p>H:1970mm *H:2150mm CODE <b>RTOHD60</b> WIDTH 600 <b>RTOHD60</b> 600 <b>RETOHDD60*</b> 600</p>
--	---	---	--	---	--	--	---

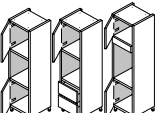
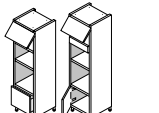
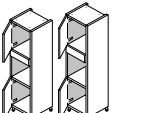
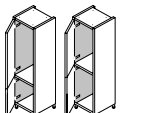
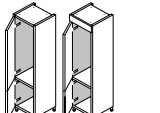
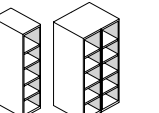
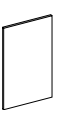

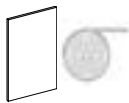
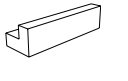
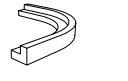

SINGLE OVEN SINGLE OVEN + COMPACT COMPACT TALL FRIDGE/FREEZER BOX WINE RACKS END SUPPORT PANELS

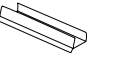
<p><b>SINGLE OVEN</b></p>  <p>H:1970mm *H:2150mm CODE <b>RTOHS60</b> WIDTH 600 <b>RTOHS60</b> 600 <b>RETOHS60*</b> 600</p>	<p><b>SINGLE OVEN + COMPACT</b></p>  <p>H:1970mm *H:2150mm CODE <b>RTOHC60</b> WIDTH 600 <b>RETOHC60*</b> 600</p>	<p><b>COMPACT</b></p>  <p>H:1970mm *H:2150mm CODE <b>RTOHC60</b> WIDTH 600 <b>RETOHC60*</b> 600</p>	<p><b>TALL FRIDGE/FREEZER</b></p>  <p>H:1970mm CODE <b>RTFF1/60</b> WIDTH 600 <b>RTFF4/60*</b> 600 *Doors undrilled <b>RTFF1U/60#</b> 600 <b>RTFF4U/60#</b> 600 #For door on door appliances</p>	<p><b>TALL FRIDGE/FREEZER</b></p>  <p>H:2150mm CODE <b>RETF1/60</b> WIDTH 600 <b>RETF2/60</b> 600 <b>RETF1U/60#</b> 600 <b>RETF2U/60#</b> 600 *For door on door appliances</p>	<p><b>BOX WINE RACKS</b></p>  <p>W:125mm / W:250mm* CODE <b>RWR125-7</b> HEIGHT 720 <b>RWR250-7*</b> 720 <b>RWR125-9</b> 900 <b>RWR250-9*</b> 900 <b>RWR125-1210</b> 1210 <b>WR125-1970</b> 1970 <b>WR250-1970*</b> 1970 MFC Carcase If using as base order LEGSET</p>	<p><b>END SUPPORT PANELS</b></p>  <p>H:900mm CODE <b>ESP</b> WIDTH 600 <b>900/700</b> 700 MFC Carcase</p>
--	--	--	---	--	---	--

CARCASE MFC PANELS CORNICE / PELMET PLINTH

<p><b>CARCASE MFC PANELS</b></p>  <p>CODE <b>1970/300</b> WXH 300x1970 <b>2150/560</b> 560x2150 <b>2350/660</b> 660x2350 <b>720/300</b> 300x720 <b>900/2000</b> 2000x900 <b>900/300</b> 300x900 MFC Carcase</p>	<p><b>CORNICE / PELMET</b></p>  <p>H:28mm CODE <b>CM/ML</b> LENGTH 3000 Door Finish</p>	<p><b>Curved Combi Section</b></p>  <p>H:28mm CODE <b>CCMS/ML</b> WIDTH 318x318 Door Finish Use in conjunction with CM/ML</p>	<p><b>PLINTH</b></p>  <p>H:150mm CODE <b>PL</b> WIDTH 2940 MFC Carcase <b>PL/ML</b> 3000 Door Finish</p>	<p><b>Curved Plinth Section</b></p>  <p>H:150mm CODE <b>CPLS/ML</b> WIDTH 300x407 Door Finish Use in conjunction with PL/ML</p>	<p><b>Clear Sealing Strip</b></p>  <p>CODE <b>PST</b> WIDTH 3000</p>
--	--	--	--	--	---

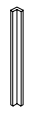
PLANT ON END PANELS FURNITURE ACCESSORIES INTEGRATED DOORS SPARE DOOR FITTINGS GENERAL ACCS.

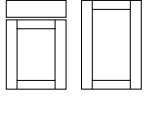
<p><b>18mm</b></p>  <p>CODE <b>2400/650/18ML</b> WXH 650x2400 <b>780/375/18ML</b> 375x780 <b>900/650/18ML</b> 650x900 <b>960/375/18ML</b> 375x960 Door Finish</p>	<p><b>18mm Breakfast Bar Panel</b></p>  <p>CODE <b>900/2400/18ML</b> WXH 2400x900 Door Finish</p>	<p><b>Corner Post (Spare)</b></p>  <p>H:715mm CODE <b>CP/ML</b> WIDTH 146 Flat panel for on site conversion Door Finish</p>	<p><b>Tall Feature Post</b></p>  <p>H:2400mm CODE <b>TFP/ML</b> WXD 40x100</p>	<p><b>Undrilled</b></p>  <p>CODE <b>INT4571</b> WXH 446x715 <b>INT6071</b> 596x715</p>	<p><b>SPARE DOOR FITTINGS</b></p> <p>Hinges [Hettich Soft Close]</p> <p>CODE <b>SCHINGE90</b> 90 degree [Pair] <b>SCHINGE170</b> 170 degree [Pair]</p> <p>Stays [Blum Aventos]</p> <p>CODE <b>BLSTAYHKS</b> HK-5 stay [Pair] *[inc mounting brackets]</p>	<p><b>GENERAL ACCS.</b></p> <p>CODE <b>STPNW</b> Set of 2 Door Strapping Plates <b>LEGSET</b> Set of 4 Adjustable legs <b>SACC</b> Pk 50 14mm Self Adhesive Cover Caps</p>
--	--	--	---	--	---	--

Note: Furniture codes beginning with the letter 'R' are assembled (rigid), by removing the 'R' the units are supplied unassembled (flat-pack).



SLAB

PRICE GROUP 2

**VIRA**

Special sizes available  
contact us for further information

Colours Options [PG2]: Anthracite, Black, Blush, Fern, Fjord, Grey, Hunter, Indigo, Mussel, Navy, Porcelain and Terracotta.



**HI-LINE BASE** **Pull-Out** **Curved Door** **Shallow Base [300mm deep]** **LOW BASE** **HI-LINE CORNER BASE**

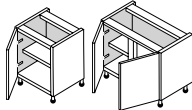

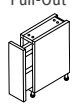
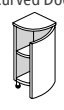

H:720mm CODE	WIDTH	CODE	WIDTH
RBA15	150	R2BA60*	600
RBA26	260	RBA70#	700
RBA30	300	RBA80#	800
RBA35	350	RBA90#	900
RBA40	400	RBA10#	1000
RBA45	450	RBA12#	1200
RBA50	500	*No muntin [2x300 doors]	
RBA60	600	# 2 x Doors	



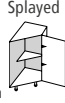

H:720mm CODE	WIDTH	H:720mm CODE	WIDTH
RBISPO15	150	RCDBA30	300x300

Standard Mechanism inc.  
RBKPO15 150  
Kesseböhmer Mechanism inc.  
RBKTPO15 150  
Kesseböhmer Mechanism & Towel rail inc.

H:720mm CODE	WIDTH	H:720mm CODE	WIDTH
RABA360	360	RCRBA26	260

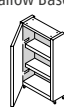

H:720mm CODE	WIDTH	CODE	WIDTH
RSBU30	300	RSBU70#	700
RSBU35	350	RSBU80#	800
RSBU40	400	RSBU90#	900
RSBU45	450	RSBU10#	1000
RSBU50	500	# 2 x Doors	
RSBU60	600		

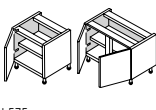

H:575mm CODE	WIDTH	CODE	WIDTH
RLBU30	300	RLBU40	400
RLBU45	450	RLBU50	500
RLBU60	600	RLBU80#	800
RLBU90#	900	RLBU10#	1000
RLBU12#	1200		



# 2 x Doors



H:720mm CODE	WIDTH	CODE	WIDTH
RBAC830	800/300	RBAC950	900/500
RBAC80	800/400	RBAC960	900/600
RBAC845	800/450	RBAC140	1000/400
RBAC850	800/500	RBAC145	1000/450
RBAC860	800/600	RBAC10	1000/500
RBAC940	900/400	RBAC160	1000/600
RBAC945	900/450	RBAC12	1200/600



Inc. Corner Post & Blanking Panel

**HI-LINE CORNER BASE** **DRAWERLINE BASE** **DRAWERLINE SINK BASE** **CERAMIC SINK BASE** **DRAWERLINE CORNER BASE**



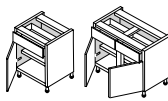

H:720mm CODE	WIDTH	H:720mm CODE	WIDTH
BAC90	900x900	CDA90	900x900

Bi-fold hinge system  
Flatpack



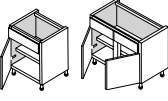

H:720mm CODE	WIDTH	CODE	WIDTH
RBD30	300	RBD80#	800
RBD40	400	RBD90#	900
RBD45	450	RBD10#	1000
RBD50	500	RBD12#	1200
RBD60	600	# 2 x Doors	

H:720mm CODE	WIDTH	H:720mm CODE	WIDTH
RBD80/1	800	RBD50	500
RBD90/1	900	RBD60	600
RBD10/1	1000	RBD80#	800
		RBD90#	900
		RBD10*#	1000
		RBD12*#	1200

To suit a sink height of 260mm  
\*One working drawer  
# 2 x Doors

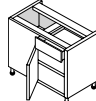

H:720mm CODE	WIDTH	CODE	WIDTH
RBDC830	800/300	RBDC140	1000/400
RBDC80	800/400	RBDC145	1000/450
RBDC845	800/450	RBDC10	1000/500
RBDC850	800/500	RBDC160	1000/600
RBDC860	800/600	RBDC12	1200/600

Inc. Corner Post & Blanking Panel

**BUILT UNDER** **2 DRAWER BASE** **3 DRAWER BASE** **4 DRAWER BASE** **5 DRAWER BASE** **LOW WALL**

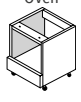
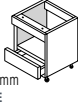



H:720mm CODE	WIDTH	H:720mm CODE	WIDTH
RBW060	600	RBD250	500
		RBD260	600
		RBD280	800
		RBD290	900
		RBD210	1000

2x355mm Drawers

H:720mm CODE	WIDTH
RBUM60	600

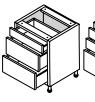
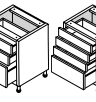
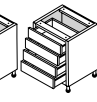
175mm drawer & 110mm filler







H:720mm CODE	WIDTH	H:720mm CODE	WIDTH
RBD350	500	RBD450	500
RBD360	600	RBD460	600
RBD380	800	RBD480	800
RBD390	900	RBD490	900
RBD310	1000	RBD410	1000

1x140mm, 2x283mm Drawers  
3x140mm, 1x283mm Drawers  
2x175mm, 1x355mm Drawers  
4x175mm Drawers

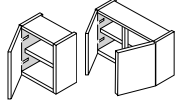
H:720mm CODE	WIDTH	H:720mm CODE	WIDTH
RBD350/175	500	RBD450/175	500
RBD360/175	600	RBD460/175	600

5x140mm Drawers



H:575mm CODE	WIDTH	CODE	WIDTH
RWU30-5	300	R2WU60-5*#	600
RWU40-5	400	RWU80-5#	800
RWU45-5	450	RWU90-5#	900
RWU50-5	500	RWU10-5#	1000
RWU60-5	600	*No muntin # 2 x Doors	

Add 'X' to the end of the code for 350mm deep

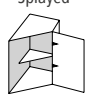
H:575mm CODE	WIDTH	H:575mm CODE	WIDTH
RCWD60-5	600x600	RAWU360-5	360

Add 'X' to the end of the code for 350mm deep [650x650]  
Add 'X' to the end of the code for 350mm deep

**MEDIUM WALL** **Glazed Door** **Diagonal Corner** **'L' Shaped Corner** **Conventional Corner** **Splayed** **Curved Door** **Microwave Wall**

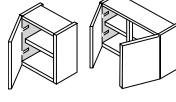

H:720mm CODE	WIDTH	CODE	WIDTH
RWU26-7	260	R2WU60-7*	600
RWU30-7	300	RWU70-7#	700
RWU35-7	350	RWU80-7#	800
RWU40-7	400	RWU90-7#	900
RWU45-7	450	RWU10-7#	1000
RWU50-7	500	*No muntin [2x300 doors]	
RWU60-7	600	# 2 x Doors	

Add 'X' to the end of the code for 350mm deep

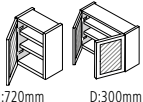
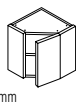

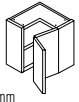

H:720mm CODE	D:300mm	H:720mm CODE	WIDTH
RWG50-7*	500	RCWD60-7	600x600
RWG10-7*	1000	Add 'X' to the end of the code for 350mm deep [650x650]	

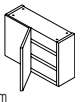

H:720mm CODE	WIDTH
RCWL60-7	600x600

Bi-fold hinge system  
Add 'X' to the end of the code for 350mm deep [650x650]



H:720mm CODE	WIDTH
RWUC60-7	600

Inc. Corner Post  
Add 'X' to the end of the code for 350mm deep

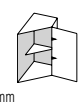

H:720mm CODE	WIDTH
RAWU360-7	360

Add 'X' to the end of the code for 350mm deep

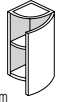
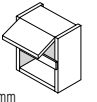
H:720mm CODE	WIDTH	H:720mm CODE	WIDTH
RCDWU30	300x300	RMWU60-7	600

283mm flap, 110mm filler; Mechanism inc.  
Add 'X' to the end of the code for 350mm deep

**MEDIUM WALL** **TALL WALL** **Glazed Door** **Diagonal Corner** **Splayed** **Boiler Wall** **HORIZONTAL WALL**

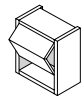

H:720mm CODE	WIDTH	H:900mm CODE	WIDTH
RBFWU50-7	500	RWU30-9	300
RBFWU60-7	600	RWU40-9	400
RBFWU80-7	800	RWU45-9	450
RBFWU90-7	900	RWU50-9	500
RBFWU10-7	1000	RWU60-9	600

Mechanism inc.  
Add 'X' to the end of the code for 350mm deep

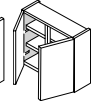
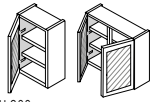
H:900mm CODE	WIDTH	H:900mm CODE	WIDTH
R2WU60-9*	600	RWG50-9*	500
RWU80-9#	800	RWG10-9*	1000
RWU90-9#	900	Add 'X' to the end of the code for 350mm deep	
RWU10-9#	1000	*No muntin [2x300 doors]	

# 2 x Doors



H:900mm CODE	WIDTH
RCWD60-9	600x600

Add 'X' to the end of the code for 350mm deep [650x650]

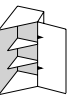

H:900mm CODE	WIDTH
RAWU360-9	360

Add 'X' to the end of the code for 350mm deep

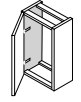

H:900mm CODE	WIDTH
BWU6040-9	600

400mm Deep  
Flatpack

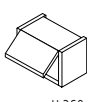

H:290mm CODE	WIDTH	H:360mm CODE	WIDTH
RHWU5029	500	RHWU5036	500
RHWU6029	600	RHWU6036	600
RHWU8029	800	RHWU8036	800
RHWU9029	900	RHWU9036	900
RHWU1029	1000	RHWU1036	1000

Add 'X' to the end of the code for 350mm deep





SLAB  
PRICE GROUP 3  
**ZETA**  
GLOSS + MATT

Special sizes available  
contact us for further information

Gloss Colours Options [PG3]: Cashmere, Grey and White  
Matt Colours Options [PG3]: Aegean, Blue Marble, Cashmere,  
Dust Grey, Graphite, Grey, Rose Marble and White.



HI-LINE BASE LOW BASE

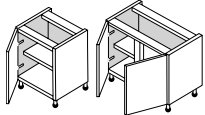

H:720mm CODE	WIDTH	600mm* CODE	WIDTH
RBA15	150	R2BA60*#	600
RBA26	260	RBA70#	700
RBA30	300	RBA80#	800
RBA35	350	RBA90#	900
RBA40	400	RBA10#	1000
RBA45	450	RBA12	1200
RBA50	500	*No muntin [2 x 300 doors] # 2 x Doors	

Pull-Out

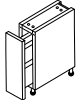

H:720mm CODE	WIDTH
RBISPO15	150

Standard Mechanism inc.  
Kesseböhmer Mechanism inc.  
RBKPO15 150  
Kesseböhmer Mechanism & Towel rail inc.  
RBKTP015 150

Splayed

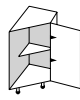

H:720mm CODE	WIDTH
RABA360	360

Shallow Base [300mm deep]

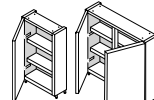

H:720mm CODE	WIDTH	H:720mm CODE	WIDTH
RSBU30	300	RSBU70#	700
RSBU35	350	RSBU80#	800
RSBU40	400	RSBU90#	900
RSBU45	450	RSBU10#	1000
RSBU50	500	# 2 x Doors	
RSBU60	600		

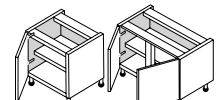

H:575mm CODE	WIDTH	H:575mm CODE	WIDTH
RLBU30	300	RLBU80#	800
RLBU40	400	RLBU90#	900
RLBU45	450	RLBU10#	1000
RLBU50	500	RLBU12#	1200
RLBU60	600	# 2 x Doors	

HI-LINE CORNER BASE HI-LINE CORNER BASE DRAWERLINE BASE DRAWERLINE SINK BASE CERAMIC SINK BASE DRAWERLINE CORNER



H:720mm CODE	WIDTH	CODE	WIDTH
RBAC830	800/300	RBAC950	900/500
RBAC80	800/400	RBAC960	900/600
RBAC845	800/450	RBAC140	1000/400
RBAC850	800/500	RBAC145	1000/450
RBAC860	800/600	RBAC10	1000/500
RBAC940	900/400	RBAC160	1000/600
RBAC945	900/450	RBAC12	1200/600

Inc. Corner Post & Blanking Panel

'L' Shaped

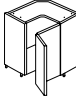

H:720mm CODE	WIDTH
BAC90	900x900

Bi-fold hinge system  
Flat pack

Diagonal



H:720mm CODE	WIDTH
CDA90	900x900

Flat pack

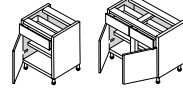

H:720mm CODE	WIDTH
RBD30	300
RBD40	400
RBD45	450
RBD50	500
RBD60	600
RBD80#	800
RBD90#	900
RBD10#	1000
RBD12#	1200

# 2 x Doors

Single Top Drawer



H:720mm CODE	WIDTH
RBD80/1	800
RBD90/1	900
RBD10/1	1000

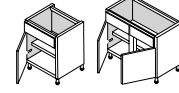

H:720mm CODE	WIDTH
RBDF50	500
RBDF60	600
RBDF80#	800
RBDF90#	900
RBDF10#	1000
RBDD10*#	1000
RBDD12*#	1200

\*One working drawer  
# 2 x Doors



CODE	WXH
RBSU60	600x460

To suit a sink height of 260mm



H:720mm CODE	WIDTH
RBDC830	800/300
RBDC80	800/400
RBDC845	800/450
RBDC850	800/500
RBDC860	800/600
RBDC140	1000/400
RBDC145	1000/450
RBDC10	1000/500
RBDC160	1000/600
RBDC12	1200/600

Inc. Corner Post & Blanking Panel

BUILT UNDER 2 DRAWER BASE 3 DRAWER BASE 4 DRAWER BASE 5 DRAWER BASE LOW WALL Diagonal Corner Splayed

Oven

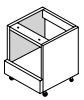

H:720mm CODE	WIDTH
RBUM60	600

175mm drawer & 110mm filler



H:720mm CODE	WIDTH
RBD250	500
RBD260	600
RBD280	800
RBD290	900
RBD210	1000

2x355mm Drawers

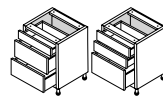

H:720mm CODE	WIDTH
RBD350	500
RBD360	600
RBD380	800
RBD390	900
RBD310	1000

1x140mm, 2x283mm Drawers

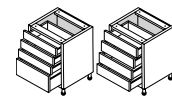

H:720mm CODE	WIDTH
RBD450	500
RBD460	600
RBD480	800
RBD490	900
RBD410	1000

3x140mm, 1x283mm Drawers

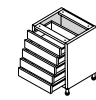

H:720mm CODE	WIDTH
RBD530	300
RBD540	400
RBD545	450
RBD550	500
RBD560	600
RBD580	800
RBD590	900
RBD510	1000

5x140mm Drawers

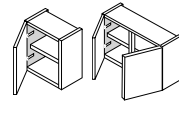

H:575mm CODE	D:300mm WIDTH
RWU30-5	300
RWU40-5	400
RWU45-5	450
RWU50-5	500
RWU60-5	600
R2WU60-5*#	600
RWU70-5#	700
RWU80-5#	800
RWU90-5#	900
RWU10-5#	1000

\*No muntin [2 x 300 doors]  
# 2 x Doors

Diagonal Corner

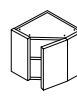

H:575mm CODE	D:300mm WIDTH
RCWD60-5	600x600

Add 'X' to the end of the code for 350mm deep [650x650]

Splayed

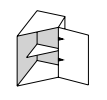

H:575mm CODE	D:300mm WIDTH
RAWU360-5	360

Add 'X' to the end of the code for 350mm deep

MEDIUM WALL Diagonal Corner 'L' Shaped Corner Conventional Corner Splayed Microwave Wall Bi-Fold

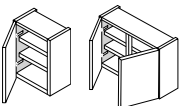

H:720mm CODE	WIDTH	D:300mm CODE	WIDTH
RWU26-7	260	R2WU60-7*#	600
RWU30-7	300	RWU70-7#	700
RWU35-7	350	RWU80-7#	800
RWU40-7	400	RWU90-7#	900
RWU45-7	450	RWU10-7#	1000
RWU50-7	500	*No muntin [2x300 doors] # 2 x Doors	
RWU60-7	600		

Add 'X' to the end of the code for 350mm deep

Diagonal Corner

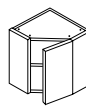

H:720mm CODE	D:300mm WIDTH
RCWD60-7	600x600

Add 'X' to the end of the code for 350mm deep [650x650]

'L' Shaped Corner

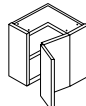

H:720mm CODE	D:300mm WIDTH
RCWL60-7	600x600

Bi-fold hinge system  
Add 'X' to the end of the code for 350mm deep [650x650]

Conventional Corner

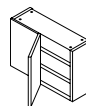

H:720mm CODE	D:300mm WIDTH
RWUC60-7	600

Inc. Corner Post  
Add 'X' to the end of the code for 350mm deep

Splayed

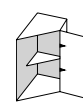

H:720mm CODE	D:300mm WIDTH
RAWU360-7	360

Add 'X' to the end of the code for 350mm deep

Microwave Wall

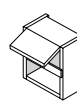

H:720mm CODE	D:300mm WIDTH
RMWU60-7	600

283mm flap, 110mm filler; Mechanism inc.  
Add 'X' to the end of the code for 350mm deep

Bi-Fold

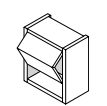

H:720mm CODE	D:300mm WIDTH
RBFWU50-7	500
RBFWU60-7	600
RBFWU80-7	800
RBFWU90-7	900
RBFWU10-7	1000

Mechanism inc.  
Add 'X' to the end of the code for 350mm deep









# Bedrooms.

It's time to wind down and get comfortable, relax into a peaceful slumber.

Our bedroom range ensures your private retreat is clutter free to set the perfect ambience. With our bedroom range, your private retreat is thoughtfully designed to maintain a clutter-free environment, ensuring the ideal ambience for your relaxation.

BEDROOMS  
PRICE GROUP 7  
**HOLTON**

Colours Options: Anthracite, Blueberry, Fjord, Laurel, Lichen, Oyster, Monsoon, Stone, Storm Grey and White.



**ROBE**

Standard Height

Tall Height

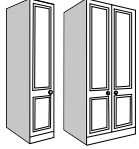

H:2116mm	WIDTH	H:2221mm	WIDTH
<b>SR30</b>	300	<b>TR30</b>	300
<b>SR35</b>	350	<b>TR35</b>	350
<b>SR40</b>	400	<b>TR40</b>	400
<b>SR45</b>	450	<b>TR45</b>	450
<b>SR50</b>	500	<b>TR50</b>	500
<b>SR60*</b>	600	<b>TR60*</b>	600
<b>SR70</b>	700	<b>TR70</b>	700
<b>SR80</b>	800	<b>TR80</b>	800
<b>SR90</b>	900	<b>TR90</b>	900
<b>SR10</b>	1000	<b>TR10</b>	1000

CODE

Solid Door  
\*2 x Doors

Standard Height

Tall Height

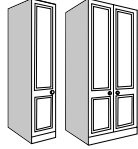

H:2116mm	WIDTH	H:2221mm	WIDTH
<b>SMR40</b>	400	<b>TMR40</b>	400
<b>SMR45</b>	450	<b>TMR45</b>	450
<b>SMR50</b>	500	<b>TMR50</b>	500
<b>SMR80</b>	800	<b>TMR80</b>	800
<b>SMR90</b>	900	<b>TMR90</b>	900
<b>SMR10</b>	1000	<b>TMR10</b>	1000

CODE

Mirror Door

**CORNER ROBE**

Standard Height

Tall Height

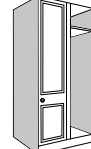

H:2116mm	WIDTH	H:2221mm	WIDTH
<b>SCR60</b>	600	<b>TCR60</b>	600
<b>SCR80</b>	800	<b>TCR80</b>	800
<b>SCR90</b>	900	<b>TCR90</b>	900
<b>SCR10</b>	1000	<b>TCR10</b>	1000

CODE

Solid Door

**ANGLED ROBE**

Standard Height

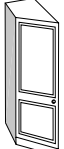

H:2116mm	WIDTH
<b>SAR30</b>	300
<b>SMAR30</b>	300

CODE

Solid Door  
Mirror Door  
Specify LH or RH  
Supplied with four shelves

**ANGLED ROBE**

Tall Height

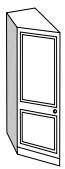

H:2221mm	WIDTH
<b>TAR30</b>	300
<b>TMAR30</b>	300

CODE

Solid Door  
Mirror Door  
Specify LH or RH  
Supplied with four shelves

**STABLE ROBE**

Standard Height

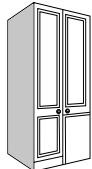

H:2116mm	WIDTH
<b>SSR50</b>	500
<b>SSR10</b>	1000

CODE

Specify LH or RH  
RH Shown

Tall Height

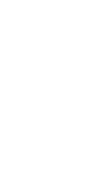

H:2221mm	WIDTH
<b>TSR50</b>	500
<b>TSR10</b>	1000

CODE

Specify LH or RH  
RH Shown

**DIAGONAL ROBE**

Standard Height

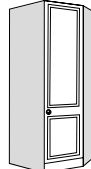

H:2116mm	WIDTH
<b>SDR970</b>	970/970
<b>SMDR970</b>	970/970

CODE

Solid Door  
Mirror Door

Tall Height



H:2221mm	WIDTH
<b>TDR970</b>	970/970
<b>TMDR970</b>	970/970

CODE

Solid Door  
Mirror Door

**COMBINATION ROBE**

Standard Height

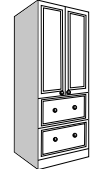

H:2116mm	WIDTH
<b>SCBR240</b>	400
<b>SCBR245</b>	450
<b>SCBR250</b>	500
<b>SCBR280</b>	800
<b>SCBR290</b>	900
<b>SCBR210</b>	1000

CODE

Two Drawers [2x355]

Tall Height



H:2221mm	WIDTH
<b>TCBR240</b>	400
<b>TCBR245</b>	450
<b>TCBR250</b>	500
<b>TCBR280</b>	800
<b>TCBR290</b>	900
<b>TCBR210</b>	1000

CODE

Two Drawers [2x355]

**COMBINATION ROBE**

Standard Height

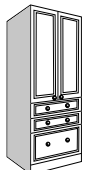

H:2116mm	WIDTH
<b>SCBR340</b>	400
<b>SCBR345</b>	450
<b>SCBR350</b>	500
<b>SCBR380</b>	800
<b>SCBR390</b>	900
<b>SCBR310</b>	1000

CODE

Three Drawers [2x175 & 1x355]

Tall Height



H:2221mm	WIDTH
<b>TCBR340</b>	400
<b>TCBR345</b>	450
<b>TCBR350</b>	500
<b>TCBR380</b>	800
<b>TCBR390</b>	900
<b>TCBR310</b>	1000

CODE

Three Drawers [2x175 & 1x355]

Standard Height

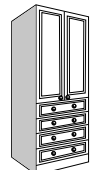

H:2116mm	WIDTH
<b>SCBR440</b>	400
<b>SCBR445</b>	450
<b>SCBR450</b>	500
<b>SCBR480</b>	800
<b>SCBR490</b>	900
<b>SCBR410</b>	1000

CODE

Four Drawers [4x175]

Tall Height



H:2221mm	WIDTH
<b>TCBR440</b>	400
<b>TCBR445</b>	450
<b>TCBR450</b>	500
<b>TCBR480</b>	800
<b>TCBR490</b>	900
<b>TCBR410</b>	1000

CODE

Four Drawers [4x175]

**TALL BOY CHEST**

3 Drawers

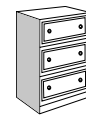

H:1137mm	WIDTH
<b>TBDC360</b>	600
<b>TBDC380</b>	800

CODE

Three Drawers [3x355]

4 Drawers

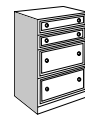

H:1137mm	WIDTH
<b>TBDC460</b>	600
<b>TBDC480</b>	800

CODE

Four Drawers [2x175 & 2x355]

6 Drawers

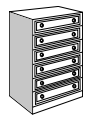

H:1137mm	WIDTH
<b>TBDC660</b>	600
<b>TBDC680</b>	800

CODE

Six Drawers [6x175]

**BRIDGING UNIT**

Scribing Panel

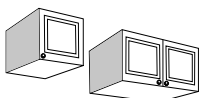

H:459mm	WIDTH
<b>BU40</b>	400
<b>BU45</b>	450
<b>BU50</b>	500
<b>BU80</b>	800
<b>BU90</b>	900
<b>BU10</b>	1000

CODE

H:2400mm	WIDTH
<b>BP2400/655/OH</b>	655

CODE

Fit to the underside of bridging units to match plant-on end panels  
Painted

**STANDARD CABINET**

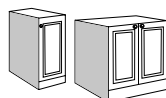

H:778mm	WIDTH
<b>SC30</b>	300
<b>SC35</b>	350
<b>SC40</b>	400
<b>SC45</b>	450
<b>SC50</b>	500
<b>SC60</b>	600
<b>SC80</b>	800

CODE

Excludes chest top

**DRAWLINE CABINET**

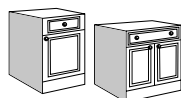

H:778mm	WIDTH
<b>SDC30</b>	300
<b>SDC35</b>	350
<b>SDC40</b>	400
<b>SDC45</b>	450
<b>SDC50</b>	500
<b>SDC60</b>	600
<b>SDC80</b>	800

CODE

Excludes chest top

**CORNER CABINET**

Standard

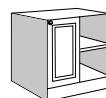

H:778mm	WIDTH
<b>SCC60</b>	600
<b>SCC80</b>	800

CODE

Excludes chest top

**DRAWER CHEST**

2 Drawer



H:778mm	WIDTH
<b>SDC230</b>	300
<b>SDC235</b>	350
<b>SDC240</b>	400
<b>SDC245</b>	450
<b>SDC250</b>	500
<b>SDC260</b>	600
<b>SDC280</b>	800

CODE

Excludes chest top  
Two drawers [2x355]

3 Drawer



H:778mm	WIDTH
<b>SDC330</b>	300
<b>SDC335</b>	350
<b>SDC340</b>	400
<b>SDC345</b>	450
<b>SDC350</b>	500
<b>SDC360</b>	600
<b>SDC380</b>	800

CODE

Excludes chest top  
Three drawers [2x175 & 1x355]

**DRAWER CHEST**

4 Drawer

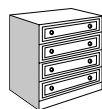

H:778mm

CODE	WIDTH
SDC430	300
SDC435	350
SDC440	400
SDC445	450
SDC450	500
SDC460	600
SDC480	800

Excludes chest top  
Four drawers [4x175]

**BEDSIDE CABINET**



H:598mm

CODE	WIDTH
BSC20	200
BSC30	300
BSC35	350
BSC40	400
BSC45	450
BSC50	500
BSC60	600
BSC80	800

Excludes chest top

**BEDSIDE DRAWER CHEST**

2 Drawer



H:598mm

CODE	WIDTH
BSD230	300
BSD235	350
BSD240	400
BSD245	450
BSD250	500
BSD260	600
BSD280	800

Excludes chest top  
Two drawers [1x175 & 1x355]

3 Drawer



H:598mm

CODE	WIDTH
BSD330	300
BSD335	350
BSD340	400
BSD345	450
BSD350	500
BSD360	600
BSD380	800

Excludes chest top  
Three Drawers [3x175]

**FLOATING DRAWER**

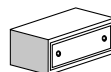

H:359mm

CODE	WIDTH
FBSD40	400
FBSD50	500
FBSD60	600

Excludes chest top  
One drawer [1x355]

**WINDOW SEAT**

1 Drawer



H:418mm

CODE	WIDTH
WDS160	600
WDS180	800

Excludes chest top  
One drawer [1x355]

2 Drawer



H:418mm

CODE	WIDTH
WDS260	600
WDS280	800

Excludes chest top  
Two Drawers [2x175]

**DRESSING TABLE DRAWER**

Single Drawer

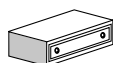

H:180mm

CODE	WIDTH
DTD60	600
DTD70	700
DTD80	800

Excludes chest top  
One drawer [1x175]

**CHEST TOPS**

18mm Painted



Single overhang = one plant-on end panel  
Double overhang = two plant-on end panels

D:520mm

CODE	WIDTH
WT200SO	228
WT200DO	256
WT300SO	328
WT300DO	356
WT350SO	378
WT350DO	406
WT400SO	428

Suits 200 base with Single overhang  
Suits 200 base with Double overhang  
Suits 300 base with Single overhang  
Suits 300 base with Double overhang  
Suits 350 base with Single overhang  
Suits 350 base with Double overhang  
Suits 400 base with Single overhang

CODE	WIDTH
WT400DO	456
WT450SO	478
WT450DO	506
WT500SO	528
WT500DO	556
WT600SO	628
WT600DO	656

Suits 400 base with Double overhang  
Suits 450 base with Single overhang  
Suits 450 base with Double overhang  
Suits 500 base with Single overhang  
Suits 500 base with Double overhang  
Suits 600 base with Single overhang  
Suits 600 base with Double overhang

CODE	WIDTH
WT800SO	828
WT800DO	856
WT1200SO	1228
WT1200DO	1256
WT1600SO	1628
WT1600DO	1656
WT2400	2400

Suits 800 base with Single overhang  
Suits 800 base with Double overhang  
Suits 1200 base with Single overhang  
Suits 1200 base with Double overhang  
Suits 1600 base with Single overhang  
Suits 1600 base with Double overhang

**INTERIOR ROBE**

4 Drawer Chest

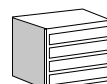

H:735mm

CODE	WIDTH
INT4DR40	400
INT4DR50	500
INT4DR60	600
INT4DR70	700
INT4DR80	800
INT4DR90	900
INT4DR10	1000

Top included

**INTERNAL DIVIDERS**

Standard Height



CODE	WIDTH
ISRD60	600
ISRD70	700
ISRD80	800
ISRD90	900
ISRD10	1000

Consists:  
1 x Vertical Divide & 3 Shelves

Tall Height

CODE	WIDTH
ITRD60	600
ITRD70	700
ITRD80	800
ITRD90	900
ITRD10	1000

Consists:  
1 x Vertical Divide & 3 Shelves

**INTERNAL HANGING RAILS - SPARE**

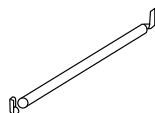

CODE	WIDTH
HR300	300
HR350	350
HR400	400
HR450	450
HR500	500
HR600	600

**INTERNAL SHELVES - SPARE**



CODE	WIDTH
RS300	300
RS350	350
RS400	400
RS450	450
RS500	500
RS600	600

**MODERN CORNICE**



H:49mm

CODE	LENGTH
BCM/OH*	3000

Painted

**PLINTH**



L:3000mm

CODE	HEIGHT
BPL60/OH*	60
BPL100/OH*	100

Scribe to suit on site  
Painted

**INTERIOR MIRROR**



H:1550mm

CODE	WIDTH
IRM	300

Supplied with fixings  
Minimum door width 400

**PLANT ON END PANELS**

18mm Painted



CODE	WIDTH
BP1200/520/OH	520x1200
BP2400/655/OH	655x2400
BP2800/170/OH	170x2800
BP459/665/OH	665x459
BP856/520/OH	520x856

Tall Boy  
Robe  
Flat pelmet/filler  
Bridging unit  
Base cabinet

**EDGING TAPE**



H:22mm

CODE	WIDTH
10ET/OGT	10mtr
3ET/OH	3mtr

Carcase edging / Un-glued  
Painted / Pre-glued



BEDROOMS  
PRICE GROUP 1  
**LUCCO**

Colours Options: Anthracite, Grey Oak, Light Oak and Walnut.



**ROBE**

Standard Height

Tall Height

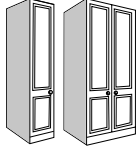

H:2116mm	WIDTH	H:2221mm	WIDTH
CODE	CODE	CODE	CODE
SR30	300	TR30	300
SR35	350	TR35	350
SR40	400	TR40	400
SR45	450	TR45	450
SR50	500	TR50	500
SR60*	600	TR60*	600
SR70	700	TR70	700
SR80	800	TR80	800
SR90	900	TR90	900
SR10	1000	TR10	1000

Solid Door  
\*2 x Doors

Solid Door  
\*2 x Doors

Standard Height

Tall Height

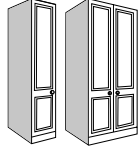

H:2116mm	WIDTH	H:2221mm	WIDTH
CODE	CODE	CODE	CODE
SMR40	400	TMR40	400
SMR45	450	TMR45	450
SMR50	500	TMR50	500
SMR80	800	TMR80	800
SMR90	900	TMR90	900
SMR10	1000	TMR10	1000

Mirror Door  
Mirror Door

**CORNER ROBE**

Standard Height

Tall Height

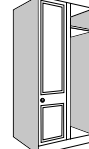

H:2116mm	WIDTH	H:2221mm	WIDTH
CODE	CODE	CODE	CODE
SCR60	600	TCR60	600
SCR80	800	TCR80	800
SCR90	900	TCR90	900
SCR10	1000	TCR10	1000
SMCR80*	800	TMCR80	800
SMCR90*	900	TMCR90	900
SMCR10*	1000	TMCR10	1000

Solid Door  
Solid Door  
Mirror Door

**ANGLED ROBE**

Standard Height

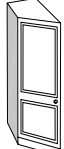

H:2116mm	WIDTH
CODE	CODE
SAR30	300
SMAR30	300

Mirror Door  
Specify LH or RH  
Supplied with four shelves

**ANGLED ROBE**

Tall Height

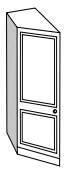

H:2221mm	WIDTH
CODE	CODE
TAR30	300
TMAR30	300

Solid Door  
Mirror Door  
Specify LH or RH  
Supplied with four shelves

**STABLE ROBE**

Standard Height

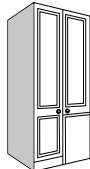

H:2116mm	WIDTH
CODE	CODE
SSR10	1000
SSR50	500

Specify LH or RH  
RH Shown

Tall Height



H:2221mm	WIDTH
CODE	CODE
TSR10	1000
TSR50	500

Specify LH or RH  
RH Shown

**DIAGONAL ROBE**

Standard Height

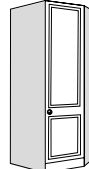

H:2116mm	WIDTH
CODE	CODE
SDR970	970/970
SMDR970	970/970

Solid Door  
Mirror Door

Tall Height



H:2221mm	WIDTH
CODE	CODE
TDR970	970/970
TMDR970	970/970

Solid Door  
Mirror Door

**COMBINATION ROBE**

Standard Height

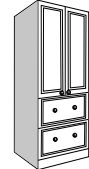

H:2116mm	WIDTH
CODE	CODE
SCBR240	400
SCBR245	450
SCBR250	500
SCBR280	800
SCBR290	900
SCBR210	1000

Two Drawers [2x355]

Tall Height



H:2221mm	WIDTH
CODE	CODE
TCBR240	400
TCBR245	450
TCBR250	500
TCBR280	800
TCBR290	900
TCBR210	1000

Two Drawers [2x355]

**COMBINATION ROBE**

Standard Height

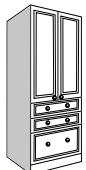

H:2116mm	WIDTH
CODE	CODE
SCBR340	400
SCBR345	450
SCBR350	500
SCBR380	800
SCBR390	900
SCBR310	1000

Three Drawers [2x175 & 1x355]

Tall Height



H:2221mm	WIDTH
CODE	CODE
TCBR340	400
TCBR345	450
TCBR350	500
TCBR380	800
TCBR390	900
TCBR310	1000

Three Drawers [2x175 & 1x355]

Standard Height

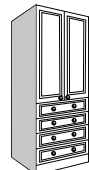

H:2116mm	WIDTH
CODE	CODE
SCBR440	400
SCBR445	450
SCBR450	500
SCBR480	800
SCBR490	900
SCBR410	1000

Four Drawers [4x175]

Tall Height



H:2221mm	WIDTH
CODE	CODE
TCBR440	400
TCBR445	450
TCBR450	500
TCBR480	800
TCBR490	900
TCBR410	1000

Four Drawers [4x175]

**TALL BOY CHEST**

3 Drawers

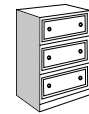

H:1137mm	WIDTH
CODE	CODE
TBDC360	600
TBDC380	800

Three Drawers [3x355]

4 Drawers

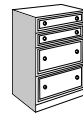

H:1137mm	WIDTH
CODE	CODE
TBDC460	600
TBDC480	800

Four Drawers [2x175 & 2x355]

6 Drawers

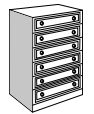

H:1137mm	WIDTH
CODE	CODE
TBDC660	600
TBDC680	800

Six Drawers [6x175]

**BRIDGING UNIT**

Scribing Panel

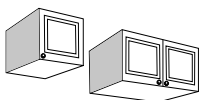

H:459mm	WIDTH	H:2400mm	WIDTH
CODE	CODE	CODE	CODE
BU40	400	BP2400/655/O	655
BU45	450		
BU50	500		
BU80	800		
BU90	900		
BU10	1000		

Fit to the underside of bridging units to match plant-on end panels  
MFC

**STANDARD CABINET**

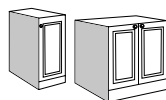

H:778mm	WIDTH
CODE	CODE
SC30	300
SC35	350
SC40	400
SC45	450
SC50	500
SC60	600
SC80	800

Excludes chest top

**DRAWLINE CABINET**

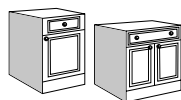

H:778mm	WIDTH
CODE	CODE
SDC30	300
SDC35	350
SDC40	400
SDC45	450
SDC50	500
SDC60	600
SDC80	800

Excludes chest top

**CORNER CABINET**

Standard

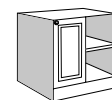

H:778mm	WIDTH
CODE	CODE
SCC60	600
SCC80	800

Excludes chest top

**DRAWER CHEST**

2 Drawer



H:778mm	WIDTH
CODE	CODE
SDC230	300
SDC235	350
SDC240	400
SDC245	450
SDC250	500
SDC260	600
SDC280	800

Excludes chest top  
Two drawers [2x355]

3 Drawer



H:778mm	WIDTH
CODE	CODE
SDC330	300
SDC335	350
SDC340	400
SDC345	450
SDC350	500
SDC360	600
SDC380	800

Excludes chest top  
Three drawers [2x175 & 1x355]

**DRAWER CHEST**

4 Drawer

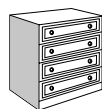

H:778mm

CODE	WIDTH
SDC430	300
SDC435	350
SDC440	400
SDC445	450
SDC450	500
SDC460	600
SDC480	800

Excludes chest top  
Four drawers [4x175]

**BEDSIDE CABINET**



H:598mm

CODE	WIDTH
BSC20	200
BSC30	300
BSC35	350
BSC40	400
BSC45	450
BSC50	500
BSC60	600
BSC80	800

Excludes chest top

**BEDSIDE DRAWER CHEST**

2 Drawer



H:598mm

CODE	WIDTH
BSD230	300
BSD235	350
BSD240	400
BSD245	450
BSD250	500
BSD260	600
BSD280	800

Excludes chest top  
Two drawers [1x175 & 1x355]

3 Drawer



H:598mm

CODE	WIDTH
BSD330	300
BSD335	350
BSD340	400
BSD345	450
BSD350	500
BSD360	600
BSD380	800

Excludes chest top  
Three Drawers [3x175]

**FLOATING DRAWER**

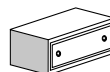

H:359mm

CODE	WIDTH
FBSD40	400
FBSD50	500
FBSD60	600

Excludes chest top  
One drawer [1x355]

**WINDOW SEAT**

1 Drawer



H:418mm

CODE	WIDTH
WDS160	600
WDS180	800

Excludes chest top  
One drawer [1x355]

2 Drawer



H:418mm

CODE	WIDTH
WDS260	600
WDS280	800

Excludes chest top  
Two Drawers [2x175]

**DRESSING TABLE DRAWER**

Single Drawer

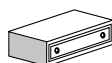

H:180mm

CODE	WIDTH
DTD60	600
DTD70	700
DTD80	800

Excludes chest top  
One drawer [1x175]

**CHEST TOPS**

18mm MFC



Single overhang = one plant-on end panel  
Double overhang = two plant-on end panels

D:520mm

CODE	WIDTH
WT200SO	228
WT200DO	256
WT300SO	328
WT300DO	356
WT350SO	378
WT350DO	406
WT400SO	428

Suits 200 base with Single overhang  
Suits 200 base with Double overhang  
Suits 300 base with Single overhang  
Suits 300 base with Double overhang  
Suits 350 base with Single overhang  
Suits 350 base with Double overhang  
Suits 400 base with Single overhang

CODE	WIDTH
WT400DO	456
WT450SO	478
WT450DO	506
WT500SO	528
WT500DO	556
WT600SO	628
WT600DO	656

Suits 400 base with Double overhang  
Suits 450 base with Single overhang  
Suits 450 base with Double overhang  
Suits 500 base with Single overhang  
Suits 500 base with Double overhang  
Suits 600 base with Single overhang  
Suits 600 base with Double overhang

CODE	WIDTH
WT800SO	828
WT800DO	856
WT1200SO	1228
WT1200DO	1256
WT1600SO	1628
WT1600DO	1656
WT2400	2400

Suits 800 base with Single overhang  
Suits 800 base with Double overhang  
Suits 1200 base with Single overhang  
Suits 1200 base with Double overhang  
Suits 1600 base with Single overhang  
Suits 1600 base with Double overhang

**INTERIOR ROBE**

4 Drawer Chest

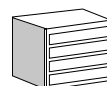

H:735mm

CODE	WIDTH
INT4DR40	400
INT4DR50	500
INT4DR60	600
INT4DR70	700
INT4DR80	800
INT4DR90	900
INT4DR10	1000

Top included

**INTERNAL DIVIDERS**

Standard Height



CODE	WIDTH
ISRD60	600
ISRD70	700
ISRD80	800
ISRD90	900
ISRD10	1000

Consists:  
1 x Vertical Divide & 3 Shelves

Tall Height

CODE	WIDTH
ITRD60	600
ITRD70	700
ITRD80	800
ITRD90	900
ITRD10	1000

Consists:  
1 x Vertical Divide & 3 Shelves

**INTERNAL HANGING RAILS - SPARE**

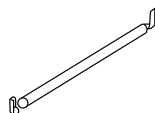

CODE	WIDTH
HR300	300
HR350	350
HR400	400
HR450	450
HR500	500
HR600	600

**INTERNAL SHELVES - SPARE**



CODE	WIDTH
RS300	300
RS350	350
RS400	400
RS450	450
RS500	500
RS600	600

**FLAT CORNICE**

18mm MFC



L:2800mm

CODE	DEPTH
BCM/O*	60

MFC

**PLINTH**



L:2800mm

CODE	HEIGHT
BPL60/O*	60
BPL100/O*	100

Scribe to suit on site  
MFC

**INTERIOR MIRROR**

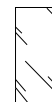

H:1550mm

CODE	WIDTH
IRM	300

Supplied with fixings  
Minimum door width 400

**PLANT ON END PANELS**

18mm MFC



CODE	WIDTH
BP1200/520/O	520x1200
BP2400/655/O	655x2400
BP2800/170/O	170x2800
BP459/665/O	665x459
BP856/520/O	520x856

Tall Boy  
Robe  
Flat pelmet/filler  
Bridging unit  
Base cabinet

**EDGING TAPE**



H:22mm

CODE	WIDTH
10ET/OGT	10mtr
10ET/O	10mtr

Carcase edging / Un-glued  
Plant-on panel/ chest top edging / Pre-glued

**BEDROOMS**  
**PRICE GROUP 4**  
**NOTO**

Colours Options: Dust Grey, Grey, Oyster and White.



**ROBE**

Standard Height

Tall Height

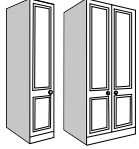

H:2116mm	WIDTH	H:2221mm	WIDTH
<b>SR30</b>	300	<b>TR30</b>	300
<b>SR35</b>	350	<b>TR35</b>	350
<b>SR40</b>	400	<b>TR40</b>	400
<b>SR45</b>	450	<b>TR45</b>	450
<b>SR50</b>	500	<b>TR50</b>	500
<b>SR60*</b>	600	<b>TR60*</b>	600
<b>SR70</b>	700	<b>TR70</b>	700
<b>SR80</b>	800	<b>TR80</b>	800
<b>SR90</b>	900	<b>TR90</b>	900
<b>SR10</b>	1000	<b>TR10</b>	1000

Solid Door  
 \*2 x Doors  
 Solid Door  
 \*2 x Doors

Standard Height

Tall Height

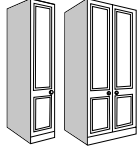

H:2116mm	WIDTH	H:2221mm	WIDTH
<b>SMR40</b>	400	<b>TMR40</b>	400
<b>SMR45</b>	450	<b>TMR45</b>	450
<b>SMR50</b>	500	<b>TMR50</b>	500
<b>SMR80</b>	800	<b>TMR80</b>	800
<b>SMR90</b>	900	<b>TMR90</b>	900
<b>SMR10</b>	1000	<b>TMR10</b>	1000

Mirror Door  
 Mirror Door

**CORNER ROBE**

Standard Height

Tall Height

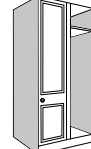

H:2116mm	WIDTH	H:2221mm	WIDTH
<b>SCR60</b>	600	<b>TCR60</b>	600
<b>SCR80</b>	800	<b>TCR80</b>	800
<b>SCR90</b>	900	<b>TCR90</b>	900
<b>SCR10</b>	1000	<b>TCR10</b>	1000

Solid Door  
 Solid Door  
 Solid Door  
 Mirror Door

**ANGLED ROBE**

Standard Height

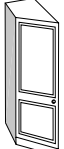

H:2116mm	WIDTH
<b>SAR30</b>	300
<b>SMAR30</b>	300

Mirror Door  
 Specify LH or RH  
 Supplied with four shelves

**ANGLED ROBE**

Tall Height

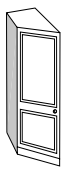

H:2221mm	WIDTH
<b>TAR30</b>	300

Solid Door  
**TMAR30** 300  
 Mirror Door  
 Specify LH or RH  
 Supplied with four shelves

**STABLE ROBE**

Standard Height

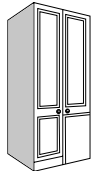

H:2116mm	WIDTH
<b>SSR50</b>	500
<b>SSR10</b>	1000

Specify LH or RH  
 RH Shown

**DIAGONAL ROBE**

Standard Height

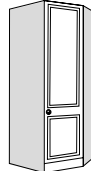

H:2116mm	WIDTH
<b>SDR970</b>	970/970
<b>SMDR970</b>	970/970

Solid Door  
 Mirror Door

**COMBINATION ROBE**

Standard Height

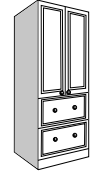

H:2116mm	WIDTH	H:2221mm	WIDTH
<b>SCBR240</b>	400	<b>TCBR240</b>	400
<b>SCBR245</b>	450	<b>TCBR245</b>	450
<b>SCBR250</b>	500	<b>TCBR250</b>	500
<b>SCBR280</b>	800	<b>TCBR280</b>	800
<b>SCBR290</b>	900	<b>TCBR290</b>	900
<b>SCBR210</b>	1000	<b>TCBR210</b>	1000

Two Drawers [2x355]  
 Two Drawers [2x355]

**COMBINATION ROBE**

Standard Height

Tall Height

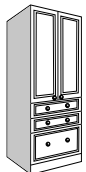

H:2116mm	WIDTH	H:2221mm	WIDTH
<b>SCBR340</b>	400	<b>TCBR340</b>	400
<b>SCBR345</b>	450	<b>TCBR345</b>	450
<b>SCBR350</b>	500	<b>TCBR350</b>	500
<b>SCBR380</b>	800	<b>TCBR380</b>	800
<b>SCBR390</b>	900	<b>TCBR390</b>	900
<b>SCBR310</b>	1000	<b>TCBR310</b>	1000

Three Drawers [2x175 & 1x355]  
 Three Drawers [2x175 & 1x355]

Standard Height

Tall Height

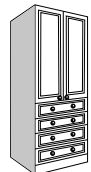

H:2116mm	WIDTH	H:2221mm	WIDTH
<b>SCBR440</b>	400	<b>TCBR440</b>	400
<b>SCBR445</b>	450	<b>TCBR445</b>	450
<b>SCBR450</b>	500	<b>TCBR450</b>	500
<b>SCBR480</b>	800	<b>TCBR480</b>	800
<b>SCBR490</b>	900	<b>TCBR490</b>	900
<b>SCBR410</b>	1000	<b>TCBR410</b>	1000

Four Drawers [4x175]  
 Four Drawers [4x175]

**TALL BOY CHEST**

3 Drawers



H:1137mm	WIDTH
<b>TBDC360</b>	600
<b>TBDC380</b>	800

Three Drawers [3x355]

4 Drawers

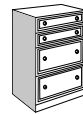

H:1137mm	WIDTH
<b>TBDC460</b>	600
<b>TBDC480</b>	800

Four Drawers [2x175 & 2x355]

6 Drawers

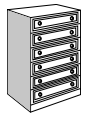

H:1137mm	WIDTH
<b>TBDC660</b>	600
<b>TBDC680</b>	800

Six Drawers [6x175]

**BRIDGING UNIT**

Scribing Panel

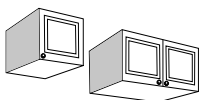

H:459mm	WIDTH	H:2400mm	WIDTH
<b>BU40</b>	400	<b>BP2400/655/O</b>	655
<b>BU45</b>	450		
<b>BU50</b>	500		
<b>BU80</b>	800		
<b>BU90</b>	900		
<b>BU10</b>	1000		

Fit to the underside of bridging units to match plant-on end panels  
 Foil

**STANDARD CABINET**

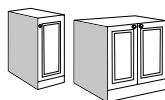

H:778mm	WIDTH	H:778mm	WIDTH
<b>SC30</b>	300	<b>SDC30</b>	300
<b>SC35</b>	350	<b>SDC35</b>	350
<b>SC40</b>	400	<b>SDC40</b>	400
<b>SC45</b>	450	<b>SDC45</b>	450
<b>SC50</b>	500	<b>SDC50</b>	500
<b>SC60</b>	600	<b>SDC60</b>	600
<b>SC80</b>	800	<b>SDC80</b>	800

Excludes chest top  
 Excludes chest top

**DRAWLINE CABINET**

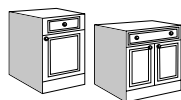

**CORNER CABINET**

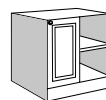

H:778mm	WIDTH
<b>SCC60</b>	600
<b>SCC80</b>	800

Excludes chest top

**DRAWER CHEST**

2 Drawer



H:778mm	WIDTH
<b>SDC230</b>	300
<b>SDC235</b>	350
<b>SDC240</b>	400
<b>SDC245</b>	450
<b>SDC250</b>	500
<b>SDC260</b>	600
<b>SDC280</b>	800

Excludes chest top  
 Two drawers [2x355]

3 Drawer



H:778mm	WIDTH
<b>SDC330</b>	300
<b>SDC335</b>	350
<b>SDC340</b>	400
<b>SDC345</b>	450
<b>SDC350</b>	500
<b>SDC360</b>	600
<b>SDC380</b>	800

Excludes chest top  
 Three drawers [2x175 & 1x355]

**DRAWER CHEST**

4 Drawer

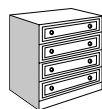

H:778mm

CODE	WIDTH
SDC430	300
SDC435	350
SDC440	400
SDC445	450
SDC450	500
SDC460	600
SDC480	800

Excludes chest top  
Four drawers [4x175]

**BEDSIDE CABINET**



H:598mm

CODE	WIDTH
BSC20	200
BSC30	300
BSC35	350
BSC40	400
BSC45	450
BSC50	500
BSC60	600
BSC80	800

Excludes chest top

**BEDSIDE DRAWER CHEST**

2 Drawer



H:598mm

CODE	WIDTH
BSD230	300
BSD235	350
BSD240	400
BSD245	450
BSD250	500
BSD260	600
BSD280	800

Excludes chest top  
Two drawers [1x175 & 1x355]

3 Drawer



H:598mm

CODE	WIDTH
BSD330	300
BSD335	350
BSD340	400
BSD345	450
BSD350	500
BSD360	600
BSD380	800

Excludes chest top  
Three Drawers [3x175]

**FLOATING DRAWER**

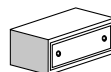

H:359mm

CODE	WIDTH
FBSD40	400
FBSD50	500
FBSD60	600

Excludes chest top  
One drawer [1x355]

**WINDOW SEAT**

1 Drawer



H:418mm

CODE	WIDTH
WDS160	600
WDS180	800

Excludes chest top  
One drawer [1x355]

2 Drawer



H:418mm

CODE	WIDTH
WDS260	600
WDS280	800

Excludes chest top  
Two Drawers [2x175]

**DRESSING TABLE DRAWER**

Single Drawer

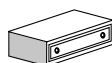

H:180mm

CODE	WIDTH
DTD60	600
DTD70	700
DTD80	800

Excludes chest top  
One drawer [1x175]

**CHEST TOPS**

18mm Foil



Single overhang = one plant-on end panel  
Double overhang = two plant-on end panels

D:520mm

CODE	WIDTH
WT200SO	228
WT200DO	256
WT300SO	328
WT300DO	356
WT350SO	378
WT350DO	406
WT400SO	428

Suits 200 base with Single overhang  
Suits 200 base with Double overhang  
Suits 300 base with Single overhang  
Suits 300 base with Double overhang  
Suits 350 base with Single overhang  
Suits 350 base with Double overhang  
Suits 400 base with Single overhang

CODE	WIDTH
WT400DO	456
WT450SO	478
WT450DO	506
WT500SO	528
WT500DO	556
WT600SO	628
WT600DO	656

Suits 400 base with Double overhang  
Suits 450 base with Single overhang  
Suits 450 base with Double overhang  
Suits 500 base with Single overhang  
Suits 500 base with Double overhang  
Suits 600 base with Single overhang  
Suits 600 base with Double overhang

CODE	WIDTH
WT800SO	828
WT800DO	856
WT1200SO	1228
WT1200DO	1256
WT1600SO	1628
WT1600DO	1656
WT2400	2400

Suits 800 base with Single overhang  
Suits 800 base with Double overhang  
Suits 1200 base with Single overhang  
Suits 1200 base with Double overhang  
Suits 1600 base with Single overhang  
Suits 1600 base with Double overhang

**INTERIOR ROBE**

4 Drawer Chest

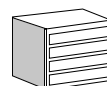

H:735mm

CODE	WIDTH
INT4DR40	400
INT4DR50	500
INT4DR60	600
INT4DR70	700
INT4DR80	800
INT4DR90	900
INT4DR10	1000

Top included

**INTERNAL DIVIDERS**

Standard Height



CODE	WIDTH
ISRD60	600
ISRD70	700
ISRD80	800
ISRD90	900
ISRD10	1000

Consists:  
1 x Vertical Divide & 3 Shelves

Tall Height

CODE	WIDTH
ITRD60	600
ITRD70	700
ITRD80	800
ITRD90	900
ITRD10	1000

Consists:  
1 x Vertical Divide & 3 Shelves

**INTERNAL HANGING RAILS - SPARE**

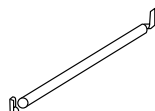

CODE	WIDTH
HR300	300
HR350	350
HR400	400
HR450	450
HR500	500
HR600	600

**INTERNAL SHELVES - SPARE**



CODE	WIDTH
HR700	700
HR800	800
HR900	900
HR1000	1000
HRD*	

\*Diagonal Robe

CODE	WIDTH
RS300	300
RS350	350
RS400	400
RS450	450
RS500	500
RS600	600

\*Diagonal Robe

**MODERN CORNICE**



H:33mm

CODE	LENGTH
BCM/O*	3000

Foil

**PLINTH**



L:3000mm

CODE	HEIGHT
BPL60/O*	60
BPL100/O*	100

Scribe to suit on site  
Foil

**INTERIOR MIRROR**

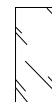

H:1550mm

CODE	WIDTH
IRM	300

Supplied with fixings  
Minimum door width 400

**PLANT ON END PANELS**

18mm MFC



CODE	WIDTH
BP1200/520/O	520x1200
BP2400/655/O	655x2400
BP2800/170/O	170x2800
BP459/665/O	665x459
BP856/520/O	520x856

Tall Boy  
Robe  
Flat pelmet/filler  
Bridging unit  
Base cabinet

**EDGING TAPE**



H:22mm

CODE	WIDTH
10ET/OGT	10mtr
10ET/O	10mtr

Carcase edging / Un-glued  
Plant-on panel/ chest top edging / Pre-glued

BEDROOMS  
PRICE GROUP 2  
**PELLARO**

Colours Options: Grey



**ROBE**

Standard Height

Tall Height

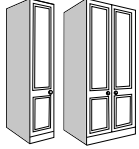

H:2116mm		H:2221mm	
CODE	WIDTH	CODE	WIDTH
SR30	300	TR30	300
SR35	350	TR35	350
SR40	400	TR40	400
SR45	450	TR45	450
SR50	500	TR50	500
SR60*	600	TR60*	600
SR70	700	TR70	700
SR80	800	TR80	800
SR90	900	TR90	900
SR10	1000	TR10	1000

Solid Door  
\*2 x Doors

Solid Door  
\*2 x Doors

Standard Height

Tall Height

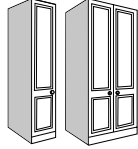

H:2116mm		H:2221mm	
CODE	WIDTH	CODE	WIDTH
SMR40	400	TMR40	400
SMR45	450	TMR45	450
SMR50	500	TMR50	500
SMR80	800	TMR80	800
SMR90	900	TMR90	900
SMR10	1000	TMR10	1000

Mirror Door

Mirror Door

**CORNER ROBE**

Standard Height

Tall Height

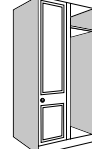

H:2116mm		H:2221mm	
CODE	WIDTH	CODE	WIDTH
SCR60	600	TCR60	600
SCR80	800	TCR80	800
SCR90	900	TCR90	900
SCR10	1000	TCR10	1000

Solid Door

Solid Door

**ANGLED ROBE**

Standard Height

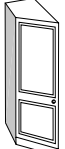

H:2116mm	
CODE	WIDTH
SAR30	300
SMAR30	300

Mirror Door  
Specify LH or RH  
Supplied with four shelves

**ANGLED ROBE**

Tall Height

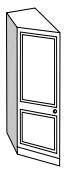

H:2221mm	
CODE	WIDTH
TAR30	300

Solid Door

TMAR30 300

Mirror Door

Specify LH or RH  
Supplied with four shelves

**STABLE ROBE**

Standard Height

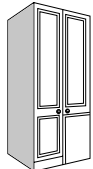

H:2116mm	
CODE	WIDTH
SSR50	500
SSR10	1000

Specify LH or RH  
RH Shown

**DIAGONAL ROBE**

Standard Height

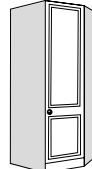

H:2116mm	
CODE	WIDTH
SDR970	970/970
SMDR970	970/970

Solid Door

Mirror Door

**COMBINATION ROBE**

Standard Height

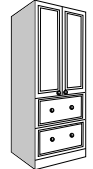

H:2116mm		H:2221mm	
CODE	WIDTH	CODE	WIDTH
SCBR240	400	TCBR240	400
SCBR245	450	TCBR245	450
SCBR250	500	TCBR250	500
SCBR280	800	TCBR280	800
SCBR290	900	TCBR290	900
SCBR210	1000	TCBR210	1000

Two Drawers [2x355]

Two Drawers [2x355]

**COMBINATION ROBE**

Standard Height

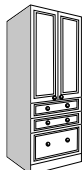

H:2116mm	
CODE	WIDTH
SCBR340	400
SCBR345	450
SCBR350	500
SCBR380	800
SCBR390	900
SCBR310	1000

Three Drawers [2x175 & 1x355]

Tall Height



H:2221mm	
CODE	WIDTH
TCBR340	400
TCBR345	450
TCBR350	500
TCBR380	800
TCBR390	900
TCBR310	1000

Three Drawers [2x175 & 1x355]

Standard Height

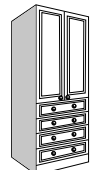

H:2116mm	
CODE	WIDTH
SCBR440	400
SCBR445	450
SCBR450	500
SCBR480	800
SCBR490	900
SCBR410	1000

Four Drawers [4x175]

Tall Height



H:2221mm	
CODE	WIDTH
TCBR440	400
TCBR445	450
TCBR450	500
TCBR480	800
TCBR490	900
TCBR410	1000

Four Drawers [4x175]

**TALL BOY CHEST**

3 Drawers

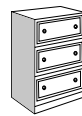

H:1137mm	
CODE	WIDTH
TBDC360	600
TBDC380	800

Three Drawers [3x355]

4 Drawers

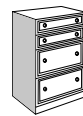

H:1137mm	
CODE	WIDTH
TBDC460	600
TBDC480	800

Four Drawers [2x175 & 2x355]

6 Drawers

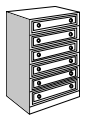

H:1137mm	
CODE	WIDTH
TBDC660	600
TBDC680	800

Six Drawers [6x175]

**BRIDGING UNIT**

Scribing Panel

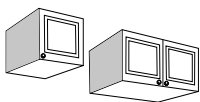

H:459mm		H:2400mm	
CODE	WIDTH	CODE	WIDTH
BU40	400	BP2400/655/O	655
BU45	450	Fit to the underside of bridging units to match plant-on end panels	
BU50	500	Foil	
BU80	800		
BU90	900		
BU10	1000		

**STANDARD CABINET**

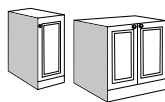

H:778mm	
CODE	WIDTH
SC30	300
SC35	350
SC40	400
SC45	450
SC50	500
SC60	600
SC80	800

Excludes chest top

**DRAWLINE CABINET**

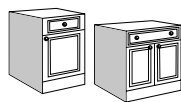

H:778mm	
CODE	WIDTH
SDC30	300
SDC35	350
SDC40	400
SDC45	450
SDC50	500
SDC60	600
SDC80	800

Excludes chest top

**CORNER CABINET**

Standard

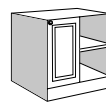

H:778mm	
CODE	WIDTH
SCC60	600
SCC80	800

Excludes chest top

**DRAWER CHEST**

2 Drawer



H:778mm	
CODE	WIDTH
SDC230	300
SDC235	350
SDC240	400
SDC245	450
SDC250	500
SDC260	600
SDC280	800

Excludes chest top  
Two drawers [2x355]

3 Drawer



H:778mm	
CODE	WIDTH
SDC330	300
SDC335	350
SDC340	400
SDC345	450
SDC350	500
SDC360	600
SDC380	800

Excludes chest top  
Three drawers [2x175 & 1x355]



**DRAWER CHEST**

4 Drawer

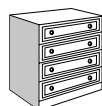

H:778mm

CODE	WIDTH
SDC430	300
SDC435	350
SDC440	400
SDC445	450
SDC450	500
SDC460	600
SDC480	800

Excludes chest top  
Four drawers [4x175]

**BEDSIDE CABINET**



H:598mm

CODE	WIDTH
BSC20	200
BSC30	300
BSC35	350
BSC40	400
BSC45	450
BSC50	500
BSC60	600
BSC80	800

Excludes chest top

**BEDSIDE DRAWER CHEST**

2 Drawer



H:598mm

CODE	WIDTH
BSD230	300
BSD235	350
BSD240	400
BSD245	450
BSD250	500
BSD260	600
BSD280	800

Excludes chest top  
Two drawers [1x175 & 1x355]

3 Drawer



H:598mm

CODE	WIDTH
BSD330	300
BSD335	350
BSD340	400
BSD345	450
BSD350	500
BSD360	600
BSD380	800

Excludes chest top  
Three Drawers [3x175]

**FLOATING DRAWER**

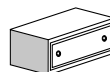

H:359mm

CODE	WIDTH
FBSD40	400
FBSD50	500
FBSD60	600

Excludes chest top  
One drawer [1x355]

**WINDOW SEAT**

1 Drawer



H:418mm

CODE	WIDTH
WDS160	600
WDS180	800

Excludes chest top  
One drawer [1x355]

2 Drawer



H:418mm

CODE	WIDTH
WDS260	600
WDS280	800

Excludes chest top  
Two Drawers [2x175]

**DRESSING TABLE DRAWER**

Single Drawer

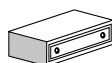

H:180mm

CODE	WIDTH
DTD60	600
DTD70	700
DTD80	800

Excludes chest top  
One drawer [1x175]

**CHEST TOPS**

18mm Foil



Single overhang = one plant-on end panel  
Double overhang = two plant-on end panels

D:520mm

CODE	WIDTH
WT200SO	228
WT200DO	256
WT300SO	328
WT300DO	356
WT350SO	378
WT350DO	406
WT400SO	428

Suits 200 base with Single overhang  
Suits 200 base with Double overhang  
Suits 300 base with Single overhang  
Suits 300 base with Double overhang  
Suits 350 base with Single overhang  
Suits 350 base with Double overhang  
Suits 400 base with Single overhang

CODE	WIDTH
WT400DO	456
WT450SO	478
WT450DO	506
WT500SO	528
WT500DO	556
WT600SO	628
WT600DO	656

Suits 400 base with Double overhang  
Suits 450 base with Single overhang  
Suits 450 base with Double overhang  
Suits 500 base with Single overhang  
Suits 500 base with Double overhang  
Suits 600 base with Single overhang  
Suits 600 base with Double overhang

CODE	WIDTH
WT800SO	828
WT800DO	856
WT1200SO	1228
WT1200DO	1256
WT1600SO	1628
WT1600DO	1656
WT2400	2400

Suits 800 base with Single overhang  
Suits 800 base with Double overhang  
Suits 1200 base with Single overhang  
Suits 1200 base with Double overhang  
Suits 1600 base with Single overhang  
Suits 1600 base with Double overhang

**INTERIOR ROBE**

4 Drawer Chest

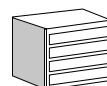

H:735mm

CODE	WIDTH
INT4DR40	400
INT4DR50	500
INT4DR60	600
INT4DR70	700
INT4DR80	800
INT4DR90	900
INT4DR10	1000

Top included

**INTERNAL DIVIDERS**

Standard Height



CODE	WIDTH
ISRD60	600
ISRD70	700
ISRD80	800
ISRD90	900
ISRD10	1000

Consists:  
1 x Vertical Divide & 3 Shelves

Tall Height

CODE	WIDTH
ITRD60	600
ITRD70	700
ITRD80	800
ITRD90	900
ITRD10	1000

Consists:  
1 x Vertical Divide & 3 Shelves

**INTERNAL HANGING RAILS - SPARE**

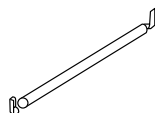

CODE	WIDTH
HR300	300
HR350	350
HR400	400
HR450	450
HR500	500
HR600	600

**INTERNAL SHELVES - SPARE**



CODE	WIDTH
RS300	300
RS350	350
RS400	400
RS450	450
RS500	500
RS600	600

**MODERN CORNICE**

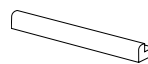

H:33mm

CODE	LENGTH
BCM/O*	3000

Foil

**PLINTH**



L:2750mm

CODE	HEIGHT
BPL60/O*	60
BPL100/O*	100

Scribe to suit on site  
Foil

**INTERIOR MIRROR**

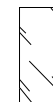

H:1550mm

CODE	WIDTH
IRM	300

Supplied with fixings  
Minimum door width 400

**PLANT ON END PANELS**

18mm MFC



CODE	WIDTH
BP1200/520/O	520x1200
BP2400/655/O	655x2400
BP2800/170/O	170x2800
BP459/665/O	665x459
BP856/520/O	520x856

Tall Boy  
Robe  
Flat pelmet/filler  
Bridging unit  
Base cabinet

**EDGING TAPE**



H:22mm

CODE	WIDTH
10ET/OGT	10mtr
10ET/O	10mtr

Carcase edging / Un-glued  
Plant-on panel/ chest top edging / Pre-glued

BEDROOMS

PRICE GROUP 2

SASSARI

Colours Options: Cashmere, Dust Grey, Grey, Oyster and White.



ROBE

Standard Height

Tall Height

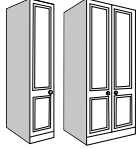

H:2116mm	WIDTH	H:2221mm	WIDTH
SR30	300	TR30	300
SR35	350	TR35	350
SR40	400	TR40	400
SR45	450	TR45	450
SR50	500	TR50	500
SR60*	600	TR60*	600
SR70	700	TR70	700
SR80	800	TR80	800
SR90	900	TR90	900
SR10	1000	TR10	1000

Solid Door  
\*2 x Doors

Solid Door  
\*2 x Doors

Standard Height

Tall Height

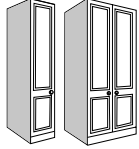

H:2116mm	WIDTH	H:2221mm	WIDTH
SMR40	400	TMR40	400
SMR45	450	TMR45	450
SMR50	500	TMR50	500
SMR80	800	TMR80	800
SMR90	900	TMR90	900
SMR10	1000	TMR10	1000

Mirror Door  
Mirror Door

CORNER ROBE

Standard Height

Tall Height

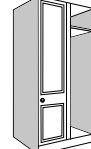

H:2116mm	WIDTH	H:2221mm	WIDTH
SCR60	600	TCR60	600
SCR80	800	TCR80	800
SCR90	900	TCR90	900
SCR10	1000	TCR10	1000

Solid Door  
Solid Door

SMCR80\* 800  
SMCR90\* 900  
SMCR10\* 1000  
Mirror Door

TMCR80 800  
TMCR90 900  
TMCR10 1000  
Mirror Door

ANGLED ROBE

Standard Height

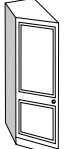

H:2116mm	WIDTH
SAR30	300
SMAR30	300

Mirror Door  
Specify LH or RH  
Supplied with four shelves

ANGLED ROBE

Tall Height

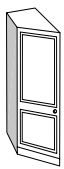

H:2221mm	WIDTH
TAR30	300
TMAR30	300

Solid Door  
Mirror Door  
Specify LH or RH  
Supplied with four shelves

STABLE ROBE

Standard Height

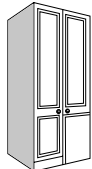

H:2116mm	WIDTH
SSR50	500
SSR10	1000

Specify LH or RH  
RH Shown

DIAGONAL ROBE

Standard Height

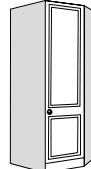

H:2116mm	WIDTH
SDR970	970/970
SMDR970	970/970

Solid Door  
Mirror Door

COMBINATION ROBE

Standard Height

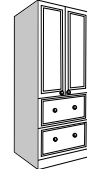

H:2116mm	WIDTH	H:2221mm	WIDTH
SCBR240	400	TCBR240	400
SCBR245	450	TCBR245	450
SCBR250	500	TCBR250	500
SCBR280	800	TCBR280	800
SCBR290	900	TCBR290	900
SCBR210	1000	TCBR210	1000

Two Drawers [2x355]  
Two Drawers [2x355]

COMBINATION ROBE

Standard Height

Tall Height

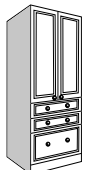

H:2116mm	WIDTH	H:2221mm	WIDTH
SCBR340	400	TCBR340	400
SCBR345	450	TCBR345	450
SCBR350	500	TCBR350	500
SCBR380	800	TCBR380	800
SCBR390	900	TCBR390	900
SCBR310	1000	TCBR310	1000

Three Drawers [2x175 & 1x355]  
Three Drawers [2x175 & 1x355]

Standard Height

Tall Height

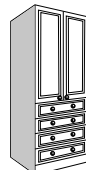

H:2116mm	WIDTH	H:2221mm	WIDTH
SCBR440	400	TCBR440	400
SCBR445	450	TCBR445	450
SCBR450	500	TCBR450	500
SCBR480	800	TCBR480	800
SCBR490	900	TCBR490	900
SCBR410	1000	TCBR410	1000

Four Drawers [4x175]  
Four Drawers [4x175]

TALL BOY CHEST

3 Drawers

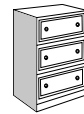

H:1137mm	WIDTH
TBDC360	600
TBDC380	800

Three Drawers [3x355]

4 Drawers

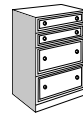

H:1137mm	WIDTH
TBDC460	600
TBDC480	800

Four Drawers [2x175 & 2x355]

6 Drawers

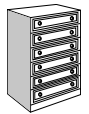

H:1137mm	WIDTH
TBDC660	600
TBDC680	800

Six Drawers [6x175]

BRIDGING UNIT

Scribing Panel

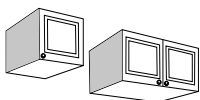

H:459mm	WIDTH	H:2400mm	WIDTH
BU40	400	BP2400/655/O	655
BU45	450		
BU50	500		
BU80	800		
BU90	900		
BU10	1000		

Fit to the underside of bridging units to match plant-on end panels  
Foil

STANDARD CABINET

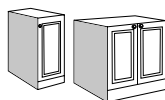

H:778mm	WIDTH	H:778mm	WIDTH
SC30	300	SDC30	300
SC35	350	SDC35	350
SC40	400	SDC40	400
SC45	450	SDC45	450
SC50	500	SDC50	500
SC60	600	SDC60	600
SC80	800	SDC80	800

Excludes chest top  
Excludes chest top

DRAWLINE CABINET

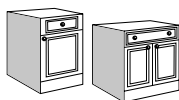

CORNER CABINET

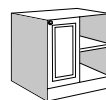

H:778mm	WIDTH
SCC60	600
SCC80	800

Excludes chest top

DRAWER CHEST

2 Drawer



H:778mm	WIDTH
SDC230	300
SDC235	350
SDC240	400
SDC245	450
SDC250	500
SDC260	600
SDC280	800

Excludes chest top  
Two drawers [2x355]

3 Drawer



H:778mm	WIDTH
SDC330	300
SDC335	350
SDC340	400
SDC345	450
SDC350	500
SDC360	600
SDC380	800

Excludes chest top  
Three drawers [2x175 & 1x355]

**DRAWER CHEST**

4 Drawer

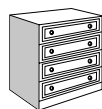

H:778mm

CODE	WIDTH
SDC430	300
SDC435	350
SDC440	400
SDC445	450
SDC450	500
SDC460	600
SDC480	800

Excludes chest top  
Four drawers [4x175]

**BEDSIDE CABINET**



H:598mm

CODE	WIDTH
BSC20	200
BSC30	300
BSC35	350
BSC40	400
BSC45	450
BSC50	500
BSC60	600
BSC80	800

Excludes chest top

**BEDSIDE DRAWER CHEST**

2 Drawer



H:598mm

CODE	WIDTH
BSD230	300
BSD235	350
BSD240	400
BSD245	450
BSD250	500
BSD260	600
BSD280	800

Excludes chest top  
Two drawers [1x175 & 1x355]

3 Drawer



H:598mm

CODE	WIDTH
BSD330	300
BSD335	350
BSD340	400
BSD345	450
BSD350	500
BSD360	600
BSD380	800

Excludes chest top  
Three Drawers [3x175]

**FLOATING DRAWER**

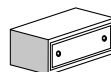

H:359mm

CODE	WIDTH
FBSD40	400
FBSD50	500
FBSD60	600

Excludes chest top  
One drawer [1x355]

**WINDOW SEAT**

1 Drawer



H:418mm

CODE	WIDTH
WDS160	600
WDS180	800

Excludes chest top  
One drawer [1x355]

2 Drawer



H:418mm

CODE	WIDTH
WDS260	600
WDS280	800

Excludes chest top  
Two Drawers [2x175]

**DRESSING TABLE DRAWER**

Single Drawer

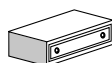

H:180mm

CODE	WIDTH
DTD60	600
DTD70	700
DTD80	800

Excludes chest top  
One drawer [1x175]

**CHEST TOPS**

18mm Foil



Single overhang = one plant-on end panel  
Double overhang = two plant-on end panels

D:520mm

CODE	WIDTH
WT200SO	228
WT200DO	256
WT300SO	328
WT300DO	356
WT350SO	378
WT350DO	406
WT400SO	428

Suits 200 base with Single overhang  
Suits 200 base with Double overhang  
Suits 300 base with Single overhang  
Suits 300 base with Double overhang  
Suits 350 base with Single overhang  
Suits 350 base with Double overhang  
Suits 400 base with Single overhang

CODE	WIDTH
WT400DO	456
WT450SO	478
WT450DO	506
WT500SO	528
WT500DO	556
WT600SO	628
WT600DO	656

Suits 400 base with Double overhang  
Suits 450 base with Single overhang  
Suits 450 base with Double overhang  
Suits 500 base with Single overhang  
Suits 500 base with Double overhang  
Suits 600 base with Single overhang  
Suits 600 base with Double overhang

CODE	WIDTH
WT800SO	828
WT800DO	856
WT1200SO	1228
WT1200DO	1256
WT1600SO	1628
WT1600DO	1656
WT2400	2400

Suits 800 base with Single overhang  
Suits 800 base with Double overhang  
Suits 1200 base with Single overhang  
Suits 1200 base with Double overhang  
Suits 1600 base with Single overhang  
Suits 1600 base with Double overhang

**INTERIOR ROBE**

4 Drawer Chest

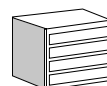

H:735mm

CODE	WIDTH
INT4DR40	400
INT4DR50	500
INT4DR60	600
INT4DR70	700
INT4DR80	800
INT4DR90	900
INT4DR10	1000

Top included

**INTERNAL DIVIDERS**

Standard Height



CODE	WIDTH
ISRD60	600
ISRD70	700
ISRD80	800
ISRD90	900
ISRD10	1000

Consists:  
1 x Vertical Divide & 3 Shelves

Tall Height

CODE	WIDTH
ITRD60	600
ITRD70	700
ITRD80	800
ITRD90	900
ITRD10	1000

Consists:  
1 x Vertical Divide & 3 Shelves

**INTERNAL HANGING RAILS - SPARE**

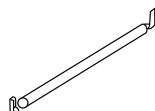

CODE	WIDTH
HR300	300
HR350	350
HR400	400
HR450	450
HR500	500
HR600	600

**INTERNAL SHELVES - SPARE**



CODE	WIDTH
RS300	300
RS350	350
RS400	400
RS450	450
RS500	500
RS600	600

**MODERN CORNICE**



H:33mm

CODE	LENGTH
BCM/O*	3000

Foil

**PLINTH**



L:3000mm

CODE	HEIGHT
BPL60/O*	60
BPL100/O*	100

Scribe to suit on site  
Foil

**INTERIOR MIRROR**



H:1550mm

CODE	WIDTH
IRM	300

Supplied with fixings  
Minimum door width 400

**PLANT ON END PANELS**

18mm MFC



CODE	WIDTH
BP1200/520/O	520x1200
BP2400/655/O	655x2400
BP2800/170/O	170x2800
BP459/665/O	665x459
BP856/520/O	520x856

Tall Boy  
Robe  
Flat pelmet/filler  
Bridging unit  
Base cabinet

**EDGING TAPE**



H:22mm

CODE	WIDTH
10ET/OGT	10mtr
10ET/O	10mtr

Carcase edging / Un-glued  
Plant-on panel/ chest top edging / Pre-glued

BEDROOMS  
PRICE GROUP 3  
**SIENA**

Colours Options: Grey, Oyster and White.



**ROBE**

Standard Height

Tall Height

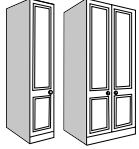

H:2116mm	WIDTH	H:2221mm	WIDTH
<b>SR30</b>	300	<b>TR30</b>	300
<b>SR35</b>	350	<b>TR35</b>	350
<b>SR40</b>	400	<b>TR40</b>	400
<b>SR45</b>	450	<b>TR45</b>	450
<b>SR50</b>	500	<b>TR50</b>	500
<b>SR60*</b>	600	<b>TR60*</b>	600
<b>SR70</b>	700	<b>TR70</b>	700
<b>SR80</b>	800	<b>TR80</b>	800
<b>SR90</b>	900	<b>TR90</b>	900
<b>SR10</b>	1000	<b>TR10</b>	1000

Solid Door  
\*2 x Doors

Solid Door  
\*2 x Doors

Standard Height

Tall Height

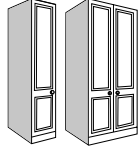

H:2116mm	WIDTH	H:2221mm	WIDTH
<b>SMR40</b>	400	<b>TMR40</b>	400
<b>SMR45</b>	450	<b>TMR45</b>	450
<b>SMR50</b>	500	<b>TMR50</b>	500
<b>SMR80</b>	800	<b>TMR80</b>	800
<b>SMR90</b>	900	<b>TMR90</b>	900
<b>SMR10</b>	1000	<b>TMR10</b>	1000

Mirror Door  
Mirror Door

**CORNER ROBE**

Standard Height

Tall Height

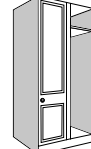

H:2116mm	WIDTH	H:2221mm	WIDTH
<b>SCR60</b>	600	<b>TCR60</b>	600
<b>SCR80</b>	800	<b>TCR80</b>	800
<b>SCR90</b>	900	<b>TCR90</b>	900
<b>SCR10</b>	1000	<b>TCR10</b>	1000

Solid Door  
Solid Door

**ANGLED ROBE**

Standard Height

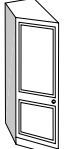

H:2116mm	WIDTH
<b>SAR30</b>	300
<b>SMAR30</b>	300

Mirror Door  
Specify LH or RH  
Supplied with four shelves

**ANGLED ROBE**

Tall Height

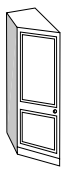

H:2221mm	WIDTH
<b>TAR30</b>	300
<b>TMAR30</b>	300

Solid Door  
Mirror Door  
Specify LH or RH  
Supplied with four shelves

**STABLE ROBE**

Standard Height

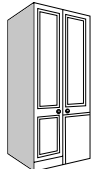

H:2116mm	WIDTH
<b>SSR50</b>	500
<b>SSR10</b>	1000

Specify LH or RH  
RH Shown

**DIAGONAL ROBE**

Standard Height

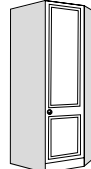

H:2116mm	WIDTH
<b>SDR970</b>	970/970
<b>SMDR970</b>	970/970

Solid Door  
Mirror Door

**COMBINATION ROBE**

Standard Height

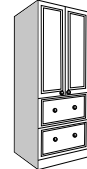

H:2116mm	WIDTH	H:2221mm	WIDTH
<b>SCBR240</b>	400	<b>TCBR240</b>	400
<b>SCBR245</b>	450	<b>TCBR245</b>	450
<b>SCBR250</b>	500	<b>TCBR250</b>	500
<b>SCBR280</b>	800	<b>TCBR280</b>	800
<b>SCBR290</b>	900	<b>TCBR290</b>	900
<b>SCBR210</b>	1000	<b>TCBR210</b>	1000

Two Drawers [2x355]  
Two Drawers [2x355]

**COMBINATION ROBE**

Standard Height

Tall Height

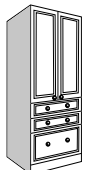

H:2116mm	WIDTH	H:2221mm	WIDTH
<b>SCBR340</b>	400	<b>TCBR340</b>	400
<b>SCBR345</b>	450	<b>TCBR345</b>	450
<b>SCBR350</b>	500	<b>TCBR350</b>	500
<b>SCBR380</b>	800	<b>TCBR380</b>	800
<b>SCBR390</b>	900	<b>TCBR390</b>	900
<b>SCBR310</b>	1000	<b>TCBR310</b>	1000

Three Drawers [2x175 & 1x355]  
Three Drawers [2x175 & 1x355]

Standard Height

Tall Height

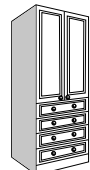

H:2116mm	WIDTH	H:2221mm	WIDTH
<b>SCBR440</b>	400	<b>TCBR440</b>	400
<b>SCBR445</b>	450	<b>TCBR445</b>	450
<b>SCBR450</b>	500	<b>TCBR450</b>	500
<b>SCBR480</b>	800	<b>TCBR480</b>	800
<b>SCBR490</b>	900	<b>TCBR490</b>	900
<b>SCBR410</b>	1000	<b>TCBR410</b>	1000

Four Drawers [4x175]  
Four Drawers [4x175]

**TALL BOY CHEST**

3 Drawers

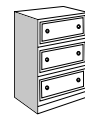

H:1137mm	WIDTH
<b>TBDC360</b>	600
<b>TBDC380</b>	800

Three Drawers [3x355]

4 Drawers

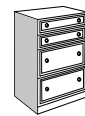

H:1137mm	WIDTH
<b>TBDC460</b>	600
<b>TBDC480</b>	800

Four Drawers [2x175 & 2x355]

6 Drawers

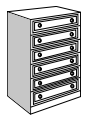

H:1137mm	WIDTH
<b>TBDC660</b>	600
<b>TBDC680</b>	800

Six Drawers [6x175]

**BRIDGING UNIT**

Scribing Panel

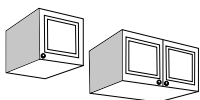

H:459mm	WIDTH	H:2400mm	WIDTH
<b>BU40</b>	400	<b>BP2400/655/O</b>	655
<b>BU45</b>	450		
<b>BU50</b>	500		
<b>BU80</b>	800		
<b>BU90</b>	900		
<b>BU10</b>	1000		

Fit to the underside of bridging units to match plant-on end panels  
Foil

**STANDARD CABINET**

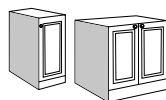

H:778mm	WIDTH
<b>SC30</b>	300
<b>SC35</b>	350
<b>SC40</b>	400
<b>SC45</b>	450
<b>SC50</b>	500
<b>SC60</b>	600
<b>SC80</b>	800

Excludes chest top

**DRAWLINE CABINET**

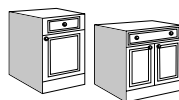

H:778mm	WIDTH
<b>SDC30</b>	300
<b>SDC35</b>	350
<b>SDC40</b>	400
<b>SDC45</b>	450
<b>SDC50</b>	500
<b>SDC60</b>	600
<b>SDC80</b>	800

Excludes chest top

**CORNER CABINET**

Standard

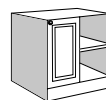

H:778mm	WIDTH
<b>SCC60</b>	600
<b>SCC80</b>	800

Excludes chest top

**DRAWER CHEST**

2 Drawer



H:778mm	WIDTH
<b>SDC230</b>	300
<b>SDC235</b>	350
<b>SDC240</b>	400
<b>SDC245</b>	450
<b>SDC250</b>	500
<b>SDC260</b>	600
<b>SDC280</b>	800

Excludes chest top  
Two drawers [2x355]

3 Drawer



H:778mm	WIDTH
<b>SDC330</b>	300
<b>SDC335</b>	350
<b>SDC340</b>	400
<b>SDC345</b>	450
<b>SDC350</b>	500
<b>SDC360</b>	600
<b>SDC380</b>	800

Excludes chest top  
Three drawers [2x175 & 1x355]

**DRAWER CHEST**

4 Drawer

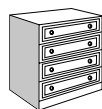

H:778mm

CODE	WIDTH
SDC430	300
SDC435	350
SDC440	400
SDC445	450
SDC450	500
SDC460	600
SDC480	800

Excludes chest top  
Four drawers [4x175]

**BEDSIDE CABINET**



H:598mm

CODE	WIDTH
BSC20	200
BSC30	300
BSC35	350
BSC40	400
BSC45	450
BSC50	500
BSC60	600
BSC80	800

Excludes chest top

**BEDSIDE DRAWER CHEST**

2 Drawer



H:598mm

CODE	WIDTH
BSD230	300
BSD235	350
BSD240	400
BSD245	450
BSD250	500
BSD260	600
BSD280	800

Excludes chest top  
Two drawers [1x175 & 1x355]

3 Drawer



H:598mm

CODE	WIDTH
BSD330	300
BSD335	350
BSD340	400
BSD345	450
BSD350	500
BSD360	600
BSD380	800

Excludes chest top  
Three Drawers [3x175]

**FLOATING DRAWER**

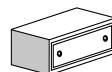

H:359mm

CODE	WIDTH
FBSD40	400
FBSD50	500
FBSD60	600

Excludes chest top  
One drawer [1x355]

**WINDOW SEAT**

1 Drawer



H:418mm

CODE	WIDTH
WDS160	600
WDS180	800

Excludes chest top  
One drawer [1x355]

2 Drawer



H:418mm

CODE	WIDTH
WDS260	600
WDS280	800

Excludes chest top  
Two Drawers [2x175]

**DRESSING TABLE DRAWER**

Single Drawer

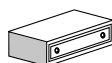

H:180mm

CODE	WIDTH
DTD60	600
DTD70	700
DTD80	800

Excludes chest top  
One drawer [1x175]

**CHEST TOPS**

18mm Foil



Single overhang = one plant-on end panel  
Double overhang = two plant-on end panels

D:520mm

CODE	WIDTH
WT200SO	228
WT200DO	256
WT300SO	328
WT300DO	356
WT350SO	378
WT350DO	406
WT400SO	428

Suits 200 base with Single overhang  
Suits 200 base with Double overhang  
Suits 300 base with Single overhang  
Suits 300 base with Double overhang  
Suits 350 base with Single overhang  
Suits 350 base with Double overhang  
Suits 400 base with Single overhang

CODE	WIDTH
WT400DO	456
WT450SO	478
WT450DO	506
WT500SO	528
WT500DO	556
WT600SO	628
WT600DO	656

Suits 400 base with Double overhang  
Suits 450 base with Single overhang  
Suits 450 base with Double overhang  
Suits 500 base with Single overhang  
Suits 500 base with Double overhang  
Suits 600 base with Single overhang  
Suits 600 base with Double overhang

CODE	WIDTH
WT800SO	828
WT800DO	856
WT1200SO	1228
WT1200DO	1256
WT1600SO	1628
WT1600DO	1656
WT2400	2400

Suits 800 base with Single overhang  
Suits 800 base with Double overhang  
Suits 1200 base with Single overhang  
Suits 1200 base with Double overhang  
Suits 1600 base with Single overhang  
Suits 1600 base with Double overhang

**INTERIOR ROBE**

4 Drawer Chest

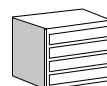

H:735mm

CODE	WIDTH
INT4DR40	400
INT4DR50	500
INT4DR60	600
INT4DR70	700
INT4DR80	800
INT4DR90	900
INT4DR10	1000

Top included

**INTERNAL DIVIDERS**

Standard Height



CODE	WIDTH
ISRD60	600
ISRD70	700
ISRD80	800
ISRD90	900
ISRD10	1000

Consists:  
1 x Vertical Divide & 3 Shelves

Tall Height

CODE	WIDTH
ITRD60	600
ITRD70	700
ITRD80	800
ITRD90	900
ITRD10	1000

Consists:  
1 x Vertical Divide & 3 Shelves

**INTERNAL HANGING RAILS - SPARE**

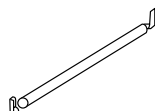

CODE	WIDTH
HR300	300
HR350	350
HR400	400
HR450	450
HR500	500
HR600	600

**INTERNAL SHELVES - SPARE**



CODE	WIDTH
RS300	300
RS350	350
RS400	400
RS450	450
RS500	500
RS600	600

**MODERN CORNICE**



H:33mm

CODE	LENGTH
BCM/O*	3000

Foil

**PLINTH**



L:3000mm

CODE	HEIGHT
BPL60/O*	60
BPL100/O*	100

Scribe to suit on site  
Foil

**INTERIOR MIRROR**

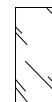

H:1550mm

CODE	WIDTH
IRM	300

Supplied with fixings  
Minimum door width 400

**PLANT ON END PANELS**

18mm MFC



CODE	WIDTH
BP1200/520/O	520x1200
BP2400/655/O	655x2400
BP2800/170/O	170x2800
BP459/665/O	665x459
BP856/520/O	520x856

Tall Boy  
Robe  
Flat pelmet/filler  
Bridging unit  
Base cabinet

**EDGING TAPE**



H:22mm

CODE	WIDTH
10ET/OGT	10mtr
10ET/O	10mtr

Carcase edging / Un-glued  
Plant-on panel/ chest top edging / Pre-glued



BEDROOMS

PRICE GROUP 6

# SORRENTO

Colours Options: Grey, Oyster, Stone and White.



ROBE

Standard Height

Tall Height

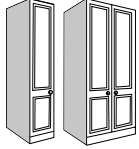

H:2116mm		H:2221mm	
CODE	WIDTH	CODE	WIDTH
SR30	300	TR30	300
SR35	350	TR35	350
SR40	400	TR40	400
SR45	450	TR45	450
SR50	500	TR50	500
SR60*	600	TR60*	600
SR70	700	TR70	700
SR80	800	TR80	800
SR90	900	TR90	900
SR10	1000	TR10	1000

Solid Door  
\*2 x Doors

Solid Door  
\*2 x Doors

Standard Height

Tall Height

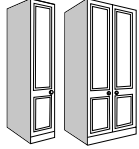

H:2116mm		H:2221mm	
CODE	WIDTH	CODE	WIDTH
SMR40	400	TMR40	400
SMR45	450	TMR45	450
SMR50	500	TMR50	500
SMR80	800	TMR80	800
SMR90	900	TMR90	900
SMR10	1000	TMR10	1000

Mirror Door  
Mirror Door

Mirror Door  
Mirror Door

CORNER ROBE

Standard Height

Tall Height

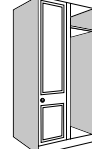

H:2116mm		H:2221mm	
CODE	WIDTH	CODE	WIDTH
SCR60	600	TCR60	600
SCR80	800	TCR80	800
SCR90	900	TCR90	900
SCR10	1000	TCR10	1000

Solid Door  
Solid Door

SMCR80\* 800  
SMCR90\* 900  
SMCR10\* 1000  
Mirror Door

TMCR80 800  
TMCR90 900  
TMCR10 1000  
Mirror Door

ANGLED ROBE

Standard Height

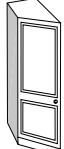

H:2116mm	
CODE	WIDTH
SAR30	300
SMAR30	300

Solid Door  
Mirror Door  
Specify LH or RH  
Supplied with four shelves

ANGLED ROBE

Tall Height

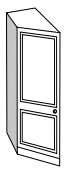

H:2221mm	
CODE	WIDTH
TAR30	300
TMAR30	300

Solid Door  
Mirror Door

Specify LH or RH  
Supplied with four shelves

STABLE ROBE

Standard Height

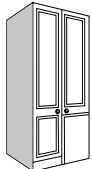

H:2116mm	
CODE	WIDTH
SSR50	500
SSR10	1000

Specify LH or RH  
RH Shown

DIAGONAL ROBE

Standard Height

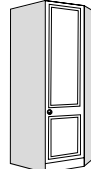

H:2116mm	
CODE	WIDTH
SDR970	970/970
SMDR970	970/970

Solid Door  
Mirror Door

COMBINATION ROBE

Standard Height

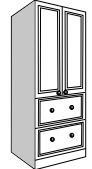

H:2116mm	
CODE	WIDTH
SCBR240	400
SCBR245	450
SCBR250	500
SCBR280	800
SCBR290	900
SCBR210	1000

Two Drawers [2x355]

Tall Height

H:2221mm	
CODE	WIDTH
TCBR240	400
TCBR245	450
TCBR250	500
TCBR280	800
TCBR290	900
TCBR210	1000

Two Drawers [2x355]

COMBINATION ROBE

Standard Height

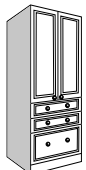

H:2116mm	
CODE	WIDTH
SCBR340	400
SCBR345	450
SCBR350	500
SCBR380	800
SCBR390	900
SCBR310	1000

Three Drawers [2x175 & 1x355]

Tall Height

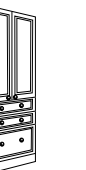

H:2221mm	
CODE	WIDTH
TCBR340	400
TCBR345	450
TCBR350	500
TCBR380	800
TCBR390	900
TCBR310	1000

Three Drawers [2x175 & 1x355]

Standard Height

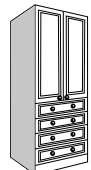

H:2116mm	
CODE	WIDTH
SCBR440	400
SCBR445	450
SCBR450	500
SCBR480	800
SCBR490	900
SCBR410	1000

Four Drawers [4x175]

Tall Height

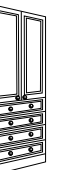

H:2221mm	
CODE	WIDTH
TCBR440	400
TCBR445	450
TCBR450	500
TCBR480	800
TCBR490	900
TCBR410	1000

Four Drawers [4x175]

TALL BOY CHEST

3 Drawers



H:1137mm	
CODE	WIDTH
TBDC360	600
TBDC380	800

Three Drawers [3x355]

4 Drawers

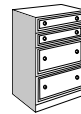

H:1137mm	
CODE	WIDTH
TBDC460	600
TBDC480	800

Four Drawers [2x175 & 2x355]

6 Drawers

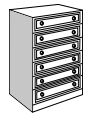

H:1137mm	
CODE	WIDTH
TBDC660	600
TBDC680	800

Six Drawers [6x175]

BRIDGING UNIT

Scribing Panel

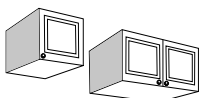

H:459mm		H:2400mm	
CODE	WIDTH	CODE	WIDTH
BU40	400	BP2400/655/OG	655
BU45	450		
BU50	500		
BU80	800		
BU90	900		
BU10	1000		

Fit to the underside of bridging units to match plant-on end panels  
Gloss

STANDARD CABINET

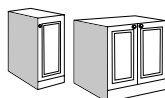

H:778mm		H:778mm	
CODE	WIDTH	CODE	WIDTH
SC30	300	SDC30	300
SC35	350	SDC35	350
SC40	400	SDC40	400
SC45	450	SDC45	450
SC50	500	SDC50	500
SC60	600	SDC60	600
SC80	800	SDC80	800

Excludes chest top  
Excludes chest top

DRAWLINE CABINET

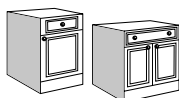

CORNER CABINET

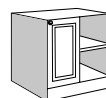

H:778mm	
CODE	WIDTH
SCC60	600
SCC80	800

Excludes chest top

DRAWER CHEST

2 Drawer



H:778mm	
CODE	WIDTH
SDC230	300
SDC235	350
SDC240	400
SDC245	450
SDC250	500
SDC260	600
SDC280	800

Excludes chest top  
Two drawers [2x355]

3 Drawer



H:778mm	
CODE	WIDTH
SDC330	300
SDC335	350
SDC340	400
SDC345	450
SDC350	500
SDC360	600
SDC380	800

Excludes chest top  
Three drawers [2x175 & 1x355]

**DRAWER CHEST**

4 Drawer

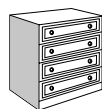

H:778mm

CODE	WIDTH
SDC430	300
SDC435	350
SDC440	400
SDC445	450
SDC450	500
SDC460	600
SDC480	800

Excludes chest top  
Four drawers [4x175]

**BEDSIDE CABINET**



H:598mm

CODE	WIDTH
BSC20	200
BSC30	300
BSC35	350
BSC40	400
BSC45	450
BSC50	500
BSC60	600
BSC80	800

Excludes chest top

**BEDSIDE DRAWER CHEST**

2 Drawer



H:598mm

CODE	WIDTH
BSD230	300
BSD235	350
BSD240	400
BSD245	450
BSD250	500
BSD260	600
BSD280	800

Excludes chest top  
Two drawers [1x175 & 1x355]

3 Drawer



H:598mm

CODE	WIDTH
BSD330	300
BSD335	350
BSD340	400
BSD345	450
BSD350	500
BSD360	600
BSD380	800

Excludes chest top  
Three Drawers [3x175]

**FLOATING DRAWER**

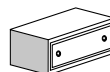

H:359mm

CODE	WIDTH
FBSD40	400
FBSD50	500
FBSD60	600

Excludes chest top  
One drawer [1x355]

**WINDOW SEAT**

1 Drawer



H:418mm

CODE	WIDTH
WDS160	600
WDS180	800

Excludes chest top  
One drawer [1x355]

2 Drawer



H:418mm

CODE	WIDTH
WDS260	600
WDS280	800

Excludes chest top  
Two Drawers [2x175]

**DRESSING TABLE DRAWER**

Single Drawer

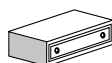

H:180mm

CODE	WIDTH
DTD60	600
DTD70	700
DTD80	800

Excludes chest top  
One drawer [1x175]

**CHEST TOPS**

18mm Gloss



Single overhang = one plant-on end panel  
Double overhang = two plant-on end panels

D:520mm

CODE	WIDTH
WT200SO	228
WT200DO	256
WT300SO	328
WT300DO	356
WT350SO	378
WT350DO	406
WT400SO	428

Suits 200 base with Single overhang  
Suits 200 base with Double overhang  
Suits 300 base with Single overhang  
Suits 300 base with Double overhang  
Suits 350 base with Single overhang  
Suits 350 base with Double overhang  
Suits 400 base with Single overhang

CODE	WIDTH
WT400DO	456
WT450SO	478
WT450DO	506
WT500SO	528
WT500DO	556
WT600SO	628
WT600DO	656

Suits 400 base with Double overhang  
Suits 450 base with Single overhang  
Suits 450 base with Double overhang  
Suits 500 base with Single overhang  
Suits 500 base with Double overhang  
Suits 600 base with Single overhang  
Suits 600 base with Double overhang

CODE	WIDTH
WT800SO	828
WT800DO	856
WT1200SO	1228
WT1200DO	1256
WT1600SO	1628
WT1600DO	1656
WT2400	2400

Suits 800 base with Single overhang  
Suits 800 base with Double overhang  
Suits 1200 base with Single overhang  
Suits 1200 base with Double overhang  
Suits 1600 base with Single overhang  
Suits 1600 base with Double overhang

**INTERIOR ROBE**

4 Drawer Chest

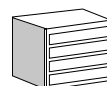

H:735mm

CODE	WIDTH
INT4DR40	400
INT4DR50	500
INT4DR60	600
INT4DR70	700
INT4DR80	800
INT4DR90	900
INT4DR10	1000

Top included

**INTERNAL DIVIDERS**

Standard Height



CODE	WIDTH
ISRD60	600
ISRD70	700
ISRD80	800
ISRD90	900
ISRD10	1000

Consists:  
1 x Vertical Divide & 3 Shelves

Tall Height

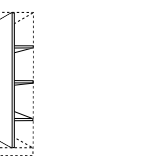

CODE	WIDTH
ITRD60	600
ITRD70	700
ITRD80	800
ITRD90	900
ITRD10	1000

Consists:  
1 x Vertical Divide & 3 Shelves

**INTERNAL HANGING RAILS - SPARE**

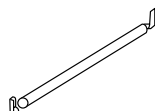

CODE	WIDTH
HR300	300
HR350	350
HR400	400
HR450	450
HR500	500
HR600	600

**INTERNAL SHELVES - SPARE**



CODE	WIDTH
RS300	300
RS350	350
RS400	400
RS450	450
RS500	500
RS600	600

**MODERN CORNICE**



H:33mm

CODE	LENGTH
BCM/OG*	3000

Gloss

**PLINTH**



L:3000mm

CODE	HEIGHT
BPL60/OG*	60
BPL100/OG*	100

Scribe to suit on site  
Gloss

**INTERIOR MIRROR**



H:1550mm

CODE	WIDTH
IRM	300

Supplied with fixings  
Minimum door width 400

**PLANT ON END PANELS**

18mm Gloss



CODE	WIDTH
BP1200/520/OG	520x1200
BP2400/655/OG	655x2400
BP2800/170/OG	170x2800
BP459/665/OG	665x459
BP856/520/OG	520x856

Tall Boy  
Robe  
Flat pelmet/filler  
Bridging unit  
Base cabinet

**EDGING TAPE**



H:22mm

CODE	WIDTH
10ET/OGT	10mtr
10ET/O	10mtr

Carcase edging / Un-glued  
Plant-on panel/ chest top edging / Pre-glued





# Handles.

Will it be contemporary linear stainless steel, or a set of traditional pewter knobs? It's amazing how these small [and essential] items can completely transform the finish of your kitchen. Choose the handle that best fits the character of your kitchen, from professional-industrial to Victorian charm.

It's not simply about opening the doors - it's about completing the look.



# Bar Handles

Our collection of bar handles come in a variety of styles, sizes and colours, from traditional through to on-trend metallics to provide the perfect finishing touch and refinement to any kitchen.



MATT BLACK BOW HANDLE

CODE	WIDTH
H325	208



BRUSHED IRON D HANDLE

CODE	WIDTH
H365	204



ANTIQUÉ COPPER BOW HANDLE

CODE	WIDTH
H233	208



BRUSHED NICKEL D HANDLE

CODE	WIDTH
H366	204



BRUSHED IRON BOW HANDLE

CODE	WIDTH
H363	208



ANTIQUÉ COPPER D HANDLE

CODE	WIDTH
H367	204



BRUSHED NICKEL BOW HANDLE

CODE	WIDTH
H268	208



BRUSHED COPPER D HANDLE

CODE	WIDTH
H368	204



BRUSHED COPPER BOW HANDLE

CODE	WIDTH
H260	208





SATIN BRASS FLUTED BAR HANDLE

CODE	WIDTH
H369	264



ANTHRACITE KNURLED BAR HANDLE

CODE	WIDTH
H333	190



BRUSHED SATIN BRASS KNURLED BAR HANDLE

CODE	WIDTH
H290	200



BLACK KNURLED BAR HANDLE

CODE	WIDTH
H288	200



CHROME KNURLED BAR HANDLE

CODE	WIDTH
H289	200



MATT BLACK SLIM D HANDLE

CODE	WIDTH
H314	172



BRUSHED BRASS SLIM D HANDLE

CODE	WIDTH
H300	138



ANTIQUÉ COPPER D HANDLE

CODE	WIDTH
H348	188



BRUSHED NICKEL D HANDLE

CODE	WIDTH
H298	168



ANTIQUÉ COPPER D HANDLE

CODE	WIDTH
H297	168

# Bar Handles

Our collection of bar handles come in a variety of styles, sizes and colours, from traditional through to on-trend metallics to provide the perfect finishing touch and refinement to any kitchen.



SATIN BRASS FLAT BAR HANDLE

CODE	WIDTH
H345	214



MATT BLACK SLIM D HANDLE

CODE	WIDTH
H284	172



BRUSHED SATIN BRASS PULL HANDLE

CODE	WIDTH
H347	160



MATT BLACK BAR HANDLE

CODE	WIDTH
H343	170



MATT BLACK PULL HANDLE

CODE	WIDTH
H320	160



BLACK KNURLED BAR HANDLE AND BACKPLATE

CODE	WIDTH
H305	190



BRUSHED SATIN BRASS BAR HANDLE

CODE	WIDTH
H357	128



ANTIQUE BRASS KNURLED BAR HANDLE AND BACKPLATE

CODE	WIDTH
H304	190



CHROME BAR HANDLE

CODE	WIDTH
H359	128



CHROME PULL HANDLE

CODE	WIDTH
H321	214



SATIN NICKEL LINEAR HANDLE

CODE	WIDTH
H236	256



IRON SQUARE BAR HANDLE

CODE	WIDTH
H340	202
H341	234



STAINLESS STEEL LINEAR HANDLE

CODE	WIDTH
H186	188



BRUSHED NICKEL CHUNKY D HANDLE

CODE	WIDTH
H200A	166



STAINLESS STEEL BAR HANDLE

CODE	WIDTH	CODE	WIDTH
H160	168	H163	488
H161	232		



FLAT CHROME BAR HANDLE

CODE	WIDTH
H338	206
H339	270



CHROME LINEAR HANDLE

CODE	WIDTH
H237	256



STAINLESS STEEL BOW SHAPED HANDLE

CODE	WIDTH
H181	180



STAINLESS STEEL EFFECT BAR HANDLE

CODE	WIDTH
H291	167



SATIN NICKEL STRAP HANDLE

CODE	WIDTH
H219	140



POLISHED CHROME ARC HANDLE

CODE	WIDTH
H251	200

# Knobs

Our range of kitchen knobs come in a variety of styles, button, flat, round, square and T-bar in a variety of colours and finishes and have accompanying bar handles to match.



**BRUSHED COPPER  
FLAT KNOB**

CODE	WIDTH
H259	35



**ANTIQUÉ COPPER  
FLAT KNOB**

CODE	WIDTH
H232	35



**BRUSHED IRON  
FLAT KNOB**

CODE	WIDTH
H364	35



**BRUSHED NICKEL  
FLAT KNOB**

CODE	WIDTH
H267	35



**MATT BLACK  
FLAT KNOB**

CODE	WIDTH
H313	35



**BRUSHED SATIN  
BRASS BUTTON KNOB**

CODE	WIDTH
H283	38



**BRUSHED COPPER  
BUTTON KNOB**

CODE	WIDTH
H263	38



**ANTIQUÉ COPPER  
BUTTON KNOB**

CODE	WIDTH
H234	38



**MATT BLACK  
BUTTON KNOB**

CODE	WIDTH
H312	38



**GUNMETAL  
KNOB**

CODE	WIDTH
H337	38



**IRON EFFECT  
BUTTON KNOB**

CODE	WIDTH
H362	38



**PEWTER EFFECT  
KNOB**

CODE	WIDTH
H180	33



**POLISHED NICKEL  
KNOB**

CODE	WIDTH
H248	32



**BRUSHED NICKEL  
BUTTON KNOB**

CODE	WIDTH
H269	38



**CHROME  
BUTTON KNOB**

CODE	WIDTH
H250A	38



**CHROME  
BUTTON KNOB**

CODE	WIDTH
H216	31



**ANTIQUÉ BRASS  
KNURLED KNOB**

CODE	WIDTH
H342	35



**SATIN BRASS  
KNURLED KNOB**

CODE	WIDTH
H327	30



**BLACK  
KNURLED KNOB**

CODE	WIDTH
H326	30



**CHROME  
KNURLED KNOB**

CODE	WIDTH
H328	30



**ANTHRACITE  
KNURLED KNOB**

CODE	WIDTH
H335	35



BLACK KNURLED KNOB

CODE	WIDTH
H309	35



CHROME FLAT KNOB

CODE	WIDTH
H322	38



SATIN BRASS FLAT KNOB

CODE	WIDTH
H344	38



BRUSHED SATIN BRASS KNOB + BACKPLATE

CODE	WIDTH
H358	58



CHROME KNOB + BACKPLATE

CODE	WIDTH
H360	58



SATIN BRASS FLUTED KNOB

CODE	WIDTH
H370	30



BRUSHED SATIN BRASS KNOB

CODE	WIDTH
H354	35



ANTIQUÉ COPPER KNOB

CODE	WIDTH
H353	35



BRUSHED NICKEL KNOB

CODE	WIDTH
H355	35



BRUSHED IRON KNOB

CODE	WIDTH
H356	35



BRUSHED SATIN BRASS KNURLED CYLINDER KNOB

CODE	WIDTH
H287	30



BLACK KNURLED CYLINDER KNOB

CODE	WIDTH
H285	30



CHROME KNURLED CYLINDER KNOB

CODE	WIDTH
H286	30



BRUSHED SATIN BRASS 'T' BAR KNOB

CODE	WIDTH
H346	56



MATT BLACK 'T' BAR KNOB

CODE	WIDTH
H319	56



SATIN BRASS KNOB

CODE	WIDTH
H293	60



ANTIQUÉ COPPER KNOB

CODE	WIDTH
H294	60



BRUSHED NICKEL KNOB

CODE	WIDTH
H295	60



STAINLESS STEEL EFFECT 'T' BAR KNOB

CODE	WIDTH
H247	60



ANTIQUÉ KNURLED 'T' BAR KNOB

CODE	WIDTH
H334	50



SATIN BRASS KNURLED 'T' BAR KNOB

CODE	WIDTH
H331	50



BLACK KNURLED 'T' BAR KNOB

CODE	WIDTH
H330	50



CHROME KNURLED 'T' BAR KNOB

CODE	WIDTH
H332	50



ANTIQUÉ BRASS KNURLED 'T' BAR KNOB

CODE	WIDTH
H306	54



BLACK KNURLED 'T' BAR KNOB

CODE	WIDTH
H307	54



# Cup Handles

A classic alternative to bar handles and knobs, our range of cup handles look equally at home in either traditional or contemporary kitchens and with a range of colours and finishes there's something for everyone.



IRON EFFECT CUP HANDLE

CODE	WIDTH
H361	104



MATT BLACK CUP HANDLE

CODE	WIDTH
H311	104



ANTIQUÉ COPPER CUP HANDLE

CODE	WIDTH
H212	104



GUNMETAL CUP HANDLE

CODE	WIDTH
H336	91



BRUSHED SATIN BRASS CUP HANDLE

CODE	WIDTH
H282	104



BRUSHED COPPER CUP HANDLE

CODE	WIDTH
H266	104



CHROME CUP HANDLE

CODE	WIDTH
H303	104



BRUSHED NICKEL CUP HANDLE

CODE	WIDTH
H270	104



POLISHED NICKEL CUP HANDLE

CODE	WIDTH
H215	104



CHROME EFFECT CUP HANDLE

CODE	WIDTH
H242	91



ANTIQUÉ COPPER CUP HANDLE

CODE	WIDTH
H349	124



BRUSHED SATIN BRASS CUP HANDLE

CODE	WIDTH
H350	124



BRUSHED NICKEL CUP HANDLE

CODE	WIDTH
H351	124



CHROME CUP HANDLE

CODE	WIDTH
H352	124

# Trim Handles

Our collection of trim handles are available in a selection of sizes and are finished in a range of contemporary colours - perfect for those looking for a sleek, minimalist finish and are a great alternative to a handleless rail system.



ALUMINIUM FLAT TRIM HANDLE

CODE	WIDTH
H171	220



BRUSHED ANTHRACITE TAPERED TRIM HANDLE

CODE	WIDTH
H275	200



BRUSHED MATT BLACK TAPERED TRIM HANDLE

CODE	WIDTH
H273	200



BRUSHED BRASS TAPERED TRIM HANDLE

CODE	WIDTH
H277	200



BRUSHED ROSE GOLD TAPERED TRIM HANDLE

CODE	WIDTH
H271	200



BRUSHED BRASS TAPERED TRIM HANDLE

CODE	WIDTH
H278	40



BRUSHED ANTHRACITE TAPERED TRIM HANDLE

CODE	WIDTH
H276	40



BRUSHED ROSE GOLD TAPERED TRIM HANDLE

CODE	WIDTH
H272	40



BRUSHED MATT BLACK TAPERED TRIM HANDLE

CODE	WIDTH
H274	40



BRUSHED ALUMINIUM EFFECT TAPERED TRIM HANDLE

CODE	WIDTH
H244	40

# Caple Care

The Caple Care Protection plan has been carefully put together to offer you that extra peace of mind.

As the hub of the home, the kitchen is considered the most important room in the house. With this in mind and for that added security, Caple provided a free 5 year guarantee on kitchen furniture as standard to ensure you have complete confidence when investing in your home.







Fourth Way  
Avonmouth  
Bristol  
BS11 8DW

t: 0117 938 1900  
f: 0800 373 163  
e: sales@caple.co.uk  
caple.co.uk



Issue: CA0524

